

ACCROSSATO[®] *Racing*

M A D E I N I T A L Y



- BRAKE/CLUTCH MASTER CYLINDERS
- ACCESSORIES SPARE PARTS
- CNC-WORKED FLUID RESERVOIR
- FULL CLUTCH
- HYDRAULIC-CLUTCH TRANSFORMATION KIT
- LEVER
- THROTTLE CONTROL
- BRAKE CALIPER
- RACING KIT
- BUTTON PANEL
- LEVER GUARD
- CLIP-ON
- STREET RACING REARSET
- FUEL CAPS
- STEERING NUT
- CRASH PADS
- Paddock STAND
- MIRROR COVERS
- REAR-VIEW MIRRORS
- FOG LIGHTS KIT
- HANDLEBARS ACCESSORIES
- HANDLEBARS

BRAKE/CLUTCH
MASTER CYLINDERS

ACCESSORIES
SPARE PARTS

CNC-WORKED FLUID
RESERVOIR

FULL CLUTCH

HYDRAULIC-CLUTCH
TRANFORMATION KIT

LEVER

THROTTLE CONTROL

BRAKE CALIPER

RACING KIT

BUTTON PANEL

LEVER GUARD

CLIP-ON

STREET RACING
REARSET

FUEL CAPS

STEERING NUT

CRASH PADS

Paddock STAND

MIRROR COVERS

REAR-VIEW MIRRORS

FOG LIGHTS KIT

HANDLEBARS
ACCESSORIES

HANDLEBARS

PARTNER OF:



- BRAKE/CLUTCH MASTER CYLINDERS
- ACCESSORIES SPARE PARTS
- CNC-WORKED FLUID RESERVOIR
- FULL CLUTCH
- HYDRAULIC-CLUTCH TRANFORMATION KIT
- LEVER
- THROTTLE CONTROL
- BRAKE CALIPER
- RACING KIT
- BUTTON PANEL
- LEVER GUARD
- CLIP-ON
- STREET RACING REARSET
- FUEL CAPS
- STEERING NUT
- CRASH PADS
- PADDOCK STAND
- MIRROR COVERS
- REAR-VIEW MIRRORS
- FOG LIGHTS KIT
- HANDLEBARS ACCESSORIES
- HANDLEBARS

BRAKE/CLUTCH
MASTER CYLINDERS

ACCESSORIES
SPARE PARTS

CNC-WORKED FLUID
RESERVOIR

FULL CLUTCH

HYDRAULIC-CLUTCH
TRANFORMATION KIT

LEVER

THROTTLE CONTROL

BRAKE CALIPER

RACING KIT

BUTTON PANEL

LEVER GUARD

CLIP-ON

STREET RACING
REARSET

FUEL CAPS

STEERING NUT

CRASH PADS

Paddock STAND

MIRROR COVERS

REAR-VIEW MIRRORS

FOG LIGHTS KIT

HANDLEBARS
ACCESSORIES

HANDLEBARS



Accossato è una azienda situata nel Nord dell'Italia che si occupa della produzione di ricambi ed accessori moto per il mercato aftermarket e che collabora con le maggiori case motociclistiche a livello mondiale realizzando prodotti su loro disegno.

Accossato è una azienda storica, nata nel 1969 su idea di Giovanni Accossato, come produttore di motociclette, nella loro storia le moto Accossato hanno vinto 1 campionato del mondo ,3 europei e 12 campionati italiani. Nell'anno della vittoria del campionato del mondo (1984) Accossato ha costruito le parti più importanti della moto come ad esempio la telaistica, ma anche il motore. Parallelamente alla produzione di motociclette, l'azienda ha iniziato a costruire componenti per moto fino poi a scegliere dopo la vittoria del mondiale di ritirarsi da vincitrice dedicandosi esclusivamente alla fornitura di particolari per le più importanti case motociclistiche mondiali.

La grande esperienza di oltre 50 anni ha concesso di avere una relazione diretta con l'azienda. Essendo un costruttore e non acquistando i prodotti all'estero Accossato è in grado in ogni momento di fornire assistenza tecnica a tutti i suoi Clienti. Acquistare un prodotto Accossato Made in Italy renderà l'esperienza di acquisto unica nel suo genere sia per quanto riguarda la qualità che il servizio offerto. Ogni anno Accossato protegge il proprio brand in tutto il mondo e realizza brevetti difendendo tutte le proprie invenzioni al meglio.

La nostra missione è fornire ai nostri Clienti di tutto il mondo il miglior prodotto come rapporto qualità/prezzo soprattutto per quanto riguarda la produzione degli impianti frenanti e diventare la vera alternativa al brand attuale in tutti i campionati sportivi nonché la MotoGP.

Accossato is a company located in Northern Italy focused on motorcycle spare parts and accessories for the aftermarket and we collaborate with the main global motorcycle producers and we realise products based on their designs.

Accossato is a historical company, founded in 1969 by Giovanni Accossato, as a motorcycle producer. Over the years, Accossato motorbikes have won a World championship, 3 European championships as well as 12 Italian championships.

In 1984 we won the World championship as well as we have designed the major parts of the motorcycle such as the frame building and the engine.

Together with the production of motorcycles, the company has started to manufacture spare parts. After its winning of the global championship we have decided to focus only on supplying components for the main global motorcycle producers.

During our over 50 years of expertise we have developed special skills in having a direct relationship with companies. We are a manufacturing company of motorcycle spare parts 100% made in Italy and we always provide technical assistance to our clients. Purchasing Accossato products is a unique experience that joins the high quality of our products and after-sales support.

Every year Accossato protects its brand worldwide and patents its name in order to fully protect its designs and inventions.

Our mission is to provide our clients worldwide products with the best quality / price ratio especially as regards the production of brake systems and to become the first and best option in all sports championships and MotoGP.

BRAKE/CLUTCH
MASTER CYLINDERS

ACCESSORIES
SPARE PARTS

CNC-WORKED FLUID
RESERVOIR

FULL CLUTCH

HYDRAULIC-CLUTCH
TRANSFORMATION KIT

LEVER

THROTTLE CONTROL

BRAKE CALIPER

RACING KIT

BUTTON PANEL

LEVER GUARD

CLIP-ON

STREET RACING
REARSET

FUEL CAPS

STEERING NUT

CRASH PADS

PADDOCK STAND

MIRROR COVERS

REAR-VIEW MIRRORS

FOG LIGHTS KIT

HANDLEBARS
ACCESSORIES

HANDLEBARS



- BRAKE/CLUTCH MASTER CYLINDERS
- ACCESSORIES SPARE PARTS
- CNC-WORKED FLUID RESERVOIR
- FULL CLUTCH
- HYDRAULIC-CLUTCH TRANFORMATION KIT
- LEVER
- THROTTLE CONTROL
- BRAKE CALIPER
- RACING KIT
- BUTTON PANEL
- LEVER GUARD
- CLIP-ON
- STREET RACING REARSET
- FUEL CAPS
- STEERING NUT
- CRASH PADS
- PADDOCK STAND
- MIRROR COVERS
- REAR-VIEW MIRRORS
- FOG LIGHTS KIT
- HANDLEBARS ACCESSORIES
- HANDLEBARS



- BRAKE/CLUTCH MASTER CYLINDERS
- ACCESSORIES SPARE PARTS
- CNC-WORKED FLUID RESERVOIR
- FULL CLUTCH
- HYDRAULIC-CLUTCH TRANFORMATION KIT
- LEVER
- THROTTLE CONTROL
- BRAKE CALIPER
- RACING KIT
- BUTTON PANEL
- LEVER GUARD
- CLIP-ON
- STREET RACING REARSET
- FUEL CAPS
- STEERING NUT
- CRASH PADS
- Paddock STAND
- MIRROR COVERS
- REAR-VIEW MIRRORS
- FOG LIGHTS KIT
- HANDLEBARS ACCESSORIES
- HANDLEBARS



BRAKE/CLUTCH
MASTER CYLINDERS

ACCESSORIES
SPARE PARTS

CNC-WORKED FLUID
RESERVOIR

FULL CLUTCH

HYDRAULIC-CLUTCH
TRANSFORMATION KIT

LEVER

THROTTLE CONTROL

BRAKE CALIPER

RACING KIT

BUTTON PANEL

LEVER GUARD

CLIP-ON

STREET RACING
REARSET

FUEL CAPS

STEERING NUT

CRASH PADS

Paddock STAND

MIRROR COVERS

REAR-VIEW MIRRORS

FOG LIGHTS KIT

HANDLEBARS
ACCESSORIES

HANDLEBARS



BRAKE/CLUTCH
MASTER CYLINDERS

ACCESSORIES
SPARE PARTS

CNC-WORKED FLUID
RESERVOIR

FULL CLUTCH

HYDRAULIC-CLUTCH
TRANSFORMATION KIT

LEVER

THROTTLE CONTROL

BRAKE CALIPER

RACING KIT

BUTTON PANEL

LEVER GUARD

CLIP-ON

STREET RACING
REARSET

FUEL CAPS

STEERING NUT

CRASH PADS

Paddock STAND

MIRROR COVERS

REAR-VIEW MIRRORS

FOG LIGHTS KIT

HANDLEBARS
ACCESSORIES

HANDLEBARS



BRAKE/CLUTCH
MASTER CYLINDERS

ACCESSORIES
SPARE PARTS

CNC-WORKED FLUID
RESERVOIR

FULL CLUTCH

HYDRAULIC-CLUTCH
TRANFORMATION KIT

LEVER

THROTTLE CONTROL

BRAKE CALIPER

RACING KIT

BUTTON PANEL

LEVER GUARD

CLIP-ON

STREET RACING
REARSET

FUEL CAPS

STEERING NUT

CRASH PADS

PADDOCK STAND

MIRROR COVERS

REAR-VIEW MIRRORS

FOG LIGHTS KIT

HANDLEBARS
ACCESSORIES

HANDLEBARS



BRAKE/CLUTCH
MASTER CYLINDERS

ACCESSORIES
SPARE PARTS

CNC-WORKED FLUID
RESERVOIR

FULL CLUTCH

HYDRAULIC-CLUTCH
TRANSFORMATION KIT

LEVER

THROTTLE CONTROL

BRAKE CALIPER

RACING KIT

BUTTON PANEL

LEVER GUARD

CLIP-ON

STREET RACING
REARSET

FUEL CAPS

STEERING NUT

CRASH PADS

Paddock STAND

MIRROR COVERS

REAR-VIEW MIRRORS

FOG LIGHTS KIT

HANDLEBARS
ACCESSORIES

HANDLEBARS



BRAKE/CLUTCH
MASTER CYLINDERS

ACCESSORIES
SPARE PARTS

CNC-WORKED FLUID
RESERVOIR

FULL CLUTCH

HYDRAULIC-CLUTCH
TRANFORMATION KIT

LEVER

THROTTLE CONTROL

BRAKE CALIPER

RACING KIT

BUTTON PANEL

LEVER GUARD

CLIP-ON

STREET RACING
REARSET

FUEL CAPS

STEERING NUT

CRASH PADS

Paddock STAND

MIRROR COVERS

REAR-VIEW MIRRORS

FOG LIGHTS KIT

HANDLEBARS
ACCESSORIES

HANDLEBARS



BRAKE/CLUTCH
MASTER CYLINDERS

ACCESSORIES
SPARE PARTS

CNC-WORKED FLUID
RESERVOIR

FULL CLUTCH

HYDRAULIC-CLUTCH
TRANSFORMATION KIT

LEVER

THROTTLE CONTROL

BRAKE CALIPER

RACING KIT

BUTTON PANEL

LEVER GUARD

CLIP-ON

STREET RACING
REARSET

FUEL CAPS

STEERING NUT

CRASH PADS

PADOCK STAND

MIRROR COVERS

REAR-VIEW MIRRORS

FOG LIGHTS KIT

HANDLEBARS
ACCESSORIES

HANDLEBARS



BRAKE/CLUTCH
MASTER CYLINDERS

ACCESSORIES
SPARE PARTS

CNC-WORKED FLUID
RESERVOIR

FULL CLUTCH

HYDRAULIC-CLUTCH
TRANFORMATION KIT

LEVER

THROTTLE CONTROL

BRAKE CALIPER

RACING KIT

BUTTON PANEL

LEVER GUARD

CLIP-ON

STREET RACING
REARSET

FUEL CAPS

STEERING NUT

CRASH PADS

PADDOCK STAND

MIRROR COVERS

REAR-VIEW MIRRORS

FOG LIGHTS KIT

HANDLEBARS
ACCESSORIES

HANDLEBARS



BRAKE/CLUTCH
MASTER CYLINDERS

ACCESSORIES
SPARE PARTS

CNC-WORKED FLUID
RESERVOIR

FULL CLUTCH

HYDRAULIC-CLUTCH
TRANFORMATION KIT

LEVER

THROTTLE CONTROL

BRAKE CALIPER

RACING KIT

BUTTON PANEL

LEVER GUARD

CLIP-ON

STREET RACING
REARSET

FUEL CAPS

STEERING NUT

CRASH PADS

Paddock STAND

MIRROR COVERS

REAR-VIEW MIRRORS

FOG LIGHTS KIT

HANDLEBARS
ACCESSORIES

HANDLEBARS



- BRAKE/CLUTCH MASTER CYLINDERS
- ACCESSORIES SPARE PARTS
- CNC-WORKED FLUID RESERVOIR
- FULL CLUTCH
- HYDRAULIC-CLUTCH TRANFORMATION KIT
- LEVER
- THROTTLE CONTROL
- BRAKE CALIPER
- RACING KIT
- BUTTON PANEL
- LEVER GUARD
- CLIP-ON
- STREET RACING REARSET
- FUEL CAPS
- STEERING NUT
- CRASH PADS
- PADDOCK STAND
- MIRROR COVERS
- REAR-VIEW MIRRORS
- FOG LIGHTS KIT
- HANDLEBARS ACCESSORIES
- HANDLEBARS



BRAKE/CLUTCH
MASTER CYLINDERS

ACCESSORIES
SPARE PARTS

CNC-WORKED FLUID
RESERVOIR

FULL CLUTCH

HYDRAULIC-CLUTCH
TRANFORMATION KIT

LEVER

THROTTLE CONTROL

BRAKE CALIPER

RACING KIT

BUTTON PANEL

LEVER GUARD

CLIP-ON

STREET RACING
REARSET

FUEL CAPS

STEERING NUT

CRASH PADS

Paddock STAND

MIRROR COVERS

REAR-VIEW MIRRORS

FOG LIGHTS KIT

HANDLEBARS
ACCESSORIES

HANDLEBARS



BRAKE/CLUTCH
MASTER CYLINDERS

ACCESSORIES
SPARE PARTS

CNC-WORKED FLUID
RESERVOIR

FULL CLUTCH

HYDRAULIC-CLUTCH
TRANFORMATION KIT

LEVER

THROTTLE CONTROL

BRAKE CALIPER

RACING KIT

BUTTON PANEL

LEVER GUARD

CLIP-ON

STREET RACING
REARSET

FUEL CAPS

STEERING NUT

CRASH PADS

PADDOCK STAND

MIRROR COVERS

REAR-VIEW MIRRORS

FOG LIGHTS KIT

HANDLEBARS
ACCESSORIES

HANDLEBARS

BRAKE/CLUTCH
MASTER CYLINDERS

ACCESSORIES
SPARE PARTS

CNC-WORKED FLUID
RESERVOIR

FULL CLUTCH

HYDRAULIC-CLUTCH
TRANFORMATION KIT

LEVER

THROTTLE CONTROL

BRAKE CALIPER

RACING KIT

BUTTON PANEL

LEVER GUARD

CLIP-ON

STREET RACING
REARSET

FUEL CAPS

STEERING NUT

CRASH PADS

Paddock STAND

MIRROR COVERS

REAR-VIEW MIRRORS

FOG LIGHTS KIT

HANDLEBARS
ACCESSORIES

HANDLEBARS

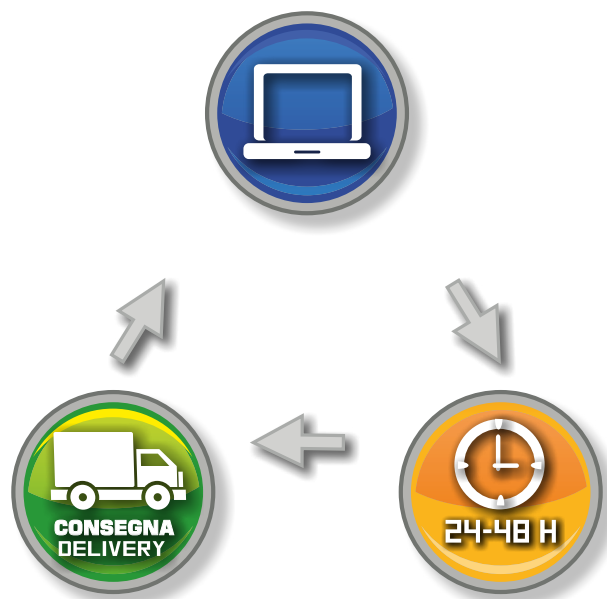

www.accossato.com
registrati e ordina sul **B2B Accossato**
register & order on the **Accossato B2B**

Avvertente / Warning

Prodotti da utilizzare in circuito chiuso

Tutti i prodotti di questo catalogo sono per uso agonistico e utilizzabili in circuito chiuso. il loro utilizzo su strade aperte al pubblico è vietato. il montaggio del prodotto deve essere effettuato da officine o rivenditori autorizzati accossato.

Esclusione di responsabilità

Accossato Racing oppure i suoi rivenditori saranno lieti di assistere i clienti nella scelta della fornitura esatta degli accessori di montaggio eventualmente necessari o delle varianti tra le parti adatte per la propria moto.

Accossato Racing si riserva il diritto, senza preavviso e senza fornirne i motivi, di modificare specifiche tecniche, colori, materiali, di cancellarli senza sostituirli o di interrompere la produzione di determinati prodotti. Tutti i dati sono forniti senza impegno fatti salvi i refusi, errori di stampa, di composizione e omissioni. Accossato Racing si riserva il diritto di apportare, in qualsiasi momento, le modifiche del caso. Accossato Racing declina qualsiasi responsabilità da problematiche intercorse di qualsiasi tipo in seguito all'acquisto di componenti sciolti tubi freno e successiva realizzazione del kit presso il Cliente.

Avvertenza

Non imitare! I motociclisti qui ritratti sono piloti professionisti. le fotografie sono state realizzate in circuiti chiusi o su strade chiuse al traffico. Accossato Racing invita tutti i motociclisti ad indossare l'abbigliamento prescritto e a guidare con coscienza nel rispetto delle relative disposizioni applicabili del codice della strada.

Alcuni articoli della gamma accossato racing possono non essere omologati per l'uso su strada (a seconda del paese). Per maggiori informazioni rivolgersi agli uffici commerciali accossato racing.

Products reserved for closed tracks

The products on this catalogue are intended for exclusive racing use and must be used on closed tracks. Their usage on public highways and roads is strictly forbidden. the assembling of the spare parts must be done by accossato authorized distributors and shops.

Exclusion of liability

Accossato racing or its distributors will be glad to help the customers choosing the exact and/or necessary spare parts for their own motorcycle. accossato racing reserves the right to modify/cancel without replacement technical specifications, colors, materials or to stop the production of some kind of products. The company will provide all the details with no obligation omissions, errors, misprints excepted. In any moment accossato racing reserves the right to modify any section of this catalogue. Accossato Racing declines any responsibility from issues occurred after purchasing loose parts brake hoses and the following realization of the kit by the Client.

Warning

Don't imitate! The racers in the pictures are professional racers. the pictures were be shoted in closed tracks.

Accossato racing invites all the racers to wear the correct clothing and to drive coscientiously in respect of the traffic laws.

Some products of accossato's selection can't be homologate to be used on the public highways (based on the rules of the different countries). For further information please contact Accossato Racing sales department.

BRAKE/CLUTCH
MASTER CYLINDERS

ACCESSORIES
SPARE PARTS

CNC-WORKED FLUID
RESERVOIR

FULL CLUTCH

HYDRAULIC-CLUTCH
TRANSFORMATION KIT

LEVER

THROTTLE CONTROL

BRAKE CALIPER

RACING KIT

BUTTON PANEL

LEVER GUARD

CLIP-ON

STREET RACING
REARSET

FUEL CAPS

STEERING NUT

CRASH PADS

PADOCK STAND

MIRROR COVERS

REAR-VIEW MIRRORS

FOG LIGHTS KIT

HANDLEBARS
ACCESSORIES

HANDLEBARS

BRAKE/CLUTCH
MASTER CYLINDERS

ACCESSORIES
SPARE PARTS

CNC-WORKED FLUID
RESERVOIR

FULL CLUTCH

HYDRAULIC-CLUTCH
TRANFORMATION KIT

LEVER

THROTTLE CONTROL

BRAKE CALIPER

RACING KIT

BUTTON PANEL

LEVER GUARD

CLIP-ON

STREET RACING
REARSET

FUEL CAPS

STEERING NUT

CRASH PADS

Paddock STAND

MIRROR COVERS

REAR-VIEW MIRRORS

FOG LIGHTS KIT

HANDLEBARS
ACCESSORIES

HANDLEBARS

INDICE CATALOGO

1. Pompe freno /brake master cylinders	
• Pompe freno ø 19/ brake master cylinders ø 19	(1-5)
• Pompe freno ø 17/ brake master cylinders ø 17	(6-7)
• Pompe freno ø 16/ brake master cylinders ø 16	(8-11)
• Pompe freno ø 15/ brake master cylinders ø 15	(12-12)
• Pompe freno ø 14/ brake master cylinders ø 14	(13-13)
• Pompe freno ø 10/ brake master cylinders ø 10	(14-14)
2. Pompe frizione / clutch master cylinders	
• Pompe frizione ø 19/ clutch master cylinders ø 19	(15-16)
• Pompe frizione ø 17/ clutch master cylinders ø 17	(17-17)
• Pompe frizione ø 16/ clutch master cylinders ø 16.....	(18-20)
• Pompe frizione ø 15/ clutch master cylinders ø 15	(21-21)
• Pompe frizione ø 14/ clutch master cylinders ø 14	(22-22)
3. Pompe freno posteriore / rear brake master cylinder	
• Pompe freno a pollice / thumb master cylinder	(23-24)
• Pompe freno posteriore hrnc / hand rear brake master cylinder	(25-26)
• Pompe freno posteriore / rear brake master cylinder.....	(27-29)
4. Fluido freni / brake fluid	(30-32)
5. Accessori / accessories - ricambi / spare parts	(33-35)
6. Polsino protezione olio / accossato design oil tank protection	(36)
7. Serbatoio olio cnc-freno / cnc-worked fluid reservoir – brake.....	(37-38)
8. Vaschette olio cnc freno/frizione / brake & clutch cnc-worked fluid reservoirs	(39)
9. Vaschette olio trasparenti freno/frizione / brake & clutch transparent fluid reservoirs	(40)
10. Comando frizione a cavo / full clutch	
• comando frizione a cavo / full clutch	(41)
• comando frizione a cavo "revolution" / "revolution" full clutch.....	(42)
• comando frizione a cavo "racing" / "racing" full clutch	(43)
• comando frizione a cavo off road / off road full clutch	(44)
• comando frizione a cavo Moto 3 / Moto 3 full clutch	(45)
11. Kit di trasformazione frizione filo-idraulica / hydraulic-clutch transformation kit	(46)
12. Leve snodate: ricambio per comandi frizione / folding levers: spare parts for full clutches	(47-48)
13. Leva snodata con impugnatura "revolution" / folding lever with "revolution" handle.....	(49)
14. Leve fisse: ricambio per pompe freno/frizione fix levers / spare parts for brake/clutch master cylinders	(50)
15. Leva snodata per pompa "Ready to brake" / folding levers: spare parts for "Ready to brake" master cylinder.....	(51)
16. Leva snodata con impugnatura "revolution" / folding lever with "revolution" handle	(52)
17. Leve snodate: ricambio per pompe freno/frizione / folding levers: spare parts for brake/clutch master cylinders	(53)
18. Leve di ricambio pompe freno/frizione / oem levers: spare parts for brake/clutch master cylinders.....	(54-57)
19. Leve fisse cnc freno - frizione / brake & clutch cnc-worked levers	(58-62)
20. Leve a controllo remoto integrato / brake lever with integrated remote adjuster	(63-67)
21. Leve motorizzate /mechanized levers	(68-69)

BRAKE/CLUTCH
MASTER CYLINDERS

ACCESSORIES
SPARE PARTS

CNC-WORKED FLUID
RESERVOIR

FULL CLUTCH

HYDRAULIC-CLUTCH
TRANSFORMATION KIT

LEVER

THROTTLE CONTROL

BRAKE CALIPER

RACING KIT

BUTTON PANEL

LEVER GUARD

CLIP-ON

STREET RACING
REARSET

FUEL CAPS

STEERING NUT

CRASH PADS

PADDOCK STAND

MIRROR COVERS

REAR-VIEW MIRRORS

FOG LIGHTS KIT

HANDLEBARS
ACCESSORIES

HANDLEBARS

22. Comandi gas / throttle control	(70-76)
23. Manopole racing / racing grips	(77-81)
24. Sgancio rapido comando gas / gas control quick disconnect	(82-83)
25. Sensori del cambio / quick shifter sensor	(84-85)
26. Pinze freno	
• Interasse / distance 108	(86-90)
• Interasse / distance 100	(91-93)
• Interasse / distance 60	(94-96)
• Application list	(97-100)
27. Distanziali per pinze freno radiali anteriori /front radial caliper spacers	(101-103)
28. Kit flange freno /brake-flanges kit	(104)
29. Kit racing	(105-106)
30. Sgancio rapido tubo freno / brake-hose quick disconnect	(107)
31. Pulsantiere / button panel	(108-112)
32. Paraleva "deflector" / lever guard	(113-114)
33. Semi manubri / clip on	(115-128)
34. Manopole racing alluminio cnc / aluminum cnc-worked racing grips	(129-133)
35. Manopole riscaldate / warmed-up grips	(134)
36. Pedane street racing / street racing rearsets	(135-137)
37. Pedane touring / touring rearsets	(138-139)
38. Tappi sebatoio / fuel-caps	(140-144)
39. Tappo per vaschette / fluid reservoir cap	(145-158)
40. Tappi olio / oil filler cap	(159-166)
41. Ghiera di sterzo / steering nut.....	(167-168)
42. Ghiera precarico forcella fork preload steering nut.....	(169-171)
43. Tamponi paracarena / crash pads	(172-175)
44. Protezione corona / sprocket defender	(176)
45. Protezione forcella / fork protection	(177-179)
46. Cavalletto smontabile / disassembled stand.....	(180-183)
47. Supporti cavalletto / stand support	(184-187)
48. Tappi specchietti / mirror covers	(188-189)
49. Specchietti retrovisori / rear-view mirrors	(190- 204)
50. Kit proiettori fendinebbia e supporti / led fog lights kit	(205)
51. Catadiottro / retroreflector	(206)
52. Contrappesi / handlebar ends	(207-210)
53. Cavallotti / risers	(211-212)
54. Manubri /handlebars	(213-244)



BRAKE/CLUTCH
MASTER CYLINDERS

ACCESSORIES
SPARE PARTS

CNC-WORKED FLUID
RESERVOIR

FULL CLUTCH

HYDRAULIC-CLUTCH
TRANSFORMATION KIT

LEVER

THROTTLE CONTROL

BRAKE CALIPER

RACING KIT

BUTTON PANEL

LEVER GUARD

CLIP-ON

STREET RACING
REARSET

FUEL CAPS

STEERING NUT

CRASH PADS

Paddock STAND

MIRROR COVERS

REAR-VIEW MIRRORS

FOG LIGHTS KIT

HANDLEBARS
ACCESSORIES

HANDLEBARS

BRAKE/CLUTCH
MASTER CYLINDERS

ACCESSORIES
SPARE PARTS

CNC-WORKED FLUID
RESERVOIR

FULL CLUTCH

HYDRAULIC-CLUTCH
TRANFORMATION KIT

LEVER

THROTTLE CONTROL

BRAKE CALIPER

RACING KIT

BUTTON PANEL

LEVER GUARD

CLIP-ON

STREET RACING
REARSET

FUEL CAPS

STEERING NUT

CRASH PADS

PADDOCK STAND

MIRROR COVERS

REAR-VIEW MIRRORS

FOG LIGHTS KIT

HANDLEBARS
ACCESSORIES

HANDLEBARS

ACCOSSATO®

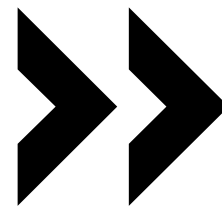

Lifestyle

BRAKE/CLUTCH
MASTER CYLINDERS

ACCESSORIES
SPARE PARTS

CNC-WORKED FLUID
RESERVOIR

FULL CLUTCH

HYDRAULIC-CLUTCH
TRANFORMATION KIT

LEVER

THROTTLE CONTROL

BRAKE CALIPER

RACING KIT

BUTTON PANEL

LEVER GUARD

CLIP-ON

STREET RACING
REARSET

FUEL CAPS

STEERING NUT

CRASH PADS

Paddock STAND

MIRROR COVERS

REAR-VIEW MIRRORS

FOG LIGHTS KIT

HANDLEBARS
ACCESSORIES

HANDLEBARS

BRAKE/CLUTCH
MASTER CYLINDERS

ACCESSORIES
SPARE PARTS

CNC-WORKED FLUID
RESERVOIR

FULL CLUTCH

HYDRAULIC-CLUTCH
TRANFORMATION KIT

LEVER

THROTTLE CONTROL

BRAKE CALIPER

RACING KIT

BUTTON PANEL

LEVER GUARD

CLIP-ON

STREET RACING
REARSET

FUEL CAPS

STEERING NUT

CRASH PADS

Paddock STAND

MIRROR COVERS

REAR-VIEW MIRRORS

FOG LIGHTS KIT

HANDLEBARS
ACCESSORIES

HANDLEBARS

POMPE FRENO Ø 19

BRAKE MASTER CYLINDERS Ø 19



■ Pompa freno Ø 19 CNC / CNC Brake Master Cylinders Ø 19

Codice Reference	Descrizione Description
CY001	Pompa freno radiale 19x18 CNC / CNC-worked brake master cylinder 19x18
CY002	Pompa freno radiale 19x19 CNC / CNC-worked brake master cylinder 19x19
CY003	Pompa freno radiale 19x20 CNC / CNC-worked brake master cylinder 19x20
CY004	Pompa freno PRS 19x17-18-19 CNC / CNC-worked PRS brake master cylinder 19x17-18-19

■ Colori / Colours

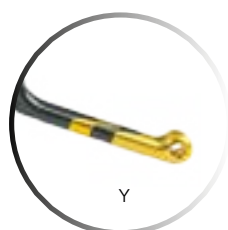

Y
Oro / Gold

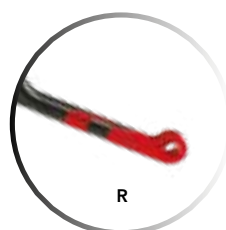

R
Rosso / Red



S
Argento / Silver

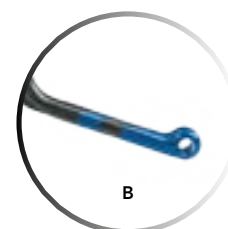

B
Blu / Blue

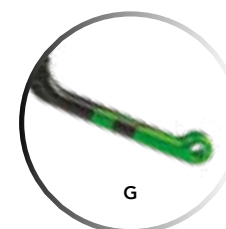

G
Verde / Green

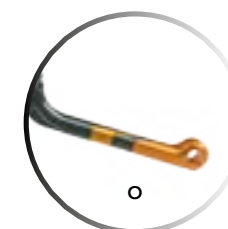

O
Arancione / Orange

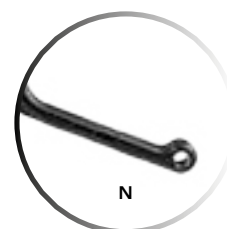

N
Nero / Black

- BRAKE/CLUTCH MASTER CYLINDERS
- ACCESSORIES SPARE PARTS
- CNC-WORKED FLUID RESERVOIR
- FULL CLUTCH
- HYDRAULIC-CLUTCH TRANSFORMATION KIT
- LEVER
- THROTTLE CONTROL
- BRAKE CALIPER
- RACING KIT
- BUTTON PANEL
- LEVER GUARD
- CLIP-ON
- STREET RACING REARSET
- FUEL CAPS
- STEERING NUT
- CRASH PADS
- Paddock STAND
- MIRROR COVERS
- REAR-VIEW MIRRORS
- FOG LIGHTS KIT
- HANDLEBARS ACCESSORIES
- HANDLEBARS

■ Pompe freno Ø 19 forgiate / Forged Brake Master Cylinders Ø 19

Codice/Reference		Descrizione Description
Corpo nero Black body	Corpo naturale Natural body	
CL023	CY023	Pompa freno 19x18 forgiata, con leva fissa Forged brake master cylinder 19x18, with fix lever
CL021	CY021	Pompa freno 19x18 forgiata, con leva snodata Forged brake master cylinder 19x18, with folding lever
CL039	CY039	Pompa freno 19x19 forgiata, con leva fissa Forged brake master cylinder 19x19, with fix lever
CL040	CY040	Pompa freno 19x19 forgiata, con leva snodata Forged brake master cylinder 19x19, with folding lever
CL029	CY029	Pompa freno 19x20 forgiata, con leva fissa Forged brake master cylinder 19x20, with fix lever
CL035	CY035	Pompa freno 19x20 forgiata, con leva snodata Forged brake master cylinder 19x20, with folding lever
	CY041	Pompa freno 19x21 forgiata, con leva snodata Forged brake master cylinder 19x21, with folding lever
CL022	CY022	Pompa freno PRS 19x17-18-19 forgiata, con leva snodata PRS forged brake master cylinder 19x17-18-19, with folding lever



Opzioni leva /Lever options

Lunga Long	17cm
Corta Short	15cm
Con RST With RST	

Colori leve / Lever Colours

Corpo nero Black body Serie CL	N ● nero - black	O ● arancione - orange	Y ● oro - gold	B ● blu - blue	R ● rosso - red	S ● argento - silver	G ● verde - green
Corpo naturale Natural body Serie CY	N ● nero - black						

Nota: Solo nella versione black edition la leva è colorata
Note: Only in the black edition version the lever is colored

BRAKE/CLUTCH
MASTER CYLINDERS
 ACCESSORIES
SPARE PARTS
 CNC-WORKED FLUID
RESERVOIR
 FULL CLUTCH
 HYDRAULIC-CLUTCH
TRANFORMATION KIT
 LEVER
 THROTTLE CONTROL
 BRAKE CALIPER
 RACING KIT
 BUTTON PANEL
 LEVER GUARD
 CLIP-ON
 STREET RACING
REARSET
 FUEL CAPS
 STEERING NUT
 CRASH PADS
 PADDOCK STAND
 MIRROR COVERS
 REAR-VIEW MIRRORS
 FOG LIGHTS KIT
 HANDLEBARS
ACCESSORIES
 HANDLEBARS

■ Pompe freno Ø 19 "Revolution" / "Revolution" brake master cylinders Ø 19

Codice Reference	Descrizione Description
CL053	Pompa freno radiale forgiata 19x18 con leva revolution e corpo nero <i>Forged radial brake master cylinder 19x18 with revolution lever and black body</i>
CL054	Pompa freno radiale forgiata 19x19 con leva revolution e corpo nero <i>Forged radial brake master cylinder 19x19 with revolution lever and black body</i>
CL057	Pompa freno radiale forgiata 19x20 con leva revolution e corpo nero <i>Forged radial brake master cylinder 19x20 with revolution lever and black body</i>
CL050	Pompa freno radiale forgiata PRS 19x17-18-19 con leva revolution e corpo nero <i>PRS forged radial brake master cylinder 19x17-18-19 with revolution lever and black body</i>



Colori inserti e codino / Insert and ending colours

N ●	O ●	Y ●	B ●	R ●	S ●	G ●
nero - black	arancione - orange	oro - gold	blu - blue	rosso - red	argento - silver	verde - green

Nota: Secondo inserto solo in nero / second insert in black color only
 Note: Perno di regolazione e codino: stesso colore / adjusting knob & ending: same color

■ Pompe freno Ø 19 "Glow Blow" / "Glow Blow" brake master cylinders Ø 19

Codice Reference	Descrizione Description
CY042	Pompa freno radiale 19x18, con corpo pompa verniciato + leva "revolution" nera <i>Radial brake m. cly. 19x18, with coated body & black "revolution" lever</i>
CY043	Pompa freno radiale 19x20, con corpo pompa verniciato + leva "revolution" nera <i>Radial brake m. cly. 19x20, with coated body & black "revolution" lever</i>



Colori corpo pompa / Master cylinder body colours

N ●	Y ●	B ●	R ●	G ●	S ●
nero - black	giallo fluo fluorescent yellow	blu - blue	rosso - red	verde - green	argento - silver

BRAKE/CLUTCH
 MASTER CYLINDERS
 ACCESSORIES
 SPARE PARTS
 CNC-WORKED FLUID
 RESERVOIR
 FULL CLUTCH
 HYDRAULIC-CLUTCH
 TRANSFORMATION KIT
 LEVER
 THROTTLE CONTROL
 BRAKE CALIPER
 RACING KIT
 BUTTON PANEL
 LEVER GUARD
 CLIP-ON
 STREET RACING
 REARSET
 FUEL CAPS
 STEERING NUT
 CRASH PADS
 PADDOCK STAND
 MIRROR COVERS
 REAR-VIEW MIRRORS
 FOG LIGHTS KIT
 HANDLEBARS
 ACCESSORIES
 HANDLEBARS

■ Pompe freno Ø 19 con vaschetta integrata / "With integrated fluid reservoir" Brake master cylinders Ø 19

Codice Reference	Descrizione Description
PK023	Pompa freno 19x18 forgiata, con vaschetta integrata, con leva fissa <i>Forged brake master cylinder 19x18, with integrated fluid reservoir & fix lever</i>
PK021	Pompa freno 19x18 forgiata, con vaschetta integrata, con leva snodata <i>Forged brake master cylinder 19x18, with integrated fluid reservoir & folding lever</i>
PK039	Pompa freno 19x19 forgiata, con vaschetta integrata, con leva fissa <i>Forged brake master cylinder 19x19, with integrated fluid reservoir & fix lever</i>
PK040	Pompa freno 19x19 forgiata, con vaschetta integrata, con leva snodata <i>Forged brake master cylinder 19x19, with integrated fluid reservoir & folding lever</i>
PK029	Pompa freno 19x20 forgiata, con vaschetta integrata, con leva fissa <i>Forged brake master cylinder 19x20, with integrated fluid reservoir & fix lever</i>
PK035	Pompa freno 19x20 forgiata, con vaschetta integrata, con leva snodata <i>Forged brake master cylinder 19x20, with integrated fluid reservoir & folding lever</i>
PK022	Pompa freno PRS 19x17-18-19 forgiata, con vaschetta integrata, con leva snodata <i>PRS Forged brake master cylinder 19x17-18-19, with integrated fluid reservoir & folding lever</i>



Colori leve e vaschetta / Levers colours and reservoir



■ Pompa freno Ø 19 "Ready to brake" CNC / "Ready to brake" CNC Brake Master Cylinders Ø 19

Codice Reference	Descrizione Description
CY087	Pompa freno CNC 19x18 con leva snodata <i>CNC brake master cylinder 19x18 with folding lever</i>
CY088	Pompa freno CNC 19x19 con leva snodata <i>CNC brake master cylinder 19x19 with folding lever</i>
CY089	Pompa freno CNC 19x20 con leva snodata <i>CNC brake master cylinder 19x20 with folding lever</i>
CY090	Pompa freno CNC PRS 19x17-18-19 con leva snodata <i>PRS CNC brake master cylinder 19x17-18-19 with folding lever</i>

Opzioni leva /Lever options

Lunga / Long	17cm	Con RST / With RST
Corta / Short	15cm	Con RST / With RST

A = Microinterruttore incluso / Included Switch • B = Shark design
C = Braccialeto sgancio rapido / Quick disconnecter hose clamp

Nota: Fino ad esaurimento scorte sarà disponibile la versione forgiata
Note: While stocks last, the forged version will be available

Colori impugnatura / Handle colours

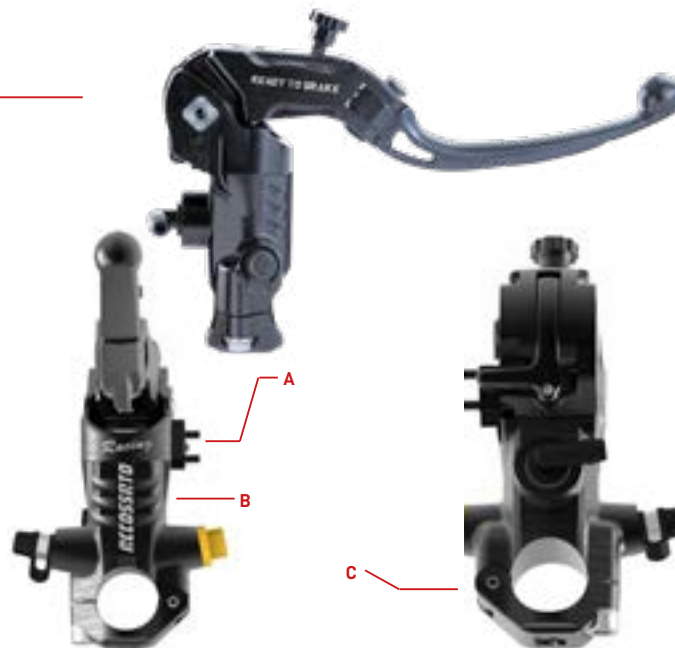
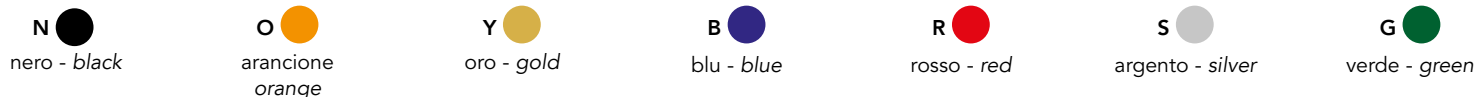

BRAKE/CLUTCH
 MASTER CYLINDERS
 ACCESSORIES
 SPARE PARTS
 CNC-WORKED FLUID
 RESERVOIR
 FULL CLUTCH
 HYDRAULIC-CLUTCH
 TRANSFORMATION KIT
 LEVER
 THROTTLE CONTROL
 BRAKE CALIPER
 RACING KIT
 BUTTON PANEL
 LEVER GUARD
 CLIP-ON
 STREET RACING
 REARSET
 FUEL CAPS
 STEERING NUT
 CRASH PADS
 PADDOCK STAND
 MIRROR COVERS
 REAR-VIEW MIRRORS
 FOG LIGHTS KIT
 HANDLEBARS
 ACCESSORIES
 HANDLEBARS

■ Pompa freno CNC "GA" Ø 19 / "GA" Brake Master Cylinders Ø 19

Codice Reference	Descrizione Description
GA001	Pompa freno PRS 19x17-18-19 CNC CNC-worked PRS brake master cylinder 19x17-18-19

Descrizione Description

Appena terminata, dopo tanti anni di sviluppo, è destinata a rivoluzionare il concetto di frenata nelle pompe radiali racing

Just disegned, this new born of Accossato is bound to change forever the concept of brake in racing radial master cylinders

Caratteristiche tecniche Technical Specs

- Pompa radiale con pressione in contropinta / Radial master Cylinder working in counterthrust
- Esclusivo brevetto Accossato / Accossato exclusive patent
- Idraulica innovativa / Innovative hydraulics
- Aumento potenza frenante / Increased braking power
- Elevata modulabilità / High modular control
- Feeling Corsa a vuoto leva pressochè a zero / Spare travel feeling around zero
- Rilascio pressione su pastiglie fino a 10 volte più rapido rispetto a una pompa tradizionale / Pressure release on brake pads up to 10 times quicker than traditional master cylinders
- Autospurgante / self-bleed system
- Auto ricarica del fluido dei freni / Brake fluid self-refill

■ Pompe freno Ø 19 "Custom" attacco 1 pollice (25,4 mm) / "Custom" Brake master cylinders Ø 19 - 1 inch (25,4 mm)

Codice/Reference		Descrizione Description
Corpo nero Black body	Corpo naturale Natural body	
PC010	PC003	Pompa freno radiale 19x18, forgiata, con leva fissa / Forged brake master cylinder 19x18 with fixed lever
PC009	PC002	Pompa freno radiale 19x18, forgiata, con leva snodata / Forged brake master cylinder 19x18 with folding lever
PC012	PC005	Pompa freno radiale 19x19, forgiata, con leva fissa / Forged brake master cylinder 19x19 with fixed lever
PC011	PC004	Pompa freno radiale 19x19, forgiata, con leva snodata / Forged brake master cylinder 19x19 with folding lever
PC013	PC006	Pompa freno radiale 19x20, forgiata, con leva fissa / Forged brake master cylinder 19x20 with fixed lever
PC014	PC007	Pompa freno radiale 19x20, forgiata, con leva snodata / Forged brake master cylinder 19x20 with folding lever
PC008	PC001	Pompa freno PRS 19x17-18-19, forgiata, con leva snodata / PRS forged brake master cylinder 19x17-18-19 with folding lever

Opzioni leva Lever options

Lunga /long: 17 cm	Corta /short: 15 cm	Con RST with RST
-----------------------	------------------------	---------------------

Colori leve / Lever Colours

Corpo nero
Black body
Serie CL

N 	O 	Y 	B 	R 	S 	G 
nero - black	arancione - orange	oro - gold	blu - blue	rosso - red	argento - silver	verde - green

Corpo naturale
Natural body
Serie CY

N 

nero - black

Nota: Solo nella versione black edition la leva è colorata
Note: Only in the black edition version the lever is colored



BRAKE/CLUTCH
MASTER CYLINDERS
 ACCESSORIES
SPARE PARTS
 CNC-WORKED FLUID
RESERVOIR
 FULL CLUTCH
 HYDRAULIC-CLUTCH
TRANFORMATION KIT
 LEVER
 THROTTLE CONTROL
 BRAKE CALIPER
 RACING KIT
 BUTTON PANEL
 LEVER GUARD
 CLIP-ON
 STREET RACING
REARSET
 FUEL CAPS
 STEERING NUT
 CRASH PADS
 PADDOCK STAND
 MIRROR COVERS
 REAR-VIEW MIRRORS
 FOG LIGHTS KIT
 HANDLEBARS
ACCESSORIES
 HANDLEBARS

POMPE FRENO Ø 17

BRAKE MASTER CYLINDERS Ø 17

■ Pompe freno Ø 17 forgiate / Forged Brake Master Cylinders Ø 17
(moto con pinze uguali o inferiori a 32 mm / Motorcycle with brake calipers equal to or less than 32 mm)

Codice/Reference		Descrizione Description
Corpo nero Black body	Corpo naturale Natural body	
CL074	CY074	Pompa freno forgiata 17x18 leva fissa Forged brake master cylinder 17x18 fix lever
CL075	CY075	Pompa freno forgiata 17x18 leva snodata Forged brake master cylinder 17x18 folding lever
CL076	CY076	Pompa freno forgiata 17x19 leva fissa Forged brake master cylinder 17x19 fix lever
CL077	CY077	Pompa freno forgiata 17x19 leva snodata Forged brake master cylinder 17x19 folding lever
CL078	CY078	Pompa freno forgiata 17x20 leva fissa Forged brake master cylinder 17x20 fix lever
CL079	CY079	Pompa freno forgiata 17x20 leva snodata Forged brake master cylinder 17x20 folding lever
CL080	CY080	Pompa freno forgiata PRS 17x17-18-19 leva snodata PRS Forged brake master cylinder 17x17-18-19 folding lever



Opzioni leva /Lever options

Lunga Long	17cm
Corta Short	15cm
Con RST With RST	

Colori leva / Lever Colours

Corpo nero
Black body
Serie CL

N ●
nero - black

O ●
arancione - orange

Y ●
oro - gold

B ●
blu - blue

R ●
rosso - red

S ●
argento - silver

G ●
verde - green

Corpo naturale
Natural body
Serie CY

N ●
nero - black

Nota: Solo nella versione black edition la leva è colorata
Note: Only in the black edition version the lever is colored

■ Pompa freno CNC Ø 17 "Ready to brake" / "Ready to brake" Brake Master Cylinders Ø 17

Codice Reference	Descrizione Description
CY107	Pompa freno CNC 17x18 con leva snodata CNC brake master cylinder 17x16 with folding lever
CY108	Pompa freno CNC 17x20 con leva snodata CNC brake master cylinder 17x18 with folding lever
CY109	Pompa freno CNC PRS 17x17-18-19 con leva snodata PRS CNC brake master cylinder 17x17-18-19 with folding lever

Opzioni leva /Lever options

Lunga / Long	17cm	Con RST / With RST
Corta / Short	15cm	Con RST / With RST

A = Microinterruttore incluso / Included Switch • B = Shark design
C = Bracciale sgancio rapido / Quick disconnecter hose clamp

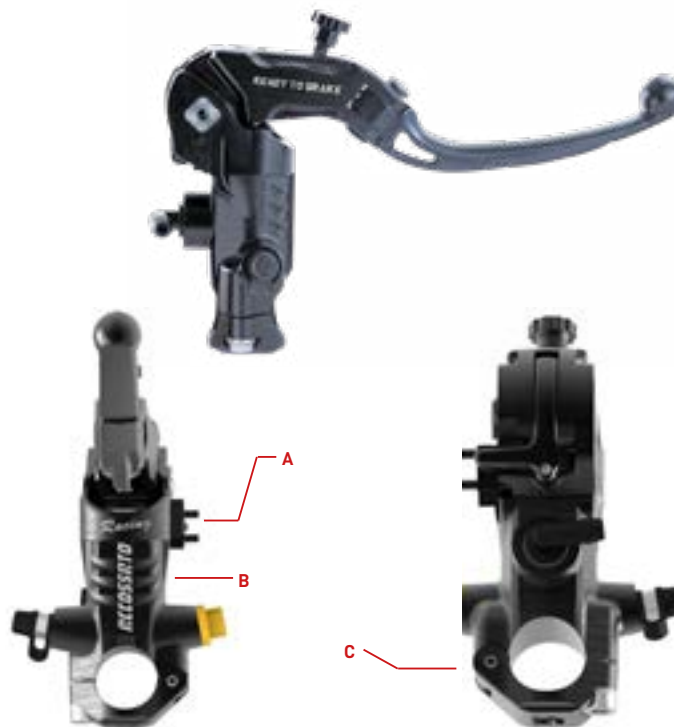

Colori impugnatura / Handle colours

N ● nero - black	O ● arancione orange	Y ● oro - gold	B ● blu - blue	R ● rosso - red	S ● argento - silver	G ● verde - green
---------------------	----------------------------	-------------------	-------------------	--------------------	-------------------------	----------------------

BRAKE/CLUTCH
 MASTER CYLINDERS
 ACCESSORIES
 SPARE PARTS
 CNC-WORKED FLUID
 RESERVOIR
 FULL CLUTCH
 HYDRAULIC-CLUTCH
 TRANSFORMATION KIT
 LEVER
 THROTTLE CONTROL
 BRAKE CALIPER
 RACING KIT
 BUTTON PANEL
 LEVER GUARD
 CLIP-ON
 STREET RACING
 REARSET
 FUEL CAPS
 STEERING NUT
 CRASH PADS
 PADDOCK STAND
 MIRROR COVERS
 REAR-VIEW MIRRORS
 FOG LIGHTS KIT
 HANDLEBARS
 ACCESSORIES
 HANDLEBARS

POMPE FRENO Ø 16

BRAKE MASTER CYLINDERS Ø 16

■ Pompe freno Ø 16 CNC / CNC Brake Master Cylinders Ø 16

Codice Reference	Descrizione Description
CY006	Pompa freno radiale 16x18 CNC / CNC-worked brake master cylinder 16x18

Colori inserto e codino / Insets colours

N ● nero - black	O ● arancione - orange	Y ● oro - gold	B ● blu - blue
R ● rosso - red	S ● argento - silver	G ● verde - green	



■ Pompe freno Ø 16 forgiate / Forged Brake Master Cylinders Ø 16

Codice/Reference		Descrizione Description
Corpo nero Black body	Corpo naturale Natural body	
CL034	CY034	Pompa freno 16x16 forgiata, con leva fissa Forged brake master cylinder 16x16, with fix lever
CL033	CY033	Pompa freno 16x16 forgiata, con leva snodata Forged brake master cylinder 16x16, with folding lever
CL028	CY028	Pompa freno 16x18 forgiata, con leva fissa Forged brake master cylinder 16x18, with fix lever
CL027	CY027	Pompa freno 16x18 forgiata, con leva snodata Forged brake master cylinder 16x18, with folding lever
CL030	CY030	Pompa freno PRS 16x17-18-19 forgiata, con leva snodata PRS forged brake master cylinder 16x17-18-19, with folding lever



Colori leve / Lever Colours

Corpo nero
Black body
Serie CL

N ● nero - black	O ● arancione - orange	Y ● oro - gold	B ● blu - blue	R ● rosso - red	S ● argento - silver	G ● verde - green
----------------------------	----------------------------------	--------------------------	--------------------------	---------------------------	--------------------------------	-----------------------------

Corpo naturale
Natural body
Serie CY

N ● nero - black

Opzioni leva /Lever options

Lunga Long	17cm
Corta Short	15cm
Con RST With RST	

Nota: Solo nella versione black edition la leva è colorata
Note: Only in the black edition version the lever is colored

BRAKE/CLUTCH
MASTER CYLINDERS
 ACCESSORIES
SPARE PARTS
 CNC-WORKED FLUID
RESERVOIR
 FULL CLUTCH
 HYDRAULIC-CLUTCH
TRANFORMATION KIT
 LEVER
 THROTTLE CONTROL
 BRAKE CALIPER
 RACING KIT
 BUTTON PANEL
 LEVER GUARD
 CLIP-ON
 STREET RACING
REARSET
 FUEL CAPS
 STEERING NUT
 CRASH PADS
 PADDOCK STAND
 MIRROR COVERS
 REAR-VIEW MIRRORS
 FOG LIGHTS KIT
 HANDLEBARS
ACCESSORIES
 HANDLEBARS

■ Pompe freno Ø 16 "Revolution" / "Revolution" brake master cylinders Ø 16

Codice Reference	Descrizione Description
CL055	Pompa freno radiale 16x16 forgiata con leva revolution e corpo nero <i>Forged radial brake master cylinder 16x16 with revolution lever and black body</i>
CL056	Pompa freno radiale 16x18 forgiata con leva revolution e corpo nero <i>Forged radial brake master cylinder 16x18 with revolution lever and black body</i>
CL051	Pompa freno radiale PRS 16x17-18-19 forgiata con leva revolution e corpo nero <i>PRS forged radial brake master cylinder 16x17-18-19 with revolution lever and black body</i>



Colori inserti e codino / Insert and ending colours

N ●	O ●	Y ●	B ●	R ●	S ●	G ●
nero - black	arancione - orange	oro - gold	blu - blue	rosso - red	argento - silver	verde - green

Nota: Secondo inserto solo in nero / second insert in black color only
Note: Perno di regolazione e codino: stesso colore / adjusting knob & ending: same color

■ Pompe freno Ø 16 "Glow Blow" / "Glow Blow" brake master cylinders Ø 16

Codice Reference	Descrizione Description
CY044	Pompa freno radiale 16x16, con corpo pompa verniciato + leva "revolution" nera <i>Radial brake m. cly. 16x16, with coated body & black "revolution" lever</i>
CY045	Pompa freno radiale 16x18, con corpo pompa verniciato + leva "revolution" nera <i>Radial brake m. cly. 16x18, with coated body & black "revolution" lever</i>



Colori corpo pompa / Master cylinder body colours

N ●	Y ●	B ●	R ●	G ●	S ●
nero - black	giallo fluo fluorescent yellow	blu - blue	rosso - red	verde - green	argento - silver

BRAKE/CLUTCH
 MASTER CYLINDERS
 ACCESSORIES
 SPARE PARTS
 CNC-WORKED FLUID
 RESERVOIR
 FULL CLUTCH
 HYDRAULIC-CLUTCH
 TRANFORMATION KIT
 LEVER
 THROTTLE CONTROL
 BRAKE CALIPER
 RACING KIT
 BUTTON PANEL
 LEVER GUARD
 CLIP-ON
 STREET RACING
 REARSET
 FUEL CAPS
 STEERING NUT
 CRASH PADS
 PADDOCK STAND
 MIRROR COVERS
 REAR-VIEW MIRRORS
 FOG LIGHTS KIT
 HANDLEBARS
 ACCESSORIES
 HANDLEBARS

■ Pompe freno Ø 16 con vaschetta integrata / Brake master cylinders Ø 16 with integrated fluid reservoir



Codice Reference	Descrizione Description
PK034	Pompa freno 16x16 forgiata, con vaschetta integrata, con leva fissa <i>Forged brake master cylinder 16x16, with integrated fluid reservoir & fix lever</i>
PK033	Pompa freno 16x16 forgiata, con vaschetta integrata, con leva snodata <i>Forged brake master cylinder 16x16, with integrated fluid reservoir & folding lever</i>
PK028	Pompa freno 16x18 forgiata, con vaschetta integrata, con leva fissa <i>Forged brake master cylinder 16x18, with integrated fluid reservoir & fix lever</i>
PK027	Pompa freno 16x18 forgiata, con vaschetta integrata, con leva snodata <i>Forged brake master cylinder 16x18, with integrated fluid reservoir & folding lever</i>
PK030	Pompa freno PRS 16x17-18-19 forgiata, con vaschetta integrata, con leva snodata <i>PRS forged brake master cylinder 16x17-18-19, with integrated fluid reservoir & folding lever</i>

Colori leve e vaschetta / Levers colours and reservoir

N ●
nero - black

O ●
arancione - orange

Y ●
oro - gold

B ●
blu - blue

R ●
rosso - red

S ●
argento - silver

G ●
verde - green

BRAKE/CLUTCH
MASTER CYLINDERS

ACCESSORIES
SPARE PARTS

CNC-WORKED FLUID
RESERVOIR

FULL CLUTCH

HYDRAULIC-CLUTCH
TRANSFORMATION KIT

LEVER

THROTTLE CONTROL

BRAKE CALIPER

RACING KIT

BUTTON PANEL

LEVER GUARD

CLIP-ON

STREET RACING
REARSET

FUEL CAPS

STEERING NUT

CRASH PADS

Paddock STAND

MIRROR COVERS

REAR-VIEW MIRRORS

FOG LIGHTS KIT

HANDLEBARS
ACCESSORIES

HANDLEBARS

■ Pompa freno CNC Ø 16 "Ready to brake" / "Ready to brake" Brake Master Cylinders Ø 16

Codice Reference	Descrizione Description
CY084	Pompa freno CNC 16x16 con leva snodata CNC brake master cylinder 16x16 with folding lever
CY085	Pompa freno CNC 16x18 con leva snodata CNC brake master cylinder 16x18 with folding lever
CY086	Pompa freno CNC PRS 16x17-18-19 con leva snodata PRS CNC brake master cylinder 16x17-18-19 with folding lever

Opzioni leva /Lever options

Lunga / Long	17cm	Con RST / With RST
Corta / Short	15cm	Con RST / With RST

A = Microinterruttore incluso / Included Switch • B = Shark design
C = Bracciale sgancio rapido / Quick disconnecter hose clamp

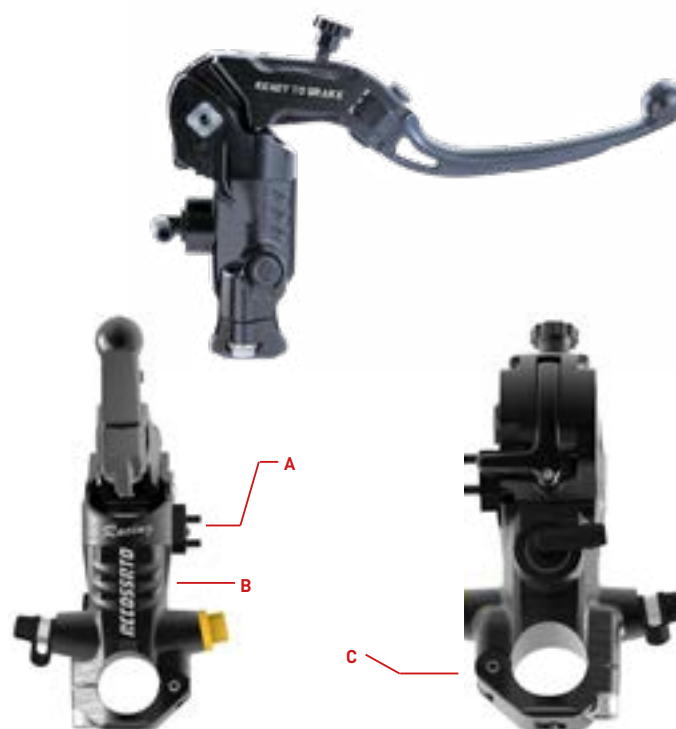

Colori impugnatura / Handle colours

N ●
nero - black

O ●
arancione
orange

Y ●
oro - gold

B ●
blu - blue

R ●
rosso - red

S ●
argento - silver

G ●
verde - green

BRAKE/CLUTCH
 MASTER CYLINDERS
 ACCESSORIES
 SPARE PARTS
 CNC-WORKED FLUID
 RESERVOIR
 FULL CLUTCH
 HYDRAULIC-CLUTCH
 TRANSFORMATION KIT
 LEVER
 THROTTLE CONTROL
 BRAKE CALIPER
 RACING KIT
 BUTTON PANEL
 LEVER GUARD
 CLIP-ON
 STREET RACING
 REARSET
 FUEL CAPS
 STEERING NUT
 CRASH PADS
 PADDOCK STAND
 MIRROR COVERS
 REAR-VIEW MIRRORS
 FOG LIGHTS KIT
 HANDLEBARS
 ACCESSORIES
 HANDLEBARS

POMPE FRENO Ø 15

BRAKE MASTER CYLINDERS Ø 15

■ Pompa freno radiali Ø 15 forgiate / Forged Brake Master Cylinders Ø 15 (Naked & Motard)

Codice/Reference		Descrizione Description
Corpo nero Black body	Corpo naturale Natural body	
CL067	CY067	Pompa freno forgiata 15x18 leva fissa Forged brake master cylinder 15x18 fix lever
CL068	CY068	Pompa freno forgiata 15x18 leva snodata Forged brake master cylinder 15x18 folding lever
CL069	CY069	Pompa freno forgiata 15x19 leva fissa Forged brake master cylinder 15x19 fix lever
CL070	CY070	Pompa freno forgiata 15x19 leva snodata Forged brake master cylinder 15x19 folding lever
CL071	CY071	Pompa freno forgiata 15x20 leva fissa Forged brake master cylinder 15x20 fix lever
CL072	CY072	Pompa freno forgiata 15x20 leva snodata Forged brake master cylinder 15x20 folding lever
CL073	CY073	Pompa freno forgiata PRS 15x17-18-19 leva snodata PRS Forged brake master cylinder 15x17-18-19 folding lever



Opzioni leva /Lever options

Lunga Long	17cm
Corta Short	15cm
Con RST With RST	

Colori leve / Lever Colours

Corpo nero
Black body
Serie CL

N ●
nero - black

O ●
arancione - orange

Y ●
oro - gold

B ●
blu - blue

R ●
rosso - red

S ●
argento - silver

G ●
verde - green

Corpo naturale
Natural body
Serie CY

N ●
nero - black

Nota: Solo nella versione black edition la leva è colorata
Note: Only in the black edition version the lever is colored

■ Pompa freno CNC Ø 15 "Ready to brake" / "Ready to brake" Brake Master Cylinders Ø 15

Codice Reference	Descrizione Description
CY113	Pompa freno CNC 15x18 con leva snodata CNC brake master cylinder 15x18 with folding lever
CY114	Pompa freno CNC 15x20 con leva snodata CNC brake master cylinder 15x20 with folding lever
CY115	Pompa freno CNC PRS 15x17-18-19 con leva snodata PRS CNC brake master cylinder 15x17-18-19 with folding lever

Opzioni leva /Lever options

Lunga / Long	17cm	Con RST / With RST
Corta / Short	15cm	Con RST / With RST

A = Microinterruttore incluso / Included Switch • B = Shark design
C = Bracciale sgancio rapido / Quick disconnecter hose clamp

Colori impugnatura / Handle colours

N ●
nero - black

O ●
arancione
orange

Y ●
oro - gold

B ●
blu - blue

R ●
rosso - red

S ●
argento - silver

G ●
verde - green



BRAKE/CLUTCH
MASTER CYLINDERS
 ACCESSORIES
SPARE PARTS
 CNC-WORKED FLUID
RESERVOIR
 FULL CLUTCH
 HYDRAULIC-CLUTCH
TRANFORMATION KIT
 LEVER
 THROTTLE CONTROL
 BRAKE CALIPER
 RACING KIT
 BUTTON PANEL
 LEVER GUARD
 CLIP-ON
 STREET RACING
REARSET
 FUEL CAPS
 STEERING NUT
 CRASH PADS
 PADDOCK STAND
 MIRROR COVERS
 REAR-VIEW MIRRORS
 FOG LIGHTS KIT
 HANDLEBARS
ACCESSORIES
 HANDLEBARS

POMPE FRENO Ø 14

BRAKE MASTER CYLINDERS Ø 14

■ Pompe freno Ø 14 forgiate / Forged Brake Master Cylinders Ø 14 (Scooter)

Codice/Reference		Descrizione Description
Corpo nero Black body	Corpo naturale Natural body	
CL060	CY060	Pompa freno forgiata 14x18 leva fissa Forged brake master cylinder 14x18 fix lever
CL061	CY061	Pompa freno forgiata 14x18 leva snodata Forged brake master cylinder 14x18 folding lever
CL062	CY062	Pompa freno forgiata 14x19 leva fissa Forged brake master cylinder 14x19 fix lever
CL063	CY063	Pompa freno forgiata 14x19 leva snodata Forged brake master cylinder 14x19 folding lever
CL064	CY064	Pompa freno forgiata 14x20 leva fissa Forged brake master cylinder 14x20 fix lever
CL065	CY065	Pompa freno forgiata 14x20 leva snodata Forged brake master cylinder 14x20 folding lever
CL066	CY066	Pompa freno forgiata PRS 14x17-18-19 leva snodata PRS Forged brake master cylinder 14x17-18-19 folding lever



Opzioni leva /Lever options

Lunga Long	17cm
Corta Short	15cm
Con RST With RST	

Colori leve / Lever Colours

Corpo nero
Black body
Serie CL



Corpo naturale
Natural body
Serie CY



Nota: Solo nella versione black edition la leva è colorata
Note: Only in the black edition version the lever is colored

■ Pompe freno CNC Ø 14 "Ready to brake" / "Ready to brake" Brake Master Cylinders Ø 14

Codice Reference	Descrizione Description
CY110	Pompa freno CNC 14x18 con leva snodata CNC brake master cylinder 14x18 with folding lever
CY111	Pompa freno CNC 14x20 con leva snodata CNC brake master cylinder 14x20 with folding lever
CY112	Pompa freno CNC PRS 14x17-18-19 con leva snodata PRS CNC brake master cylinder 14x17-18-19 with folding lever

Opzioni leva /Lever options

Lunga / Long	17cm	Con RST / With RST
Corta / Short	15cm	Con RST / With RST

A = Microinterruttore incluso / Included Switch • B = Shark design
C = Bracciale sgancio rapido / Quick disconnecter hose clamp

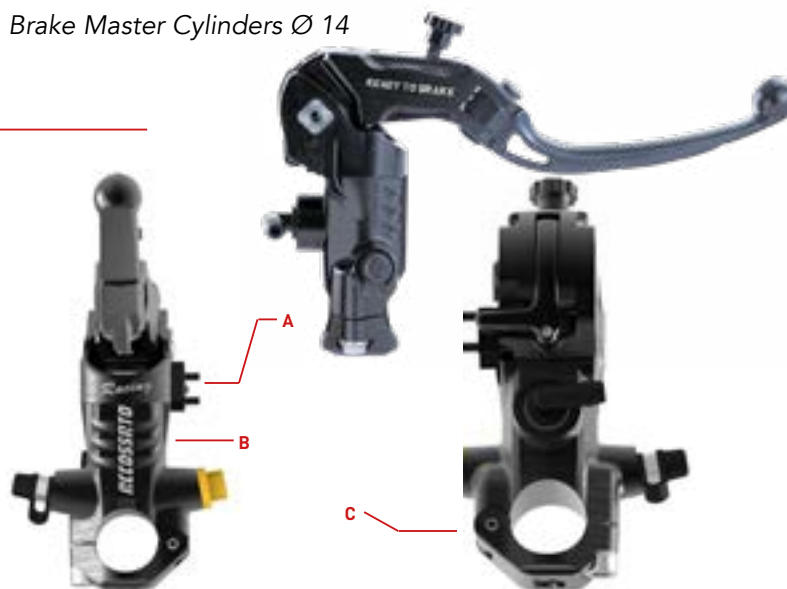

Colori impugnatura / Handle colours

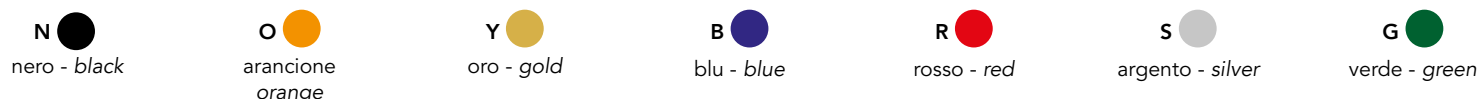

BRAKE/CLUTCH
MASTER CYLINDERS
 ACCESSORIES
SPARE PARTS
 CNC-WORKED FLUID
RESERVOIR
 FULL CLUTCH
 HYDRAULIC-CLUTCH
TRANFORMATION KIT
 LEVER
 THROTTLE CONTROL
 BRAKE CALIPER
 RACING KIT
 BUTTON PANEL
 LEVER GUARD
 CLIP-ON
 STREET RACING
REARSET
 FUEL CAPS
 STEERING NUT
 CRASH PADS
 PADDOCK STAND
 MIRROR COVERS
 REAR-VIEW MIRRORS
 FOG LIGHTS KIT
 HANDLEBARS
ACCESSORIES
 HANDLEBARS

POMPA FRENO RADIALE Ø 10

RADIAL MASTER CYLINDERS Ø 10



Codice
Reference

Modello
Model

CY010 | Pompa freno radiale Ø 10, con leva snodata e con vaschetta integrata
Radial brake master cylinder Ø 10, with folding lever and with integrated fluid reservoir

Colori leve e vaschetta / Lever colours and reservoir

N ●
nero - black

O ●
arancione
orange

Y ●
oro - gold

B ●
blu - blue

R ●
rosso - red

S ●
argento - silver

G ●
verde - green

BRAKE/CLUTCH
MASTER CYLINDERS

ACCESSORIES
SPARE PARTS

CNC-WORKED FLUID
RESERVOIR

FULL CLUTCH

HYDRAULIC-CLUTCH
TRANSFORMATION KIT

LEVER

THROTTLE CONTROL

BRAKE CALIPER

RACING KIT

BUTTON PANEL

LEVER GUARD

CLIP-ON

STREET RACING
REARSET

FUEL CAPS

STEERING NUT

CRASH PADS

Paddock STAND

MIRROR COVERS

REAR-VIEW MIRRORS

FOG LIGHTS KIT

HANDLEBARS
ACCESSORIES

HANDLEBARS

POMPE FRIZIONE Ø 19

CLUTCH MASTER CYLINDERS Ø 19

■ Pompe frizione Ø 19 forgiate / Forged Clutch master cylinders Ø 19

Codice/Reference		Descrizione
Corpo nero Black body	Corpo naturale Natural body	Description
CL038	CY038	Pompa frizione 19x20 forgiata, con leva snodata Forged clutch master cylinder 19x20, with folding lever
CL106	CY106	Pompa frizione 19x20, con leva fissa Forged clutch master cylinder 19x20, with fix lever



Note

Notes

** perno di regolazione:
stesso colore leva
adjusting knob: same
color as lever

Opzioni leva

Lever options

Lunga /Long: 17 cm	Corta /Short: 15 cm	Con RST with RST
-----------------------	------------------------	---------------------

Colori leve / Lever Colours

Corpo nero
Black body
Serie CL

N ●
nero - black

O ●
arancione - orange

Y ●
oro - gold

B ●
blu - blue

R ●
rosso - red

S ●
argento - silver

G ●
verde - green

Corpo naturale
Natural body
Serie CY

N ●
nero - black

BRAKE/CLUTCH
MASTER CYLINDERS
 ACCESSORIES
SPARE PARTS
 CNC-WORKED FLUID
RESERVOIR
 FULL CLUTCH
 HYDRAULIC-CLUTCH
TRANFORMATION KIT
 LEVER
 THROTTLE CONTROL
 BRAKE CALIPER
 RACING KIT
 BUTTON PANEL
 LEVER GUARD
 CLIP-ON
 STREET RACING
REARSET
 FUEL CAPS
 STEERING NUT
 CRASH PADS
 PADDOCK STAND
 MIRROR COVERS
 REAR-VIEW MIRRORS
 FOG LIGHTS KIT
 HANDLEBARS
ACCESSORIES
 HANDLEBARS

■ Pompe frizione Ø 19 con vaschetta integrata / Clutch master cylinders Ø 19 with integrated fluid reservoir



Codice Reference	Descrizione Description
PK038	Pompa frizione 19x20 forgiata, con vaschetta integrata, con leva snodata Forged clutch master cylinder 19x20, with integrated fluid reservoir & folding lever

Colori leve e vaschetta / Lever colours and reservoir

N ●
nero - black

O ●
arancione
orange

Y ●
oro - gold

B ●
blu - blue

R ●
rosso - red

S ●
argento - silver

G ●
verde - green

BRAKE/CLUTCH
MASTER CYLINDERS

ACCESSORIES
SPARE PARTS

CNC-WORKED FLUID
RESERVOIR

FULL CLUTCH

HYDRAULIC-CLUTCH
TRANFORMATION KIT

LEVER

THROTTLE CONTROL

BRAKE CALIPER

RACING KIT

BUTTON PANEL

LEVER GUARD

CLIP-ON

STREET RACING
REARSET

FUEL CAPS

STEERING NUT

CRASH PADS

PADDOCK STAND

MIRROR COVERS

REAR-VIEW MIRRORS

FOG LIGHTS KIT

HANDLEBARS
ACCESSORIES

HANDLEBARS

POMPE FRIZIONE Ø 17

CLUTCH MASTER CYLINDERS Ø 17

■ Pompa frizione Ø 17 forgiata / Forged Clutch Master Cylinder Ø 17

Codice/Reference		Descrizione Description
Corpo nero Black body	Corpo naturale Natural body	
CL083	CY083	Pompa frizione forgiata PRS 17x15-16-17 leva snodata Forged PRS clutch master cylinder 17x15-16-17 folding lever

Opzioni leva /Lever options

Lunga / Long	17cm
Corta / Short	15cm
Con RST / With RST	



Colori leve / Lever Colours

Corpo naturale
Natural body
Serie CY

N ●
nero - black

Corpo nero
Black body
Serie CL

N ●
nero - black

O ●
arancione - orange

Y ●
oro - gold

B ●
blu - blue

R ●
rosso - red

S ●
argento - silver

G ●
verde - green

- BRAKE/CLUTCH MASTER CYLINDERS
- ACCESSORIES SPARE PARTS
- CNC-WORKED FLUID RESERVOIR
- FULL CLUTCH
- HYDRAULIC-CLUTCH TRANFORMATION KIT
- LEVER
- THROTTLE CONTROL
- BRAKE CALIPER
- RACING KIT
- BUTTON PANEL
- LEVER GUARD
- CLIP-ON
- STREET RACING REARSET
- FUEL CAPS
- STEERING NUT
- CRASH PADS
- PADDOCK STAND
- MIRROR COVERS
- REAR-VIEW MIRRORS
- FOG LIGHTS KIT
- HANDLEBARS ACCESSORIES
- HANDLEBARS

POMPE FRIZIONE Ø 16

CLUTCH MASTER CYLINDERS Ø 16

■ Pompe frizione Ø 16 CNC / CNC Clutch Master Cylinders Ø 16

Codice Reference	Descrizione Description
CY007	Pompa freno radiale 16x18 CNC / CNC-worked brake master cylinder 16x18
CY005	Pompa frizione PRS 16x15-16-17 CNC CNC-worked PRS clutch master cylinder 16x15-16-17

Colori inserto e codino / Insets colours

N ● nero - black	O ● arancione - orange	Y ● oro - gold	B ● blu - blue
R ● rosso - red	S ● argento - silver	G ● verde - green	



■ Pompe frizione Ø 16 forgiate / Forged Clutch master cylinders Ø 16

Codice/Reference		Descrizione Description
Corpo nero Black body	Corpo naturale Natural body	
CL026	CY026	Pompa frizione 16x16 forgiate, con leva fissa Forged clutch master cylinder 16x16, with fix lever
CL025	CY025	Pompa frizione 16x16 forgiate, con leva snodata Forged clutch master cylinder 16x16, with folding lever
CL032	CY032	Pompa frizione 16x18 forgiate, con leva fissa Forged clutch master cylinder 16x18, with fix lever
CL031	CY031	Pompa frizione 16x18 forgiate, con leva snodata Forged clutch master cylinder 16x18, with folding lever
CL024	CY024	Pompa frizione PRS 16x15-16-17 forgiate, con leva snodata PRS forged clutch master cylinder 16x15-16-17, with folding lever

Note Notes

** perno di regolazione:
stesso colore leva
adjusting knob: same
color as lever

Opzioni leva Lever options

Lunga /Long: 17 cm	Corta /Short: 15 cm	Con RST with RST
-----------------------	------------------------	---------------------

Colori leve / Lever Colours

Corpo nero Black body Serie CL	N ● nero - black	O ● arancione - orange	Y ● oro - gold	B ● blu - blue	R ● rosso - red	S ● argento - silver	G ● verde - green
Corpo naturale Natural body Serie CY	N ● nero - black						



BRAKE/CLUTCH
MASTER CYLINDERS
 ACCESSORIES
SPARE PARTS
 CNC-WORKED FLUID
RESERVOIR
 FULL CLUTCH
 HYDRAULIC-CLUTCH
TRANFORMATION KIT
 LEVER
 THROTTLE CONTROL
 BRAKE CALIPER
 RACING KIT
 BUTTON PANEL
 LEVER GUARD
 CLIP-ON
 STREET RACING
REARSET
 FUEL CAPS
 STEERING NUT
 CRASH PADS
 PADDOCK STAND
 MIRROR COVERS
 REAR-VIEW MIRRORS
 FOG LIGHTS KIT
 HANDLEBARS
ACCESSORIES
 HANDLEBARS

■ Pompe frizione Ø 16 forgiate / Forged clutch master cylinders Ø 16

Codice Reference	Descrizione Description
CL059	Pompa frizione radiale 16x16 forgiata con leva revolution e corpo nero <i>Forged radial clutch master cylinder 16x16 with revolution lever and black body</i>
CL058	Pompa frizione radiale 16x18 forgiata con leva revolution e corpo nero <i>Forged radial clutch master cylinder 16x18 with revolution lever and black body</i>
CL052	Pompa frizione radiale PRS 16x15-16-17 forgiata con leva revolution e corpo nero <i>PRS forged radial clutch master cylinder 16x15-16-17, with revolution lever and black body</i>



Colori inserti e codino / Insert and ending colours

N ●	O ●	Y ●	B ●	R ●	S ●	G ●
nero - black	arancione - orange	oro - gold	blu - blue	rosso - red	argento - silver	verde - green

■ Pompe frizione Ø 16 con vaschetta integrata / Clutch master cylinders Ø 16 with integrated fluid reservoir

Codice Reference	Descrizione Description
PK026	Pompa frizione 16x16 forgiata, con vaschetta integrata, con leva fissa <i>Forged clutch master cylinder 16x16, with integrated fluid reservoir & fix lever</i>
PK025	Pompa frizione 16x16 forgiata, con vaschetta integrata, con leva snodata <i>Forged clutch master cylinder 16x16, with integrated fluid reservoir & folding lever</i>
PK032	Pompa frizione 16x18 forgiata, con vaschetta integrata, con leva fissa <i>Forged clutch master cylinder 16x18, with integrated fluid reservoir & fix lever</i>
PK031	Pompa frizione 16x18 forgiata, con vaschetta integrata, con leva snodata <i>Forged clutch master cylinder 16x18, with integrated fluid reservoir & folding lever</i>
PK024	Pompa frizione PRS 16x15-16-17 forgiata, con vaschetta integrata, con leva snodata <i>PRS forged clutch master cylinder 16x15-16-17, with integrated fluid reservoir & folding lever</i>



Colori leve e vaschetta / Levers colours and reservoir

N ●	O ●	Y ●	B ●	R ●	S ●	G ●
nero - black	arancione - orange	oro - gold	blu - blue	rosso - red	argento - silver	verde - green

- BRAKE/CLUTCH MASTER CYLINDERS
- ACCESSORIES SPARE PARTS
- CNC-WORKED FLUID RESERVOIR
- FULL CLUTCH
- HYDRAULIC-CLUTCH TRANFORMATION KIT
- LEVER
- THROTTLE CONTROL
- BRAKE CALIPER
- RACING KIT
- BUTTON PANEL
- LEVER GUARD
- CLIP-ON
- STREET RACING REARSET
- FUEL CAPS
- STEERING NUT
- CRASH PADS
- PADDOCK STAND
- MIRROR COVERS
- REAR-VIEW MIRRORS
- FOG LIGHTS KIT
- HANDLEBARS ACCESSORIES
- HANDLEBARS

■ Pompa frizione CNC Ø 16 "Ready to brake" / "Ready to brake" CNC Clutch Master Cylinders Ø 16

Codice Reference	Descrizione Description
CY104	Pompa frizione CNC PRS 16x15-16-17 con leva snodata PRS CNC clutch master cylinder 16x15-16-17 with folding lever



Opzioni leva /Lever options

Lunga / Long	17cm	Con RST / With RST
Corta / Short	15cm	Con RST / With RST

Colori impugnatura / Handle colours

N 
nero - black

O 
arancione
orange

Y 
oro - gold

B 
blu - blue

R 
rosso - red

S 
argento - silver

G 
verde - green

BRAKE/CLUTCH
MASTER CYLINDERS

ACCESSORIES
SPARE PARTS

CNC-WORKED FLUID
RESERVOIR

FULL CLUTCH

HYDRAULIC-CLUTCH
TRANSFORMATION KIT

LEVER

THROTTLE CONTROL

BRAKE CALIPER

RACING KIT

BUTTON PANEL

LEVER GUARD

CLIP-ON

STREET RACING
REARSET

FUEL CAPS

STEERING NUT

CRASH PADS

Paddock STAND

MIRROR COVERS

REAR-VIEW MIRRORS

FOG LIGHTS KIT

HANDLEBARS
ACCESSORIES

HANDLEBARS

POMPE FRIZIONE Ø 15

CLUTCH MASTER CYLINDERS Ø 15

■ Pompa frizione Ø 15 forgiata / Forged Clutch Master Cylinder Ø 15

Codice/Reference		Descrizione Description
Corpo nero Black body	Corpo naturale Natural body	
CL082	CY082	Pompa frizione forgiata PRS 15x15-16-17 con leva snodata PRS forged clutch master cylinder 15x15-16-17 with folding lever

Opzioni leva /Lever options

Lunga / Long	17cm
Corta / Short	15cm
Con RST / With RST	



Colori leve / Lever Colours

Corpo naturale
Natural body
Serie CY

N ●
nero - black

Corpo nero
Black body
Serie CL

N ●
nero - black

O ●
arancione - orange

Y ●
oro - gold

B ●
blu - blue

R ●
rosso - red

S ●
argento - silver

G ●
verde - green

- BRAKE/CLUTCH MASTER CYLINDERS
- ACCESSORIES SPARE PARTS
- CNC-WORKED FLUID RESERVOIR
- FULL CLUTCH
- HYDRAULIC-CLUTCH TRANSFORMATION KIT
- LEVER
- THROTTLE CONTROL
- BRAKE CALIPER
- RACING KIT
- BUTTON PANEL
- LEVER GUARD
- CLIP-ON
- STREET RACING REARSET
- FUEL CAPS
- STEERING NUT
- CRASH PADS
- Paddock STAND
- MIRROR COVERS
- REAR-VIEW MIRRORS
- FOG LIGHTS KIT
- HANDLEBARS ACCESSORIES
- HANDLEBARS

POMPE FRIZIONE Ø 14

CLUTCH MASTER CYLINDERS Ø 14

■ Pompa frizione Ø 14 forgiata / Forged Clutch Master Cylinder Ø 14

Codice/Reference		Descrizione
Corpo nero Black body	Corpo naturale Natural body	Descrizione Description
CL081	CY081	Pompa frizione forgiata PRS 14x15-16-17 con leva snodata PRS forged clutch master cylinder 14x15-16-17 with folding lever

Opzioni leva /Lever options

Lunga / Long	17cm
Corta / Short	15cm
Con RST / With RST	



Colori leve / Lever Colours

Corpo naturale
Natural body
Serie CY

N ●
nero - black

Corpo nero
Black body
Serie CL

N ●
nero - black

O ●
arancione - orange

Y ●
oro - gold

B ●
blu - blue

R ●
rosso - red

S ●
argento - silver

G ●
verde - green

BRAKE/CLUTCH
MASTER CYLINDERS
 ACCESSORIES
SPARE PARTS
 CNC-WORKED FLUID
RESERVOIR
 FULL CLUTCH
 HYDRAULIC-CLUTCH
TRANFORMATION KIT
 LEVER
 THROTTLE CONTROL
 BRAKE CALIPER
 RACING KIT
 BUTTON PANEL
 LEVER GUARD
 CLIP-ON
 STREET RACING
REARSET
 FUEL CAPS
 STEERING NUT
 CRASH PADS
 PADDOCK STAND
 MIRROR COVERS
 REAR-VIEW MIRRORS
 FOG LIGHTS KIT
 HANDLEBARS
ACCESSORIES
 HANDLEBARS

POMPA FRENO A POLLICE

THUMB MASTER CYLINDER



BRAKE/CLUTCH
MASTER CYLINDERS

ACCESSORIES
SPARE PARTS

CNC-WORKED FLUID
RESERVOIR

FULL CLUTCH

HYDRAULIC-CLUTCH
TRANSFORMATION KIT

LEVER

THROTTLE CONTROL

BRAKE CALIPER

RACING KIT

BUTTON PANEL

LEVER GUARD

CLIP-ON

STREET RACING
REARSET

FUEL CAPS

STEERING NUT

CRASH PADS

Paddock STAND

MIRROR COVERS

REAR-VIEW MIRRORS

FOG LIGHTS KIT

HANDLEBARS
ACCESSORIES

HANDLEBARS

■ Pompa freno a pollice con leva corta / *Thumb brake master cylinder with short lever*

Codice Reference	Caratteristiche tecniche Technical details
BP001	Ø Pompante / piston 10,5 mm
	Peso / weight 150 gr
	Staffa di supporto non inclusa / bracket not included
	Attacco tubi freno 8 mm / Brake hose connection 8 mm
BP002	Ø Pompante / piston 10,5 mm
	Staffa di supporto inclusa / bracket included
BP007	Ø Pompante / piston 13,5 mm NEW
	Peso / weight 150 gr
	Staffa di supporto non inclusa / bracket not included
	Attacco tubi freno 10 mm / Brake hose connection 10 mm
BP008	Ø Pompante / piston 13,5 mm NEW
	Staffa di supporto inclusa / bracket included

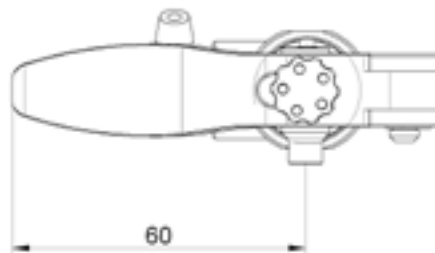

■ Pompa freno a pollice con leva lunga / *Thumb brake master cylinder with long lever*

Codice Reference	Caratteristiche tecniche Technical details
BP003	Ø Pompante / piston 10,5 mm
	Peso / weight 150 gr
	Staffa di supporto non inclusa / bracket not included
	Attacco tubi freno 8 mm / Brake hose connection 8 mm
BP004	Ø Pompante / piston 10,5 mm
	Staffa di supporto inclusa / bracket included
BP009	Ø Pompante / piston 13,5 mm NEW
	Peso / weight 150 gr
	Staffa di supporto non inclusa / bracket not included
	Attacco tubi freno 10 mm / Brake hose connection 10 mm
BP010	Ø Pompante / piston 13,5 mm NEW
	Staffa di supporto inclusa / bracket included

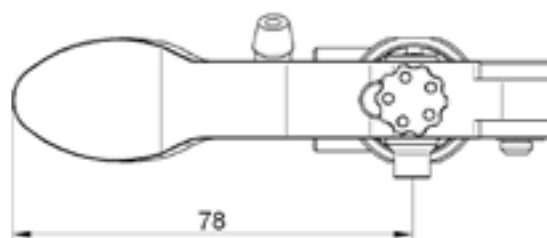

■ Pompa freno a pollice con leva curva / *Thumb brake master cylinder with bent lever*

Codice Reference	Caratteristiche tecniche Technical details
BP005	Ø Pompante / piston 10,5 mm
	Peso / weight 150 gr
	Staffa di supporto non inclusa / bracket not included
	Attacco tubi freno 8 mm / Brake hose connection 8 mm
BP006	Ø Pompante / piston 10,5 mm
	Staffa di supporto inclusa / bracket included
BP011	Ø Pompante / piston 13,5 mm NEW
	Peso / weight 150 gr
	Staffa di supporto non inclusa / bracket not included
	Attacco tubi freno 10 mm / Brake hose connection 10 mm
BP012	Ø Pompante / piston 13,5 mm NEW
	Staffa di supporto inclusa / bracket included

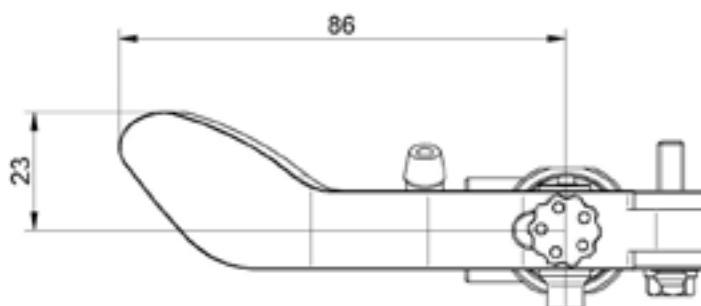

■ Accessori / Accessories

Codice Reference	Descrizione Description
BS001	Leva corta pompa a pollice / <i>Short lever for thumb master cylinder</i>
BS002	Leva lunga pompa a pollice / <i>Long lever for thumb master cylinder</i>
BS003	Leva curva pompa a pollice / <i>Bent lever for thumb master cylinder</i>
BS004	Staffa di supporto / <i>Bracket</i>

Note: Si sconsiglia il montaggio in abbinamento con pompe freno posteriori a pedale originali, per mantenere il freno a pedale si consiglia l'abbinamento con la pompa posteriore MP005

Note: Not to install with OEM rear pedal brake master cylinder to maintain the foot brake, it is recommended to combine it with the MP005 rear master cylinder

BRAKE/CLUTCH
MASTER CYLINDERS
 ACCESSORIES
SPARE PARTS
 CNC-WORKED FLUID
RESERVOIR
 FULL CLUTCH
 HYDRAULIC-CLUTCH
TRANSFORMATION KIT
 LEVER
 THROTTLE CONTROL
 BRAKE CALIPER
 RACING KIT
 BUTTON PANEL
 LEVER GUARD
 CLIP-ON
 STREET RACING
REARSET
 FUEL CAPS
 STEERING NUT
 CRASH PADS
 PADDOCK STAND
 MIRROR COVERS
 REAR-VIEW MIRRORS
 FOG LIGHTS KIT
 HANDLEBARS
ACCESSORIES
 HANDLEBARS

POMPA FRENO POSTERIORE HRMC

HAND REAR BRAKE MASTER CYLINDER

La Pompa freno posteriore Accossato HRMC permette di attivare il freno posteriore con la mano sinistra, agevolando e correggendo l'ingresso in curva, al fine di modulare la frenata.

The rear Accossato HRMC master cylinder allows to start the rear brake with the left hand, easing and correcting the entry into the curve in order to modulate braking.'



BRAKE/CLUTCH
MASTER CYLINDERS

ACCESSORIES
SPARE PARTS

CNC-WORKED FLUID
RESERVOIR

FULL CLUTCH

HYDRAULIC-CLUTCH
TRANFORMATION KIT

LEVER

THROTTLE CONTROL

BRAKE CALIPER

RACING KIT

BUTTON PANEL

LEVER GUARD

CLIP-ON

STREET RACING
REARSET

FUEL CAPS

STEERING NUT

CRASH PADS

Paddock STAND

MIRROR COVERS

REAR-VIEW MIRRORS

FOG LIGHTS KIT

HANDLEBARS
ACCESSORIES

HANDLEBARS

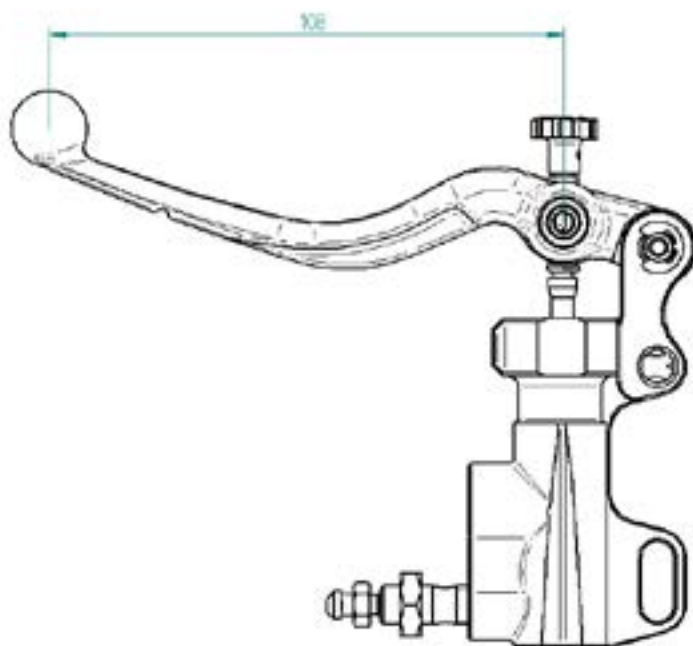

■ Pompa freno HRMC / Hand brake master cylinder

Codice Reference	Caratteristiche tecniche Technical details
MP002	Ø Pompante / piston 10,5 mm
	Peso / weight 160 g senza staffa / without bracket
	Staffa di supporto inclusa / Bracket included
	Attacco tubi freno 8 mm / Brake hose connection 8 mm
MP004	Ø Pompante / piston 13,5 mm
	Peso / weight 160 g senza staffa / without bracket
	Staffa di supporto inclusa / Bracket included
	Attacco tubi freno 10 mm / Brake hose connection 10 mm

NEW

■ Accessori / Accessories

Codice Reference	Descrizione Description
BS005	Leva HRMC / Lever HRMC
BS006	Staffa di supporto / Bracket

Note: Si sconsiglia il montaggio in abbinamento con pompe freno posteriori a pedale originali, per mantenere il freno a pedale si consiglia l'abbinamento con la pompa posteriore MP005

Note: Not to install with OEM rear pedal brake master cylinder, to maintain the rear pedal brake it is recommended to combine it with the MP005 rear master cylinder

BRAKE/CLUTCH
MASTER CYLINDERS

ACCESSORIES
SPARE PARTS

CNC-WORKED FLUID
RESERVOIR

FULL CLUTCH

HYDRAULIC-CLUTCH
TRANSFORMATION KIT

LEVER

THROTTLE CONTROL

BRAKE CALIPER

RACING KIT

BUTTON PANEL

LEVER GUARD

CLIP-ON

STREET RACING
REARSET

FUEL CAPS

STEERING NUT

CRASH PADS

Paddock STAND

MIRROR COVERS

REAR-VIEW MIRRORS

FOG LIGHTS KIT

HANDLEBARS
ACCESSORIES

HANDLEBARS

POMPA FRENO POSTERIORE

REAR BRAKE MASTER CYLINDER



■ Pompa freno posteriore / Rear brake master cylinder

Codice Reference	Caratteristiche tecniche Technical details
MP001	Ø Pompante / piston 10,5 mm
	Interasse fori di fissaggio / bolt pattern 40-50 mm
	Peso / weight 75 gr
	Attacco tubi freno 8 mm / Brake hose connection 8 mm
MP003	Ø Pompante / piston 13,5 mm
	Interasse fori di fissaggio / bolt pattern 40-50 mm
	Peso / weight 75 gr
	Attacco tubi freno 10 mm / Brake hose connection 10 mm

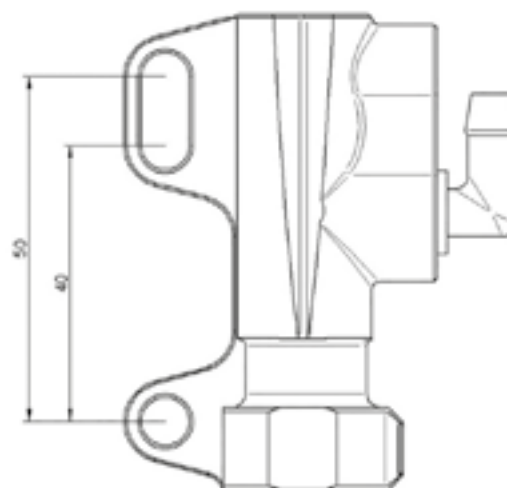

Note: Si sconsiglia il montaggio in abbinamento con pompe freno a pollice

Note: Not to install with thumb brake master cylinder

- BRAKE/CLUTCH MASTER CYLINDERS
- ACCESSORIES SPARE PARTS
- CNC-WORKED FLUID RESERVOIR
- FULL CLUTCH
- HYDRAULIC-CLUTCH TRANFORMATION KIT
- LEVER
- THROTTLE CONTROL
- BRAKE CALIPER
- RACING KIT
- BUTTON PANEL
- LEVER GUARD
- CLIP-ON
- STREET RACING REARSET
- FUEL CAPS
- STEERING NUT
- CRASH PADS
- PADDOCK STAND
- MIRROR COVERS
- REAR-VIEW MIRRORS
- FOG LIGHTS KIT
- HANDLEBARS ACCESSORIES
- HANDLEBARS



■ Pompa freno posteriore con doppio attacco / *Rear brake master cylinder with double connection* **NEW**

La pompa freno con doppio attacco permette di essere montata in abbinamento ad una pompa posteriore a manubrio mantenendo l'uso del pedale
The double-ended brake pump allows it to be mounted in conjunction with a rear handlebar pump while maintaining the use of the pedal brake

Codice Reference	Caratteristiche tecniche Technical details
MP005	Ø Pompante / piston 13,5 mm
	Interasse fori di fissaggio / bolt pattern 40-50 mm
	Peso / weight 75 gr
	Attacco tubi freno 10 mm / Brake hose connection 10 mm

- BRAKE/CLUTCH MASTER CYLINDERS
- ACCESSORIES SPARE PARTS
- CNC-WORKED FLUID RESERVOIR
- FULL CLUTCH
- HYDRAULIC-CLUTCH TRANSFORMATION KIT
- LEVER
- THROTTLE CONTROL
- BRAKE CALIPER
- RACING KIT
- BUTTON PANEL
- LEVER GUARD
- CLIP-ON
- STREET RACING REARSET
- FUEL CAPS
- STEERING NUT
- CRASH PADS
- PADDOCK STAND
- MIRROR COVERS
- REAR-VIEW MIRRORS
- FOG LIGHTS KIT
- HANDLEBARS ACCESSORIES
- HANDLEBARS









■ Pompa freno posteriore con vaschetta integrata / Rear brake master cylinder with integrated fluid reservoir **NEW**

Codice Reference	Caratteristiche tecniche Technical details
MP006	Ø Pompante / piston 13,5 mm
	Interasse fori di fissaggio / bolt pattern 40-50 mm
	Peso / weight 160 gr
	Attacco tubi freno 10 mm / Brake hose connection 10 mm

■ Accessori / Accessories

Codice Reference	Descrizione Description
RC020	Coperchio di ricambio / Spare reservoir cap
RC021	Guarnizione vaschetta di ricambio / Spare rubber reservoir seal
RC055	Cuffia in gomma di ricambio / Spare rubber cap

Colori coperchio vaschetta / Reservoir cap colours

N 	O 	Y 	B 	R 	S 	G 
nero - black	arancione orange	oro - gold	blu - blue	rosso - red	argento - silver	verde - green

Note: Si sconsiglia il montaggio in abbinamento con pompe freno a pollice

Note: Not to install with thumb brake master cylinder

BRAKE/CLUTCH
 MASTER CYLINDERS
 ACCESSORIES
 SPARE PARTS
 CNC-WORKED FLUID
 RESERVOIR
 FULL CLUTCH
 HYDRAULIC-CLUTCH
 TRANSFORMATION KIT
 LEVER
 THROTTLE CONTROL
 BRAKE CALIPER
 RACING KIT
 BUTTON PANEL
 LEVER GUARD
 CLIP-ON
 STREET RACING
 REARSET
 FUEL CAPS
 STEERING NUT
 CRASH PADS
 PADDOCK STAND
 MIRROR COVERS
 REAR-VIEW MIRRORS
 FOG LIGHTS KIT
 HANDLEBARS
 ACCESSORIES
 HANDLEBARS

FLUIDO FRENI

BRAKE FLUID

Accossato racing brake fluid DOT 4

Descrizione e applicazione

Description and application

Fluido freni a base sintetica da utilizzarsi nei circuiti idraulici sia di freni a disco che a tamburo. DOT 4 è idoneo per l'utilizzo nelle autovetture, nei veicoli industriali e commerciali, nelle moto e negli scooter. DOT 4, grazie al suo elevato punto di ebollizione, evita la formazione di bolle nel circuito frenante (Vapor Lock).

DOT 4, essendo dotato di un basso punto di scorrimento, garantisce una buona frenata anche a basse temperature. DOT 4, possedendo un'ottima compatibilità con le gomme e le guarnizioni dei circuiti frenanti, evita sia i rigonfiamenti che gli infragilimenti dei manicotti in gomma o della plastica delle tenute. DOT 4 protegge le parti metalliche che compongono il circuito frenante dalla ruggine, dall'ossidazione e dalla corrosione.

DOT 4 risponde alle seguenti specifiche : - SAE J 1703 D - DOT 4 - FMVSS 116 - ISO 4925

Accossato DOT 4 is a synthetic fluid which can be used both with disc and drum brakes. It is also suitable for cars, industrial and commercial vehicles, motorcycles and scooters. The elevated boiling point of DOT 4 avoids the "Vapor Lock" effect.

Its low pour point allows a performing braking even at low temperatures. DOT 4 is highly compatible with brake's gaskets and rubbers, thus avoiding any kind of swelling or embrittlement. It protects metallic parts from rust, oxidation and corrosion.

DOT 4 meets the following specifications: SAE J 1703 D – DOT 4 – FMVSS 116 – ISO 4925

Caratteristiche

Details

Aspetto / Aspect: Limpido / Limpid

Colore/Colour: Da giallo chiaro ad ambrato / from light yellow to amber

Peso specifico a 15°C: 1,010 – 1,090 Kg /dm³

Punto di ebollizione a secco / Boiling Point (dry): Min. 260 °C

Punto di ebollizione a umido / Boiling Point (wet): Min. 155 °C



- BRAKE/CLUTCH MASTER CYLINDERS
- ACCESSORIES SPARE PARTS
- CNC-WORKED FLUID RESERVOIR
- FULL CLUTCH
- HYDRAULIC-CLUTCH TRANSFORMATION KIT
- LEVER
- THROTTLE CONTROL
- BRAKE CALIPER
- RACING KIT
- BUTTON PANEL
- LEVER GUARD
- CLIP-ON
- STREET RACING REARSET
- FUEL CAPS
- STEERING NUT
- CRASH PADS
- Paddock STAND
- MIRROR COVERS
- REAR-VIEW MIRRORS
- FOG LIGHTS KIT
- HANDLEBARS ACCESSORIES
- HANDLEBARS

Accossato racing brake fluid DOT 5.1

Descrizione e applicazione

Description and application

Fluido speciale, totalmente sintetico, da utilizzarsi nei circuiti idraulici sia di freni a disco che a tamburo. DOT 5.1 può essere utilizzato in assoluta sicurezza sia nella guida estremamente sportiva che nelle competizioni, vista la sua elevata stabilità alle alte temperature. Nel caso di utilizzo a temperature elevate, il suo elevatissimo punto di ebollizione evita la formazione di bolle nel circuito frenante. Il fatto che il prodotto si mantenga fluido anche a basse temperature garantisce una buona frenata anche in climi particolarmente rigidi. DOT 5.1, essendo un olio freni ad alto punto di ebollizione, può essere utilizzato anche quando, a causa di azioni frenanti particolarmente spinte e/o prolungate, nei circuiti frenanti si raggiungono temperature particolarmente elevate.

DOT 5.1 non provoca particolari rigonfiamenti delle gomme di tenuta degli impianti frenanti e non agredisce i metalli che compongono l'impianto. DOT 5.1 ha buone proprietà sia lubrificanti che antiusura che garantiscono un buon funzionamento degli organi presenti nei circuiti e diminuiscono l'usura delle parti in movimento. La sua elevata stabilità chimica fa sì che il prodotto non subisca particolari alterazioni anche se sottoposto all'effetto di sollecitazioni termiche particolarmente elevate.

DOT 5.1 risponde alle seguenti specifiche :

- SAE J 1703 - DOT 5.1 - DOT 4 - DOT 3 - US FMVSS 571.116

Special synthetic fluid which can be used both with disc and drum brakes. Due to its elevated stability at high temperatures, it is suitable for competitions as well as for sporty driving. Its very elevated boiling point avoids the "Vapour Lock" effect. Maintaining its fluidity even at low temperatures, it guarantees a performing braking even in extremely cold conditions. DOT 5.1 has a very high boiling point, therefore it can be used in case of prolonged or late braking, when the braking system reaches high temperatures.

DOT 5.1 does not cause the swelling of brake's rubbers and does not damage its metallic components. Its lubricating and antiwear properties guarantee a good functioning brake's part and diminish the wearing of moving components. The elevated chemical stability of DOT 5.1 oil guarantees the absence of any alteration in case of extreme temperatures.

DOT 5.1 meets the following specifications:

SAE J 1703 D - DOT 4 - DOT 5.1 - US FMVSS 571.116 - ISO 4925

Caratteristiche

Details

Aspetto / Aspect: Limpido / Limpid

Colore/Colour: Paglierino / Straw-coloured

Peso specifico a 15°C ASTM D 1298: 1,00 - 1,09 Kg /dm³

Punto di ebollizione a secco / Boiling Point (dry): Min. 275 °C

Punto di ebollizione a umido / Boiling Point (wet): Min. 185 °C

Note: Si consiglia di rimuovere dall'impianto frenante dopo l'utilizzo in pista e sostituirlo con il fluido DOT4

Note: We recommend to remove from the brake system after using on track and replace it with DOT4 brake fluid



BRAKE/CLUTCH
MASTER CYLINDERS

ACCESSORIES
SPARE PARTS

CNC-WORKED FLUID
RESERVOIR

FULL CLUTCH

HYDRAULIC-CLUTCH
TRANFORMATION KIT

LEVER

THROTTLE CONTROL

BRAKE CALIPER

RACING KIT

BUTTON PANEL

LEVER GUARD

CLIP-ON

STREET RACING
REARSET

FUEL CAPS

STEERING NUT

CRASH PADS

PADDOCK STAND

MIRROR COVERS

REAR-VIEW MIRRORS

FOG LIGHTS KIT

HANDLEBARS
ACCESSORIES

HANDLEBARS

Accossato racing brake fluid DOT 6

Descrizione e applicazione

Description and application

Fluido speciale Per tutti i tipi di impianti idraulici di freni e frizioni che richiedano un fluido non silconico. Sviluppato per resistere alle temperature estreme generate nei freni da competizione ceramici o in carbonio, permettendo un flusso di aria per il raffreddamento minore. Può essere utilizzato anche con dischi in acciaio convenzionali. Supera le richieste degli standard DOT 3, DOT 4 e DOT 5.1. La viscosità simile a quella del DOT 4 permette, a temperature alte di esercizio, una viscosità ottimale mantenendo i tempi di frenata anche per lunghi periodi.

DOT 6 RACING ha un elevato punto di ebollizione (almeno +315°C), superiore ai fluidi convenzionali DOT 5.1

(260°C min.) e DOT 4 (230°C min.). Evita il fenomeno del "vapour lock" (presenza di bolle di vapore nel circuito freni), Wet Boiling Point 204°C min, superiore ai fluidi freni convenzionali DOT 5.1 non silconici (180°C min.)

e DOT 4 (155°C min.), permette un livello di frenata efficiente anche in condizioni di umidità.

DOT 6 RACING possiede ottime proprietà anti-corrosione, ruggine ed ossidazione per la protezione dei componenti metallici e non costituenti il circuito di frenata. Totale compatibilità con gomme e guarnizioni per evitare rigonfiamenti o fragilità dei manicotti in gomma o plastica e delle tenute. Elevata stabilità chimica per garantire l'inalterabilità nelle condizioni più severe di sollecitazione termica. Può essere utilizzato in macchinario di ogni marca, tipo e potenza.

DOT 6 RACING è pronto all'uso. E' un liquido freni a base sintetica, miscibile con tutti i liquidi freni della stessa tipologia.

NON MISCIBILE CON LIQUIDI FRENI A BASE SILCONICA O CON FLUIDI MINERALI (LHM).

Special fluid for all kinds of hydraulic system of brakes and clutches requiring a non-silicone oil. It was developed to resist at extreme temperatures, which are usually reached in competition brakes made of ceramic or carbon, by diminishing the airflow for heat reduction. It can be also used with conventional steel discs. It meets standard specifications for DOT 3, DOT 4 and DOT 5.1. Its viscosity, alike DOT 4, allows it to resist at high temperatures, reaching an optimal viscosity during prolonged braking.

DOT 6 Racing has an elevated boiling point (Min. +315°). It avoids the "Vapor Lock" effect and allows a performing braking in case of elevated humidity. Its high chemical stability guarantees inalterability in the harshest thermic sollicitations. It can be used in vehicles and machineries of every brand and typology.

DOT 6 is ready to be used. It can be mixed with every brake fluid of the same typology.

IT CANNOT BE MIXED WITH SILICONE-BASED BRAKE FLUIDS OR WITH MINERAL FLUIDS (LHM).

Caratteristiche

Details

Aspetto / Aspect: Limpido / Limpid

Colore/Colour: Tipico / Usual

Peso specifico a 15°C: ASTM D 1298 1,010 – 1,090 Kg /dm³

Equilibrium Reflex Boiling Point: ASTM D 92 Min. 315 °C

Punto di ebollizione a umido / Boiling Point (wet E.R.B.P.): ASTM D 97 Min. 204 °C

Viscosità (mm²/s) a -40°C / Viscosity (mm²/s) at -40°C: 1800 mm²/s

Viscosità (mm²/s) a +100°C / Viscosity (mm²/s) at +100°C: 2,8 mm²/s

pH : 8 – 9

pH dopo corrosione / pH after corrosion: 7,2 – 8,2

Comportamento nei confronti dei particolari in gomma: Rigonfiamento Gomma SBR a 70 °C

Diminuzione durezza (IRHD) / Decreased hardness: 2,5

Aumento diametro (mm) / Increased diameter (mm): 0,6

Comportamento nei confronti dei particolari in gomma: Rigonfiamento Gomma SBR a 120 °C

Diminuzione durezza (IRHD) / Decreased hardness: 6



BRAKE/CLUTCH
MASTER CYLINDERS

ACCESSORIES
SPARE PARTS

CNC-WORKED FLUID
RESERVOIR

FULL CLUTCH

HYDRAULIC-CLUTCH
TRANFORMATION KIT

LEVER

THROTTLE CONTROL

BRAKE CALIPER

RACING KIT

BUTTON PANEL

LEVER GUARD

CLIP-ON

STREET RACING
REARSET

FUEL CAPS

STEERING NUT

CRASH PADS

PADDOCK STAND

MIRROR COVERS

REAR-VIEW MIRRORS





















FOG LIGHTS KIT

HANDLEBARS
ACCESSORIES

HANDLEBARS





Note: Si consiglia di rimuovere dall'impianto frenante dopo l'utilizzo in pista e sostituirlo con il fluido DOT4
Note: We recommend to remove from the brake system after using on track and replace it with DOT4 brake fluid

ACCESSORI ACCESSORIES

KITVG	Kit per il montaggio vaschetta Accossato (Vaschetta 30 ml - Tubo - Fascetta - Supporto in alluminio) / <i>Accossato fluid reservoir assembly kit (Fluid reservoir 30 ml - tube - hose clamp - aluminium support)</i>		AD002	Vite 2 fori + adattatore + 3 rondelle in rame <i>2-hole screw + adapter + 3 copper washers</i>	
KITVP	Kit per il montaggio vaschetta Accossato (Vaschetta 15 ml - Tubo - Fascetta - Supporto in alluminio) / <i>Accossato fluid reservoir assembly kit (Fluid reservoir 15 ml - tube - hose clamp - aluminium support)</i>		AD003	Adattatore <i>Adapter</i>	
VG001	Vaschetta 30 ml <i>Fluid reservoir 30 ml</i>		MH001	Supporto specchietto per pompe freno Accossato, ricavato CNC, filetto M8 / <i>Mirror holder for Accossato brake master cylinders, cnc-worked, screw pitch M8</i>	
VP001	Vaschetta 15 ml <i>Fluid reservoir 15 ml</i>		MH002	Supporto specchietto per pompe freno Accossato, ricavato CNC, filetto M10x1,25 / <i>Mirror holder for Accossato brake master cylinders, cnc-worked, screw pitch M10x1,25</i>	
ID001	Idrostop 1 foro, M10x1 (per pompa Accossato) <i>1-hole hydraulic switch, M10x1 (for Accossato master cylinder)</i>		MH003	Supporto specchietto per pompe frizione Accossato, ricavato CNC, filetto M8 / <i>Mirror holder for Accossato clutch master cylinders, cnc-worked, screw pitch M8</i>	
ID002	Idrostop 2 fori, M10x1 (per pompa Accossato) <i>2-hole hydraulic switch, M10x1 (for Accossato master cylinder)</i>		MH004	Supporto specchietto per pompe frizione Accossato, ricavato CNC, filetto M10x1,25 / <i>Mirror holder for Accossato clutch master cylinders, cnc-worked, screw pitch M10x1,25</i>	
ID003	Idrostop 1 foro, M10x1,25 <i>1-hole hydraulic switch, M10x1,25</i>		MH007	Supporto specchietto CNC per pompe freno Accossato, con vaschetta integrata, filetto M8 / <i>CNC-worked mirror holder for Accossato brake master cylinders with integrated fluid reservoir, screw pitch M8</i>	
ID004	Idrostop 2 fori, M10x1,25 <i>2-hole hydraulic switch, M10x1,25</i>		MH008	Supporto specchietto CNC per pompe freno Accossato, con vaschetta integrata, filetto M10x1,25 / <i>CNC-worked mirror holder for Accossato master cylinders with integrated fluid reservoir, screw pitch M10x1,25</i>	
ID005	Idrostop 1 foro, M10x1 a 90° (per pompa Accossato) <i>1-hole hydraulic switch, M10x1 at 90° (for Accossato master cylinder)</i>		MH009	Supporto specchietto CNC per pompe frizione Accossato, con vaschetta integrata, filetto M8 <i>CNC-worked mirror holder for Accossato clutch master cylinders with integrated fluid reservoir, screw pitch M8</i>	
AD001	Vite 1 foro + adattatore + 2 rondelle in rame <i>1-hole screw + adapter + 2 copper washers</i>		MH010	Supporto specchietto CNC per pompe frizione Accossato, con vaschetta integrata, filetto M10x1,25 / <i>CNC-worked mirror holder for Accossato clutch master cylinders with integrated fluid reservoir, screw pitch M10x1,25</i>	

- BRAKE/CLUTCH MASTER CYLINDERS
- ACCESSORIES SPARE PARTS
- CNC-WORKED FLUID RESERVOIR
- FULL CLUTCH
- HYDRAULIC-CLUTCH TRANSFORMATION KIT
- LEVER
- THROTTLE CONTROL
- BRAKE CALIPER
- RACING KIT
- BUTTON PANEL
- LEVER GUARD
- CLIP-ON
- STREET RACING REARSET
- FUEL CAPS
- STEERING NUT
- CRASH PADS
- PADDOCK STAND
- MIRROR COVERS
- REAR-VIEW MIRRORS
- FOG LIGHTS KIT
- HANDLEBARS ACCESSORIES
- HANDLEBARS

RICAMBI SPARE PARTS

RC006	Valvola di Spurgo corpi pompa M8x1 <i>Brake/clutch cylinder bleeding valve M8x1.00</i>		RC014	Cavallotto per pompa frizione Accossato con vaschetta integrata / Riser for Accossato clutch master cylinders with integrated fluid reservoir	
RC012	Valvola di spurgo pinza freno M8x1.25 <i>Caliper bleeding valve M8x1.25</i>		RC009	Pomello di regolazione + spina ø 1,5 <i>Span adjuster wheel + pin Ø 1,5</i>	
RC015	Valvola spurgo M8x1 (Pompa a pollice/pompa HRMC/pompa posteriore) <i>Cylinder bleeding valve (Thumb M.C /HRMC/ rear MC)</i>		RC007	Raccordo di compensazione olio a L <i>L-shaped fluid inlet for Accossato brake & clutch cylinders</i>	
MS2371	Valvola spurgo M10x1 (Pompa a pollice/pompa HRMC/pompa posteriore) <i>Cylinder bleeding valve (Thumb M.C /HRMC/ rear MC)</i>		RC005	Tappo in gomma per valvola di spurgo <i>Bleeding cover</i>	
MS2373	Valvola spurgo M10x1 con bullone doppio (Pompa a pollice/pompa HRMC/pompa posteriore) <i>Cylinder bleeding valve (Thumb M.C /HRMC/ rear MC)</i>		RC010	Guarnizione tenuta di compensazione olio <i>Fluid inlet seal</i>	
RC001	Cavallotto per pompa freno accossato linea racing, anodizzato naturale <i>Handlebar half clamp for Accossato Racing-line brake master cylinders</i>		RC046	Ricambio cuffia pompe freno-frizione <i>Brake-clutch master boot</i>	
RC002	Cavallotto per pompa frizione accossato linea racing, anodizzato naturale <i>Handlebar half clamp for Accossato Racing-line clutch master cylinders</i>		RC016	Ricambio fermaglio di sicurezza (per corpi pompa) <i>Pivot pin retaining clip</i>	
RC003	Cavallotto per pompa freno accossato black edition <i>Handlebar half clamp for Accossato Street Racing-line black -edition brake master cylinders</i>		RC017	Ricambio perno (per corpi pompa) <i>Pivot pin</i>	
RC004	Cavallotto per pompa frizione accossato black edition, linea street racing, nero <i>Handlebar half clamp for Accossato Street Racing-line black -edition clutch master cylinders</i>		RC018	Ricambio perno prs freno (per corpi pompa) <i>Pivot pin for PRS cylinders</i>	
RC013	Cavallotto per pompa freno Accossato con vaschetta integrata / Riser for Accossato brake master cylinders with integrated fluid reservoir		RC019	Ricambio boccola (per corpi pompa) <i>Bushing for PRS cylinders</i>	

BRAKE/CLUTCH
MASTER CYLINDERS
 ACCESSORIES
SPARE PARTS
 CNC-WORKED FLUID
RESERVOIR
 FULL CLUTCH
 HYDRAULIC-CLUTCH
TRANFORMATION KIT
 LEVER
 THROTTLE CONTROL
 BRAKE CALIPER
 RACING KIT
 BUTTON PANEL
 LEVER GUARD
 CLIP-ON
 STREET RACING
REARSET
 FUEL CAPS
 STEERING NUT
 CRASH PADS
 PADDOCK STAND
 MIRROR COVERS
 REAR-VIEW MIRRORS
 FOG LIGHTS KIT
 HANDLEBARS
ACCESSORIES
 HANDLEBARS

RC022	Portagrano leva radiale Grain carrier radial lever		RC053	Guarnizione di compensazione vaschetta frizione Clutch reservoir inlet seal	
RC011	(N° 2) viti cavallotto, m6x20 (2 pcs) handlebar half clamp bolts, M6x20		RC025	Sottotappo serbatoio freno Seal Cap For Integrate Reservoir of Brake Master Cylinder	
RC043	Staffa fissaggio vaschetta freno Bracket brake fluid reservoir		RC029	Guarnizione tenuta di compensazione olio Fluid inlet seal	
RC044	Staffa fissaggio vaschetta frizione Bracket clutch fluid reservoir		RC042	Tubo gomma metro Rubber hose meter	
RC020	Ricambio coperchio pompa freno (pompe off road) e pompa posteriore con vaschetta integrata Reservoir cover for off road brake cylinders and rear brake master cylinder with integrated fluid reservoir		TU001	Tubo in gomma Rubber tube	
RC021	Ricambio guarnizione vaschetta (pompe off road) e pompa posteriore con vaschetta integrata Reservoir gasket for off road brake cylinders and rear brake master cylinder with integrated fluid reservoir		FA001	Fascetta Hose clamp	
RC047	Ricambio coperchio pompa frizione (Pompe vaschetta integrata) Reservoir cover for clutch M.C (Reservoir integrated)		ROND10	Rondella in rame Copper washer	
RC048	Ricambio coperchio pompa freno (Pompe vaschetta integrata) / Reservoir cover for brake M.C (Reservoir integrated)		MS2362	Bullone doppio Double bolt Diam. M10x1	
RC052	Guarnizione di compensazione vaschetta freno Brake reservoir inlet seal		MS2363	Bullone doppio Double bolt Diam. M10x1,25	
RC023	Sottotappo serbatoio freno Seal Cap For Integrate Reservoir of Brake Master Cylinder		MS2364	Bullone doppio Double bolt Diam. 3/8"	

BRAKE/CLUTCH
 MASTER CYLINDERS
 ACCESSORIES
 SPARE PARTS
 CNC-WORKED FLUID
 RESERVOIR
 FULL CLUTCH
 HYDRAULIC-CLUTCH
 TRANSFORMATION KIT
 LEVER
 THROTTLE CONTROL
 BRAKE CALIPER
 RACING KIT
 BUTTON PANEL
 LEVER GUARD
 CLIP-ON
 STREET RACING
 REARSET
 FUEL CAPS
 STEERING NUT
 CRASH PADS
 PADDOCK STAND
 MIRROR COVERS
 REAR-VIEW MIRRORS
 FOG LIGHTS KIT
 HANDLEBARS
 ACCESSORIES
 HANDLEBARS

MS2365	Bullone singolo / Single bolt Diam. M10x1		BS006	Staffa di supporto pompa HRMC Bracket for HRMC M.C	
MS2366	Bullone singolo / single bolt Diam. M10x1,25		RC051	Cavallotto comando frizione Clutch control handlebar half clamp	
MS2367	Bullone singolo / single bolt Diam. 3/8"		MI001	Micro Switch Per Comando Frizione Accossato Switch For Accossato Full Clutch	
IN001	Inserto leva revolution + viti Insert revolution lever + screw		RC055	Cuffia in gomma di ricambio / Spare rubber cap	
IN003	Codino leva revolution Final insert revolution lever		RC056	Guarnizione tappo serbatoio Spare fuel cap rubber seal	
BS001	Leva corta pompa a pollice Short lever for thumb master cylinder				
BS002	Leva lunga pompa a pollice Long lever for thumb master cylinder				
BS003	Leva curva pompa a pollice Bent lever for thumb master cylinder				
BS004	Staffa di supporto / Bracket				
BS005	Leva HRMC / Lever HRMC				

BRAKE/CLUTCH
MASTER CYLINDERS
 ACCESSORIES
SPARE PARTS
 CNC-WORKED FLUID
RESERVOIR
 FULL CLUTCH
 HYDRAULIC-CLUTCH
TRANFORMATION KIT
 LEVER
 THROTTLE CONTROL
 BRAKE CALIPER
 RACING KIT
 BUTTON PANEL
 LEVER GUARD
 CLIP-ON
 STREET RACING
REARSET
 FUEL CAPS
 STEERING NUT
 CRASH PADS
 PADDOCK STAND
 MIRROR COVERS
 REAR-VIEW MIRRORS
 FOG LIGHTS KIT
 HANDLEBARS
ACCESSORIES
 HANDLEBARS

POLSINO PROTEZIONE OLIO

ACCOSSATO DESIGN OIL TANK PROTECTION



Codice
Reference

Descrizione
Description

AB033

Polsino spugna / *Sponge wristband*
Protezione serbatoio olio accossato design / *Accossato design oil tank protection*

- BRAKE/CLUTCH MASTER CYLINDERS
- ACCESSORIES SPARE PARTS
- CNC-WORKED FLUID RESERVOIR
- FULL CLUTCH
- HYDRAULIC-CLUTCH TRANSFORMATION KIT
- LEVER
- THROTTLE CONTROL
- BRAKE CALIPER
- RACING KIT
- BUTTON PANEL
- LEVER GUARD
- CLIP-ON
- STREET RACING REARSET
- FUEL CAPS
- STEERING NUT
- CRASH PADS
- Paddock STAND
- MIRROR COVERS
- REAR-VIEW MIRRORS
- FOG LIGHTS KIT
- HANDLEBARS ACCESSORIES
- HANDLEBARS

SERBATOIO OLIO CNC-FRENO

CNC-WORKED FLUID RESERVOIR - BRAKE

Codice Reference	Descrizione Description
FU010	Serbatoio olio freno CNC 25 cm ³ con uscita olio orizzontale CNC-worked brake fluid reservoir 25 cm ³ with horizontal oil spill
FU104	Serbatoio olio freno CNC 25 cm ³ con uscita olio verticale CNC-worked brake fluid reservoir 25 cm ³ with vertical oil spill

Combinazione colori tra tappo e serbatoio ordinabile sul B2B
Color combination of cap and reservoir can be orderable on B2B



Accessori / Accessories

Codice Reference	Descrizione Description
FS002	Staffa di fissaggio dritta (fornita di serie) Straight bracket (standard equipment)
FS003	Staffa di fissaggio 90° 90° bracket
FS004	Staffa di fissaggio specifica per montaggio su pompe freno Accossato Bracket specific for mounting Accossato brake master cylinders

Colore tappo / Cap color

N ● nero - black
 O ● arancione - orange
 Y ● oro - gold
 B ● blu - blue
 R ● rosso - red
 S ● argento - silver
 G ● verde - green

Colore serbatoio / Reservoir color

N ● nero - black
 O ● arancione - orange
 Y ● oro - gold
 B ● blu - blue
 R ● rosso - red
 S ● argento - silver
 G ● verde - green

- BRAKE/CLUTCH MASTER CYLINDERS
- ACCESSORIES SPARE PARTS
- CNC-WORKED FLUID RESERVOIR
- FULL CLUTCH
- HYDRAULIC-CLUTCH TRANSFORMATION KIT
- LEVER
- THROTTLE CONTROL
- BRAKE CALIPER
- RACING KIT
- BUTTON PANEL
- LEVER GUARD
- CLIP-ON
- STREET RACING REARSET
- FUEL CAPS
- STEERING NUT
- CRASH PADS
- Paddock STAND
- MIRROR COVERS
- REAR-VIEW MIRRORS
- FOG LIGHTS KIT
- HANDLEBARS ACCESSORIES
- HANDLEBARS

SERBATOIO OLIO CNC-FRIZIONE

CNC-WORKED FLUID RESERVOIR - CLUTCH

Codice Reference	Descrizione Description
FU057	Serbatoio olio frizione CNC 15 cm ³ con uscita olio orizzontale CNC-worked brake fluid reservoir 15 cm ³ with horizontal oil spill
FU151	Serbatoio olio frizione CNC 15 cm ³ con uscita olio verticale CNC-worked brake fluid reservoir 15 cm ³ with vertical oil spill

Combinazione colori tra tappo e serbatoio ordinabile sul B2B
Color combination of cap and reservoir can be ordinable on B2B



Accessori / Accessories

Codice Reference	Descrizione Description
FS002	Staffa di fissaggio dritta (fornita di serie) Straight bracket (standard equipment)
FS003	Staffa di fissaggio 90° 90° bracket
FS005	Staffa di fissaggio specifica per montaggio su pompe frizione Accossato Bracket specific for mounting Accossato clutch master cylinders

Colore tappo / Cap color



Colore serbatoio / Reservoir color



- BRAKE/CLUTCH MASTER CYLINDERS
- ACCESSORIES SPARE PARTS
- CNC-WORKED FLUID RESERVOIR
- FULL CLUTCH
- HYDRAULIC-CLUTCH TRANSFORMATION KIT
- LEVER
- THROTTLE CONTROL
- BRAKE CALIPER
- RACING KIT
- BUTTON PANEL
- LEVER GUARD
- CLIP-ON
- STREET RACING REARSET
- FUEL CAPS
- STEERING NUT
- CRASH PADS
- Paddock STAND
- MIRROR COVERS
- REAR-VIEW MIRRORS
- FOG LIGHTS KIT
- HANDLEBARS ACCESSORIES
- HANDLEBARS

VASCHE TTE OLIO CNC FRENO/FRIZIONE

BRAKE & CLUTCH CNC-WORKED FLUID RESERVOIRS



Codice
Reference

Descrizione
Description

FU152

Vaschetta olio Accossato dal design "see-through"
Accossato "see-through" fluid reservoir

Specifiche tecniche
Technical specifications

Volume / Capacity: 20 cm³
Raccordi uscita verticale o orizzontale inclusi / Provided with vertical & horizontal output fittings
Staffa di montaggio non inclusa / Mounting bracket not included

Colori / Colours

N ●
nero - black

O ●
arancione
orange

Y ●
oro - gold

B ●
blu - blue

R ●
rosso - red

S ●
argento - silver

G ●
verde - green

BRAKE/CLUTCH
MASTER CYLINDERS

ACCESSORIES
SPARE PARTS

CNC-WORKED FLUID
RESERVOIR

FULL CLUTCH

HYDRAULIC-CLUTCH
TRANFORMATION KIT

LEVER

THROTTLE CONTROL

BRAKE CALIPER

RACING KIT

BUTTON PANEL

LEVER GUARD

CLIP-ON

STREET RACING
REARSET

FUEL CAPS

STEERING NUT

CRASH PADS

PADOCK STAND

MIRROR COVERS

REAR-VIEW MIRRORS

FOG LIGHTS KIT

HANDLEBARS
ACCESSORIES

HANDLEBARS

VASCHEFFE OLIO TRASPARENTI FRENO/FRIZIONE

BRAKE & CLUTCH TRANSPARENT FLUID RESERVOIRS



Codici vaschetta fumè Carachoal reservoir code	Codici vaschetta trasparente Transparent reservoir code	Descrizione Description
VG002	VG003	Vaschetta 45 ml Fluid reservoir 45 ml
VP002	VP003	Vaschetta 15 ml Fluid reservoir 15 ml
KITVG02	KITVG03	Kit per il montaggio vaschetta Accossato (Vaschetta 45 ml - Tubo - Fascetta - Supporto in alluminio) Accossato fluid reservoir assembly kit (Fluid reservoir 45 ml - tube - hose clamp - aluminium support)
KITVP02	KITVP03	Kit per il montaggio vaschetta Accossato (Vaschetta 15 ml - Tubo - Fascetta - Supporto in alluminio) Accossato fluid reservoir assembly kit (Fluid reservoir 15 ml - tube - hose clamp - aluminium support)

BRAKE/CLUTCH
MASTER CYLINDERS
ACCESSORIES
SPARE PARTS
CNC-WORKED FLUID
RESERVOIR
FULL CLUTCH
HYDRAULIC-CLUTCH
TRANSFORMATION KIT
LEVER
THROTTLE CONTROL
BRAKE CALIPER
RACING KIT
BUTTON PANEL
LEVER GUARD
CLIP-ON
STREET RACING
REARSET
FUEL CAPS
STEERING NUT
CRASH PADS
PADDOCK STAND
MIRROR COVERS
REAR-VIEW MIRRORS
FOG LIGHTS KIT
HANDLEBARS
ACCESSORIES
HANDLEBARS

Comando frizione a cavo







Full clutch



Codice Reference	Descrizione Description
CF001	Comando frizione leva snodata / full clutch with folding lever
CF002	Comando frizione con attacco micro (micro non incluso) / provided with switch setup (switch not included)
CF003	Comando frizione con braccialetto in colore titanio / with hose clamp in titanium colour
CF004	Comando frizione con micro incluso / with switch included
CF005	Comando frizione con micro e supporto specchietto inclusi / with switch and mirror holder included

Interassi disponibili Available distances	Opzioni leva Lever options
24 mm - 29 mm - 32 mm - 34 mm	RST

Colori* / Colours*

N 	O 	Y 	B 	R 	S 	G 	T 
nero - black	arancione orange	oro - gold	blu - blue	rosso - red	argento - silver	verde - green	titanio - titanium

* Perno di regolazione ed impugnatura: stesso colore / Adjusting knob & handle: same color
Tutte le leve hanno lunghezza standard / all standard-length levers

- BRAKE/CLUTCH MASTER CYLINDERS
- ACCESSORIES SPARE PARTS
- CNC-WORKED FLUID RESERVOIR
- FULL CLUTCH
- HYDRAULIC-CLUTCH TRANSFORMATION KIT
- LEVER
- THROTTLE CONTROL
- BRAKE CALIPER
- RACING KIT
- BUTTON PANEL
- LEVER GUARD
- CLIP-ON
- STREET RACING REARSET
- FUEL CAPS
- STEERING NUT
- CRASH PADS
- PADDOCK STAND
- MIRROR COVERS
- REAR-VIEW MIRRORS
- FOG LIGHTS KIT
- HANDLEBARS ACCESSORIES
- HANDLEBARS

Comando frizione a cavo "revolution"

"Revolution" full clutch



Codice Reference	Descrizione Description
CF011	Comando frizione revolution / <i>Revolution full clutch with folding lever</i>
CF012	Comando frizione con attacco micro (micro non incluso) / <i>Provided with switch setup (switch not included)</i>
CF013	Comando frizione con bracciale in colore titanio / <i>With hose clamp in titanium colour</i>
CF014	Comando frizione con micro incluso / <i>With switch included</i>
CF015	Comando frizione con micro e supporto specchietto inclusi / <i>With switch and mirror holder included</i>

Interassi disponibili

Available distances

24 mm - 29 mm - 32 mm - 34 mm

■ Inerti di ricambio / *spare-part insets*

Codice Reference	Descrizione Description
IN001	Inserito + viti / <i>Insert + screws</i>
IN003	Codino / <i>Ending</i>

Note/Notes: Perno di regolazione e codino: stesso colore / *Adjusting knob & ending: same color*

Colori* / *Colours**

N ●	O ●	Y ●	B ●	R ●	S ●	G ●
nero - black	arancione orange	oro - gold	blu - blue	rosso - red	argento - silver	verde - green

- BRAKE/CLUTCH MASTER CYLINDERS
- ACCESSORIES SPARE PARTS
- CNC-WORKED FLUID RESERVOIR
- FULL CLUTCH
- HYDRAULIC-CLUTCH TRANSFORMATION KIT
- LEVER
- THROTTLE CONTROL
- BRAKE CALIPER
- RACING KIT
- BUTTON PANEL
- LEVER GUARD
- CLIP-ON
- STREET RACING REARSET
- FUEL CAPS
- STEERING NUT
- CRASH PADS
- PADOCK STAND
- MIRROR COVERS
- REAR-VIEW MIRRORS
- FOG LIGHTS KIT
- HANDLEBARS ACCESSORIES
- HANDLEBARS

Comando frizione a cavo "racing"

"Racing" full clutch



Codice Reference	Descrizione Description
CF006	Comando frizione leva snodata full clutch / Full clutch control with folding lever
CF007	Comando frizione con attacco micro (micro non incluso) / Provided with switch setup (switch not included)
CF008	Comando frizione con bracciale in colore titanio / With hose clamp in titanium colour
CF009	Comando frizione con micro incluso / With switch included
CF010	Comando frizione con micro e supporto specchietto inclusi / With switch and mirror holder included

Interassi disponibili Available distances

24 mm - 29 mm - 32 mm - 34 mm

Opzioni leva Lever option

RST

Colori / Colours

N ●	O ●	Y ●	B ●	R ●	S ●	G ●	T ●
nero - black	arancione orange	oro - gold	blu - blue	rosso - red	argento - silver	verde - green	titanio - titanium

* Perno di regolazione ed impugnatura: stesso colore / Adjusting knob & handle: same color

Accessori / Spare parts

Codice Reference	Descrizione Description
MH005	Supporto specchietto ricavato CNC, filetto M8, per comandi frizione Accossato: CF001 - CF015 CNC-worked mirror holder, M8 screw pitch, suitable for full clutches: CF001 - CF015
MH006	Supporto specchietto ricavato CNC, filetto M10x1,25 per comandi frizione Accossato: CF001 - CF015 CNC-worked mirror holder, M10x1,25 screw pitch, suitable for full clutches: CF001 - CF015

BRAKE/CLUTCH
MASTER CYLINDERS
ACCESSORIES
SPARE PARTS
CNC-WORKED FLUID
RESERVOIR
FULL CLUTCH
HYDRAULIC-CLUTCH
TRANSFORMATION KIT
LEVER
THROTTLE CONTROL
BRAKE CALIPER
RACING KIT
BUTTON PANEL
LEVER GUARD
CLIP-ON
STREET RACING
REARSET
FUEL CAPS
STEERING NUT
CRASH PADS
PADDOCK STAND
MIRROR COVERS
REAR-VIEW MIRRORS
FOG LIGHTS KIT
HANDLEBARS
ACCESSORIES
HANDLEBARS

Comando frizione off road

Off-road clutch control



Codice Reference	Descrizione Description
CF016	Comando frizione cross universale Universal cross clutch control

Interassi disponibili
Available distances

24 mm - 29 mm - 32 mm

Colori / Colours

N 
nero - black

O 
arancione
orange

Y 
oro - gold

B 
blu - blue

R 
rosso - red

S 
argento - silver

G 
verde - green

- BRAKE/CLUTCH MASTER CYLINDERS
- ACCESSORIES SPARE PARTS
- CNC-WORKED FLUID RESERVOIR
- FULL CLUTCH
- HYDRAULIC-CLUTCH TRANSFORMATION KIT
- LEVER
- THROTTLE CONTROL
- BRAKE CALIPER
- RACING KIT
- BUTTON PANEL
- LEVER GUARD
- CLIP-ON
- STREET RACING REARSET
- FUEL CAPS
- STEERING NUT
- CRASH PADS
- PADDOCK STAND
- MIRROR COVERS
- REAR-VIEW MIRRORS
- FOG LIGHTS KIT
- HANDLEBARS ACCESSORIES
- HANDLEBARS

Comando frizione Moto3

Moto3 clutch control



Codice Reference	Descrizione Description
CF017	Comando frizione Moto3 Moto3 clutch control

Interassi disponibili Available distances

24 mm - 29 mm - 32 mm

Colori / Colours

N ●
nero - black

O ●
arancione
orange

Y ●
oro - gold

B ●
blu - blue

R ●
rosso - red

S ●
argento - silver

G ●
verde - green

BRAKE/CLUTCH
MASTER CYLINDERS

ACCESSORIES
SPARE PARTS

CNC-WORKED FLUID
RESERVOIR

FULL CLUTCH

HYDRAULIC-CLUTCH
TRANSFORMATION KIT

LEVER

THROTTLE CONTROL

BRAKE CALIPER

RACING KIT

BUTTON PANEL

LEVER GUARD

CLIP-ON

STREET RACING
REARSET

FUEL CAPS

STEERING NUT

CRASH PADS

Paddock STAND

MIRROR COVERS

REAR-VIEW MIRRORS

FOG LIGHTS KIT

HANDLEBARS
ACCESSORIES

HANDLEBARS

Kit di trasformazione frizione filo-idraulica

Hydraulic-clutch transformation kit



■ Kit di trasformazione frizione filo - idraulica / Hydraulic - Clutch transformation kit

Applicazioni / Application list

Marca Brand	Cc	Modello Model	Anno dal From	Anno al To	Codice Code	Novità New	Marca Brand	Cc	Modello Model	Anno dal From	Anno al To	Codice Code	Novità New
APRILIA	250	RS 250	1995	2006	HS002		SUZUKI	600	GSX-R	2002	2005	HS002	
BMW	650	F 650 GS	2008	2012	HS005	N	SUZUKI	600	GSR	2005	2006	HS038	
BMW	700	F 700 GS	2006	2015	HS005	N	SUZUKI	600	GSX-R	2006	2008	HS037	
BMW	800	F 800 S	ALL MODELS		HS005		SUZUKI	600	GSR	2007	2007	HS039	
BMW	800	F 800 GS	ALL MODELS		HS006		SUZUKI	650	GSX-F	1998	2006	HS033	N
BMW	800	F 800 GT	2006	2015	HS005	N	SUZUKI	650	SV NAKED	2000	2001	HS047	
BMW	800	F 800 R	2006	2015	HS005	N	SUZUKI	650	SV NAKED	2002	2006	HS002	
BMW	800	F 800 ST	2006	2015	HS005	N	SUZUKI	650	SV 650	1999	2010	HS006	N
BMW	800	F800 MODELLE	2006	2015	HS005	N	SUZUKI	750	GSX-F	1998	2006	HS033	
BOMBARDIER	650	DS 650 ATV	2004	2009	HS006	N	SUZUKI	750	GSX-R	2000	2003	HS033	
GUZZI	350	V35	1977	1987	HS009		SUZUKI	750	GSX-R	2006	2008	HS037	
HARLEY DAVIDSON	883	SPORTSTER	1996	2016	HS048	N	SUZUKI	1000	GSX-R	2003	2004	HS005	
HARLEY DAVIDSON	1200	SPORTSTER	1996	2016	HS048	N	SUZUKI	1000	GSX-R	2005	2006	HS002	
HONDA	600	CBF	2004	2005	HS017		SUZUKI	1000	GSX-S 1000	2015	2017	HS006	N
HONDA	600	CBF	2006	2006	HS002		SUZUKI	1100	GSX-R	1985	1990	HS041	
HONDA	600	CBF 600 (PC43)	2008	2014	HS006	N	TRIUMPH	900	SPEEDTRIPLE	2005	2007	HS017	
HONDA	600	CBF 600 S/N (PC38)	2004	2007	HS006	N	TRIUMPH	1050	TIGER	2004	2004	HS047	
HONDA	700	NC 700 S	2012	2014	HS006	N	TRIUMPH	1050	SPEEDTRIPLE	2005	2007	HS017	
HONDA	700	NC 700 X	2012	2014	HS006	N	TRIUMPH	1050	TIGER	2006	2006	HS017	
HONDA	750	AFRICA TWIN RD	1991	1991	HS019	N	TRIUMPH	1050	SPEED TRIPLE 1050	2011	2015	HS006	N
HONDA	750	AFRICA TWIN	1997	1997	HS020	N	YAMAHA	400	SR 400	2014	2016	HS008	N
HONDA	750	NC 750 S	2015	2018	HS006	N	YAMAHA	500	SR 500	ALL MODELS		HS008	N
HONDA	750	NC 750 X	2015	2018	HS006	N	YAMAHA	600	FZ6 / FAZER	2004	2006	HS018	
HONDA	1000	CRF 1000 L	2016	2018	HS006	N	YAMAHA	600	FZ6	2007	2010	HS006	N
HUSQVARNA	900	NUDA	2012	2014	HS005	N	YAMAHA	660	MT-03	2006	2006	HS044	
KAWASAKI	636	ZX-6R	2005	2006	HS002		YAMAHA	660	XT 660 X	2004	2011	HS017	
KAWASAKI	750	Z 750	2005	2006	HS017		YAMAHA	660	XT 660 R	2004	2011	HS017	N
KAWASAKI	750	Z 750 S	2005	2006	HS017	N	YAMAHA	900	TDM	2002	2010	HS038	
KAWASAKI	750	Z 750	2007	2010	HS029		YAMAHA	1000	YZF-R1	1998	2001	HS045	
KAWASAKI	1000	Z 1000	2003	2018	HS031		YAMAHA	1000	FAZER	2001	2005	HS017	
							YAMAHA	1000	FZ1	2006	2009	HS045	

■ Ricambio attuatore / Spare parts actuator

Codice Reference	Descrizione Description
AT001	Ricambio solo attuatore / Spare parts only actuator



BRAKE/CLUTCH
MASTER CYLINDERS
 ACCESSORIES
SPARE PARTS
 CNC-WORKED FLUID
RESERVOIR
 FULL CLUTCH
 HYDRAULIC-CLUTCH
TRANFORMATION KIT
 LEVER
 THROTTLE CONTROL
 BRAKE CALIPER
 RACING KIT
 BUTTON PANEL
 LEVER GUARD
 CLIP-ON
 STREET RACING
REARSET
 FUEL CAPS
 STEERING NUT
 CRASH PADS
 PADDOCK STAND
 MIRROR COVERS
 REAR-VIEW MIRRORS
 FOG LIGHTS KIT
 HANDLEBARS
ACCESSORIES
 HANDLEBARS

LEVE SNODATE: RICAMBIO PER COMANDI FRIZIONE

FOLDING LEVERS: SPARE PARTS FOR FULL CLUTCHES



LV016

- BRAKE/CLUTCH MASTER CYLINDERS
- ACCESSORIES SPARE PARTS
- CNC-WORKED FLUID RESERVOIR
- FULL CLUTCH
- HYDRAULIC-CLUTCH TRANSFORMATION KIT
- LEVER
- THROTTLE CONTROL
- BRAKE CALIPER
- RACING KIT
- BUTTON PANEL
- LEVER GUARD
- CLIP-ON
- STREET RACING REARSET
- FUEL CAPS
- STEERING NUT
- CRASH PADS
- PADDOCK STAND
- MIRROR COVERS
- REAR-VIEW MIRRORS
- FOG LIGHTS KIT
- HANDLEBARS ACCESSORIES
- HANDLEBARS



LV017

Codice Reference	Descrizione Description
LV016	Ricambio leva per comando frizione CF001 - CF005 / Spare lever for clutch control CF001 - CF005
LV017	Ricambio leva per comando frizione CF006 - CF010 / Spare lever for clutch control CF006 - CF010
LV031	Ricambio leva per comando frizione CF016 - CF017 / Spare lever for clutch control CF016 - CF017 New

Interassi disponibili
Available distances

Opzioni
Options

24 mm - 29 mm - 32 mm - 34 mm

RST

Tutte le leve hanno lunghezza standard / All standard-length levers

Codice Reference	Descrizione Description
LV028	Ricambio solo impugnatura per comando frizione CF001-CF006 / Only spare handle for clutch control CF001-CF006
LV029	Ricambio solo impugnatura per comando frizione CF006 - CF010 / Only spare handle for clutch control CF006-CF010
LV032	Ricambio solo impugnatura per comando frizione CF016 - CF017 / Only spare handle for clutch control CF016-CF017 New

Colori impugnatura / Handle colours

N 
nero - black

O 
arancione
orange

Y 
oro - gold

B 
blu - blue

R 
rosso - red

S 
argento - silver

G 
verde - green

T 
titanio - titanium

BRAKE/CLUTCH
MASTER CYLINDERS
 ACCESSORIES
SPARE PARTS
 CNC-WORKED FLUID
RESERVOIR
 FULL CLUTCH
 HYDRAULIC-CLUTCH
TRANSFORMATION KIT
 LEVER
 THROTTLE CONTROL
 BRAKE CALIPER
 RACING KIT
 BUTTON PANEL
 LEVER GUARD
 CLIP-ON
 STREET RACING
REARSET
 FUEL CAPS
 STEERING NUT
 CRASH PADS
 PADDOCK STAND
 MIRROR COVERS
 REAR-VIEW MIRRORS
 FOG LIGHTS KIT
 HANDLEBARS
ACCESSORIES
 HANDLEBARS

LEVA SNODATA CON IMPUGNATURA “REVOLUTION”: FOLDING LEVER WITH “REVOLUTION” HANDLE:



Codice Reference	Descrizione Description
LV025	Ricambio leva per comando frizione CF011 - CF015 con impugnatura revolution / "Revolution-handle" clutch lever for clutch control CF011 - CF015 RST di serie / RST equipped

Interassi disponibili Available distances

24 mm - 29 mm - 32 mm - 34 mm

Codice Reference	Descrizione Description
IN001	Inserto + viti / Insert +screws
IN003	Codino / Ending

Colori / Colours

N 
nero - black

O 
arancione
orange

Y 
oro - gold

B 
blu - blue

R 
rosso - red

S 
argento - silver

G 
verde - green

BRAKE/CLUTCH
MASTER CYLINDERS
 ACCESSORIES
SPARE PARTS
 CNC-WORKED FLUID
RESERVOIR
 FULL CLUTCH
 HYDRAULIC-CLUTCH
TRANSFORMATION KIT
 LEVER
 THROTTLE CONTROL
 BRAKE CALIPER
 RACING KIT
 BUTTON PANEL
 LEVER GUARD
 CLIP-ON
 STREET RACING
REARSET
 FUEL CAPS
 STEERING NUT
 CRASH PADS
 PADDOCK STAND
 MIRROR COVERS
 REAR-VIEW MIRRORS
 FOG LIGHTS KIT
 HANDLEBARS
ACCESSORIES
 HANDLEBARS

LEVE FISSE: RICAMBIO PER POMPE FRENO/FRIZIONE

FIX LEVERS: SPARE PARTS FOR BRAKE/CLUTCH MASTER CYLINDERS



Codice Reference	Descrizione Description
LV001	Leva freno fissa, per pompe radiali Accossato e Brembo / Fix brake lever, for Accossato and Brembo radial master cylinders RST di serie / RST equipped
LV002	Leva frizione fissa, per pompe radiali Accossato e Brembo / Fix clutch lever, for Accossato and Brembo radial master cylinders RST di serie / RST equipped

Interassi disponibili Available distances

LV001	16 mm - 18 mm - 19 mm - 20 mm
LV002	16 mm - 18 mm - 20 mm

Colori impugnatura / Handle colours

N 
nero - black

O 
arancione
orange

Y 
oro - gold

B 
blu - blue

R 
rosso - red

S 
argento - silver

G 
verde - green

Opzioni leva Lever options

Lunga / long: 17cm

Corta/Short: 15cm

BRAKE/CLUTCH
MASTER CYLINDERS
 ACCESSORIES
SPARE PARTS
 CNC-WORKED FLUID
RESERVOIR
 FULL CLUTCH
 HYDRAULIC-CLUTCH
TRANSFORMATION KIT
 LEVER
 THROTTLE CONTROL
 BRAKE CALIPER
 RACING KIT
 BUTTON PANEL
 LEVER GUARD
 CLIP-ON
 STREET RACING
REARSET
 FUEL CAPS
 STEERING NUT
 CRASH PADS
 PADDOCK STAND
 MIRROR COVERS
 REAR-VIEW MIRRORS
 FOG LIGHTS KIT
 HANDLEBARS
ACCESSORIES
 HANDLEBARS

LEVE SNODATE: RICAMBIO PER POMPE FRENO "READY TO BRAKE" FOLDING LEVERS: SPARE PARTS FOR BRAKE "READY TO BRAKE" MASTER CYLINDERS



Codice Reference	Descrizione Description
LV030	Leva freno radiale snodata per pompe freno "Ready to brake" / Folding radial brake lever, for "Ready to brake" master cylinders RST di serie / RST equipped

Interassi disponibili Available distances

LV030	18 mm - 19 mm - 20 mm - PRS (17-18-19 mm)
-------	---

Colori impugnatura / Handle colours

N ●
nero - black

O ●
arancione
orange

Y ●
oro - gold

B ●
blu - blue

R ●
rosso - red

S ●
argento - silver

G ●
verde - green

Opzioni leva Lever options

Lunga / long: 17cm

Corta/Short: 15cm

BRAKE/CLUTCH
MASTER CYLINDERS
 ACCESSORIES
SPARE PARTS
 CNC-WORKED FLUID
RESERVOIR
 FULL CLUTCH
 HYDRAULIC-CLUTCH
TRANSFORMATION KIT
 LEVER
 THROTTLE CONTROL
 BRAKE CALIPER
 RACING KIT
 BUTTON PANEL
 LEVER GUARD
 CLIP-ON
 STREET RACING
REARSET
 FUEL CAPS
 STEERING NUT
 CRASH PADS
 PADDOCK STAND
 MIRROR COVERS
 REAR-VIEW MIRRORS
 FOG LIGHTS KIT
 HANDLEBARS
ACCESSORIES
 HANDLEBARS

LEVA SNODATA CON IMPUGNATURA “REVOLUTION”

FOLDING LEVER WITH “REVOLUTION” HANDLE



Codice Reference	Descrizione Description
LV003	Leva freno con impugnatura Revolution, per pompe radiali Accossato e Brembo “Revolution-handle” brake lever, for Accossato and Brembo radial master cylinders RST di serie / RST equipped
LV004	Leva Frizione con impugnatura Revolution, per Pompe radiali Accossato e Brembo “Revolution-handle” clutch lever, for Accossato and Brembo radial master cylinders RST di serie / RST equipped
Interassi disponibili Available distances	
LV003	16 mm - 18 mm - 19 mm - 20 mm - PRS (17-18-19 mm)
LV004	16 mm - 18 mm - PRS (15-16-17 mm)

- BRAKE/CLUTCH MASTER CYLINDERS
- ACCESSORIES SPARE PARTS
- CNC-WORKED FLUID RESERVOIR
- FULL CLUTCH
- HYDRAULIC-CLUTCH TRANSFORMATION KIT
- LEVER
- THROTTLE CONTROL
- BRAKE CALIPER
- RACING KIT
- BUTTON PANEL
- LEVER GUARD
- CLIP-ON
- STREET RACING REARSET
- FUEL CAPS
- STEERING NUT
- CRASH PADS
- PADDOCK STAND
- MIRROR COVERS
- REAR-VIEW MIRRORS
- FOG LIGHTS KIT
- HANDLEBARS ACCESSORIES
- HANDLEBARS

LEVE SNODATE: RICAMBIO PER POMPE FRENO/FRIZIONE

FOLDING LEVERS: SPARE PARTS FOR BRAKE/CLUTCH MASTER CYLINDERS



LV005



LV023

Codice Reference	Descrizione Description
LV005	Leva freno radiale snodata per pompe freno Accossato e Brembo Folding radial brake lever for Accossato and Brembo brake master cylinders
LV006	Leva frizione radiale snodata per pompe frizione Accossato e Brembo Folding radial clutch lever for Accossato and Brembo clutch master cylinders
LV023	Leva di ricambio per pompa freno Accossato off road, codice CY010 Radial lever, spare part for Accossato off road brake master cylinder, code CY010

Interassi disponibili Available distances

LV005	16 mm - 18 mm - 19 mm - 20 mm - 21 mm - PRS (17-18-19 mm)
LV006	16 mm - 18 mm - 20 mm - PRS (15-16-17 mm)

Opzioni leva Lever options

Lunga / long: 17cm
Corta/Short: 15cm

Codice Reference	Descrizione Description
LV026	Ricambio solo impugnatura freno radiale snodata per pompe freno Accossato e Brembo Only spare handle folding radial brake for Accossato and Brembo brake master cylinder
LV027	Ricambio solo impugnatura frizione radiale snodata per pompe frizioni Accossato e Brembo Only spare handle folding radial clutch for Accossato and Brembo clutch master cylinder

Colori impugnatura / Handle colours

N 
nero - black

O 
arancione
orange

Y 
oro - gold

B 
blu - blue

R 
rosso - red

S 
argento - silver

G 
verde - green

BRAKE/CLUTCH
MASTER CYLINDERS
ACCESSORIES
SPARE PARTS
CNC-WORKED FLUID
RESERVOIR
FULL CLUTCH
HYDRAULIC-CLUTCH
TRANSFORMATION KIT
LEVER
THROTTLE CONTROL
BRAKE CALIPER
RACING KIT
BUTTON PANEL
LEVER GUARD
CLIP-ON
STREET RACING
REARSET
FUEL CAPS
STEERING NUT
CRASH PADS
PADDOCK STAND
MIRROR COVERS
REAR-VIEW MIRRORS
FOG LIGHTS KIT
HANDLEBARS
ACCESSORIES
HANDLEBARS

LEVE DI RICAMBIO POMPE FRENO/FRIZIONE OEM

LEVERS: SPARE PARTS FOR BRAKE/CLUTCH MASTER CYLINDERS



LV008



LV009



LV010



LV011



LV015



LV013

Colori / Colours

N  nero - black

O  arancione
orange

Y  oro - gold

B  blu - blue

R  rosso - red

S  argento - silver

G  verde - green

- BRAKE/CLUTCH MASTER CYLINDERS
- ACCESSORIES SPARE PARTS
- CNC-WORKED FLUID RESERVOIR
- FULL CLUTCH
- HYDRAULIC-CLUTCH TRANFORMATION KIT
- LEVER
- THROTTLE CONTROL
- BRAKE CALIPER
- RACING KIT
- BUTTON PANEL
- LEVER GUARD
- CLIP-ON
- STREET RACING REARSET
- FUEL CAPS
- STEERING NUT
- CRASH PADS
- PADOCK STAND
- MIRROR COVERS
- REAR-VIEW MIRRORS
- FOG LIGHTS KIT
- HANDLEBARS ACCESSORIES
- HANDLEBARS

Leve Racing / Racing levers

Marca Brand	Cc	Modello Model	Da From	A To	Freno Brake lever	Frizione Clutch lever	New	Marca Brand	Cc	Modello Model	Da From	A To	Freno Brake lever	Frizione Clutch lever	New
APRILIA	250	RS	1998	2003	LV009			DUCATI	748	SUPERBIKE 748	2001	2001	LV009	LV008	
APRILIA	750	DORSODURO FACTORY	2010	2013		LV008		DUCATI	748	SUPERBIKE 748 E	2001	2002	LV009	LV008	
APRILIA	1000	RSV	1998	1999	LV009	LV008		DUCATI	748	SUPERBIKE 748 R	1999	1999		LV008	
APRILIA	1000	RSV R	2004	2008	LV012	LV014		DUCATI	748	SUPERBIKE 748 R SINGLE-SEAT	2002	2002		LV008	
APRILIA	1000	RSV R DREAM	2004	2008	LV012	LV014		DUCATI	748	SUPERBIKE 748 R SINGLE-SEAT	2000	2001	LV009	LV008	
APRILIA	1000	RSV R FACTORY	2004	2008	LV012	LV014		DUCATI	748	SUPERBIKE 748 RS	2001	2001	LV009	LV008	
APRILIA	1000	RSV R TUONO	2002	2005	LV009	LV008		DUCATI	748	SUPERBIKE 748 RS	2000	2000		LV008	
APRILIA	1000	RSV SP	1999	2000	LV009	LV008		DUCATI	748	SUPERBIKE 748 S	2001	2002	LV009	LV008	
APRILIA	1000	RSV, RSV R	2001	2003	LV009	LV008		DUCATI	748	SUPERBIKE 748 S	2000	2000		LV008	
APRILIA	1000	RSV, RSV R	2000	2000		LV008		DUCATI	748	SUPERBIKE 748 USA	1999	1999		LV008	
APRILIA	1000	RSV4 APRC R	2011	2012	LV012		N	DUCATI	748	SUPERBIKE 749	2003	2003		LV014	
APRILIA	1000	RSV4 APRC R ABS	2013	2014	LV012		N	DUCATI	748	SUPERBIKE 749 DARK	2004	2006		LV014	
APRILIA	1000	RSV4 FACTORY - SBK RACING	2009	2010	LV012		N	DUCATI	748	SUPERBIKE 749 DARK USA	2004	2006		LV014	
APRILIA	1000	RSV4 FACTORY APRC ABS	2013	2014	LV012		N	DUCATI	748	SUPERBIKE 749 R	2004	2006		LV014	
APRILIA	1000	RSV4 FACTORY APRC STD - SE	2011	2012	LV012		N	DUCATI	748	SUPERBIKE 749 R USA	2005	2006		LV014	
APRILIA	1000	RSV4 R	2009	2010	LV012		N	DUCATI	748	SUPERBIKE 749 S	2003	2006		LV014	
APRILIA	1000	RSV4 RACING FACTORY ABS	2018	2018	LV012		N	DUCATI	748	SUPERBIKE 749 S USA	2005	2006		LV014	
APRILIA	1000	RSV4 RACING FACTORY LE	2015	2017	LV012		N	DUCATI	749	749 R	2004	2006	LV012		
APRILIA	1000	RSV4 RR	2015	2018	LV012		N	DUCATI	750	749	2003	2006	LV013	LV015	
APRILIA	1000	RSV4 RR EURO 4 ABS	2019	2019	LV012		N	DUCATI	750	SUPERSPORT 750 SS	1999	2002		LV008	
APRILIA	1000	RSV4 RR RACER PACK	2015	2015	LV012		N	DUCATI	750	SUPERSPORT 750 SS USA	1999	1999		LV008	
APRILIA	1000	SL FALCO	2000	2003	LV009	LV008		DUCATI	795	MONSTER 795 ABS CORSE STRIPE	2014	2015	LV011	LV010	
APRILIA	1000	TUONO R-FACTORY	2006	2009		LV008		DUCATI	795	MONSTER 795 ABS EU THAILAND	2013	2014	LV011	LV010	
APRILIA	1100	RSV4 RACING FACTORY EURO 4 ABS	2019	2019	LV012		N	DUCATI	795	MONSTER 795 ABS RED STRIPE C	2015	2015	LV011	LV010	
APRILIA	1100	TUONO V4 FACTORY	2017	2017	LV012		N	DUCATI	795	MONSTER 795 ABS THAILAND	2014	2014	LV011	LV010	
APRILIA	1100	TUONO V4 FACTORY SUPERPOLE EURO 4	2019	2019	LV012		N	DUCATI	795	MONSTER 795 EU THAILAND	2015	2015	LV011	LV010	
APRILIA	1100	TUONO V4 RF ABS	2018	2018	LV012		N	DUCATI	795	MONSTER 795 THAILAND	2015	2015	LV011	LV010	
APRILIA	1100	TUONO V4 RR	2017	2018	LV012		N	DUCATI	796	MONSTER 796 ABS	2013	2014	LV011	LV010	
APRILIA	1100	TUONO V4 RR EURO 4 ABS	2019	2019	LV012		N	DUCATI	796	MONSTER 796 ABS ANNIVERSARY	2013	2013	LV011	LV010	
APRILIA	1200	CAPONORD	2013	2016		LV008		DUCATI	796	MONSTER 796 ABS S2R THAILAND	2015	2015	LV011	LV010	
APRILIA	1200	CAPONORD CARABINIERI	2015	2015		LV008		DUCATI	796	MONSTER 796 ABS THAILAND	2014	2015	LV011	LV010	
APRILIA	1200	CAPONORD RALLY	2015	2016		LV008		DUCATI	796	MONSTER 796 ABS USA	2013	2014	LV011	LV010	
APRILIA	1200	DORSODURO	2010	2016		LV008		DUCATI	796	MONSTER 796 ABS USA	2012	2012		LV010	
BENELLI	1130	TNT R	2011	2014	LV012		N	DUCATI	796	MONSTER 796 ABS USA ANNIVERS	2013	2013	LV011	LV010	
BENELLI	1130	TNT R160	2010	2012	LV012	LV014		DUCATI	796	MONSTER 796 ANNIVERSARY	2013	2013	LV011	LV010	
BENELLI	1130	TNT R160	2013	2014	LV012		N	DUCATI	796	MONSTER 796 ANNIVERSARY USA	2013	2013	LV011	LV010	
BMW	1000	HP4	2012	2014	LV020			DUCATI	796	MONSTER 796 THAILAND	2014	2014	LV011	LV010	
BMW	1000	S1000 RR	2009	2014	LV020			DUCATI	796	MONSTER 796 USA	2012	2013	LV011	LV010	
DUCATI	660	MONSTER 659 ABS AUSTRALIA	2012	2014	LV011	LV010		DUCATI	800	HYPERMOTARD 796	2010	2012	LV011	LV010	
DUCATI	660	MONSTER 659 AUSTRALIA	2012	2013	LV011	LV010		DUCATI	800	HYPERMOTARD 796 USA	2010	2010		LV010	
DUCATI	696	MONSTER 696	2010	2013	LV011	LV010		DUCATI	800	MONSTER 796	2012	2013	LV011	LV010	
DUCATI	696	MONSTER 696 ABS	2010	2014	LV011	LV010		DUCATI	800	MONSTER 796	2011	2011	LV011	LV010	
DUCATI	696	MONSTER 696 ABS ANNIVERSARY	2013	2013	LV011	LV010		DUCATI	800	MONSTER 796 ABS	2011	2012	LV011	LV010	
DUCATI	696	MONSTER 696 ABS USA	2012	2014	LV011	LV010		DUCATI	800	MONSTER 796 USA	2011	2011	LV011	LV010	
DUCATI	696	MONSTER 696 ABS USA ANNIVERS.	2013	2013	LV011	LV010		DUCATI	850	848	2008	2010	LV012		N
DUCATI	696	MONSTER 696 ANNIVERSARY	2013	2013	LV011	LV010		DUCATI	850	848 EVO	2011	2013	LV012		N
DUCATI	696	MONSTER 696 USA ANNIVERSARY	2013	2013	LV011	LV010		DUCATI	850	848 EVO CORSE SE	2012	2013	LV012		N
DUCATI	700	MONSTER 696 ABS USA	2010	2011	LV011			DUCATI	850	848 EVO CORSE SE USA	2012	2013	LV012		N
DUCATI	700	MONSTER 696 USA	2010	2013	LV011	LV010		DUCATI	850	848 EVO USA	2011	2013	LV012		N
DUCATI	748	749 DARK USA	2004	2006	LV012		N	DUCATI	850	848 HAYDEN	2010	2010	LV012		N
DUCATI	748	749 R USA	2005	2006	LV012		N	DUCATI	850	848 USA	2008	2010	LV012		N
DUCATI	748	749 S	2003	2006	LV012		N	DUCATI	850	SUPERBIKE 848	2010	2010		LV014	
DUCATI	748	749 S USA	2005	2006	LV012		N	DUCATI	850	SUPERBIKE 848	2008	2008		LV014	
DUCATI	748	SUPERBIKE 748	1999	2000		LV008		DUCATI	850	SUPERBIKE 848 EVO	2011	2013		LV014	

BRAKE/CLUTCH MASTER CYLINDERS
 ACCESSORIES SPARE PARTS
 CNC-WORKED FLUID RESERVOIR
 FULL CLUTCH
 HYDRAULIC-CLUTCH TRANFORMATION KIT
 LEVER
 THROTTLE CONTROL
 BRAKE CALIPER
 RACING KIT
 BUTTON PANEL
 LEVER GUARD
 CLIP-ON
 STREET RACING REARSET
 FUEL CAPS
 STEERING NUT
 CRASH PADS
 PADDOCK STAND
 MIRROR COVERS
 REAR-VIEW MIRRORS
 FOG LIGHTS KIT
 HANDLEBARS ACCESSORIES
 HANDLEBARS

Marca Brand	Cc	Modello Model	Da From	A To	Freno Brake lever	Frizione Clutch lever	New	Marca Brand	Cc	Modello Model	Da From	A To	Freno Brake lever	Frizione Clutch lever	New
DUCATI	850	SUPERBIKE 848 EVO CORSE SE	2012	2013		LV014		DUCATI	998	SUPERBIKE 999 S	2003	2006		LV014	
DUCATI	850	SUPERBIKE 848 EVO CORSE SE USA	2012	2013		LV014		DUCATI	998	SUPERBIKE 999 S AMA REPLICIA	2007	2007		LV014	
DUCATI	850	SUPERBIKE 848 EVO USA	2011	2013		LV014		DUCATI	998	SUPERBIKE 999 S USA	2005	2006		LV014	
DUCATI	850	SUPERBIKE 848 HAYDEN	2010	2010		LV014		DUCATI	998	SUPERBIKE 999 USA	2005	2006		LV014	
DUCATI	850	SUPERBIKE 848 USA	2010	2010		LV014		DUCATI	1000	MONSTER S4R	2007	2008	LV012	LV014	
DUCATI	850	SUPERBIKE 848 USA	2008	2008		LV014		DUCATI	1000	MONSTER S4R USA	2007	2008	LV012	LV014	N
DUCATI	900	899 ABS THA	2015	2015	LV013	LV015		DUCATI	1000	MONSTER S4RS	2006	2008	LV012	LV014	
DUCATI	900	899 PANIGALE ABS	2014	2015	LV013	LV015		DUCATI	1000	MONSTER S4RS TRICOLORE	2008	2008	LV012	LV014	N
DUCATI	900	899 PANIGALE ABS USA	2014	2015	LV013	LV015		DUCATI	1000	MONSTER S4RS TRICOLORE USA	2008	2008	LV012	LV014	N
DUCATI	900	MONSTER 900	2000	2001		LV008		DUCATI	1000	MONSTER S4RS USA	2006	2008	LV012	LV014	N
DUCATI	900	SUPERSPORT 900 S	2002	2002		LV008		DUCATI	1000	PANIGALE V4 R	2019	2019	LV013	LV015	N
DUCATI	900	SUPERSPORT 900 SS	1998	2002		LV008		DUCATI	1000	SUPERSPORT 1000 SS	2004	2006	LV009		
DUCATI	900	SUPERSPORT 900 SS USA	1999	1999		LV008		DUCATI	1000	SUPERSPORT 1000 SS USA	2005	2006	LV009		
DUCATI	916	MONSTER S4	2001	2002		LV008		DUCATI	1100	MONSTER 1100	2009	2010	LV012	LV014	N
DUCATI	916	MONSTER S4 FOGARTY	2002	2002		LV008		DUCATI	1100	MONSTER 1100 ABS	2010	2010	LV012	LV014	N
DUCATI	916	SPORT TOURING ST4	2003	2003	LV009			DUCATI	1100	MONSTER 1100 ABS USA	2010	2010	LV012	LV014	N
DUCATI	959	959 PANIGALE ABS	2016	2019	LV013	LV015	N	DUCATI	1100	MONSTER 1100 DIESEL	2013	2013	LV012		N
DUCATI	959	959 PANIGALE ABS BRA	2017	2018	LV013	LV015	N	DUCATI	1100	MONSTER 1100 DIESEL USA	2013	2013	LV012		N
DUCATI	959	959 PANIGALE ABS THA	2016	2019	LV013	LV015	N	DUCATI	1100	MONSTER 1100 EVO ABS	2012	2013	LV012		N
DUCATI	959	959 PANIGALE ABS USA	2018	2019	LV013	LV015	N	DUCATI	1100	MONSTER 1100 EVO ABS USA	2012	2013	LV012		N
DUCATI	959	PANIGALE CORSE	2018	2019	LV013	LV015	N	DUCATI	1100	MONSTER 1100 EVO ANNIVERSARY	2013	2013	LV012		N
DUCATI	959	PANIGALE CORSE U	2018	2019	LV013	LV015	N	DUCATI	1100	MONSTER 1100 S	2009	2010	LV012	LV014	N
DUCATI	996	SPORT TOURING ST4 S	2003	2003	LV009			DUCATI	1100	MONSTER 1100 S ABS	2010	2010	LV012	LV014	N
DUCATI	996	SUPERBIKE 996	2001	2001	LV009	LV008		DUCATI	1100	MONSTER 1100 S ABS USA	2010	2010	LV012	LV014	N
DUCATI	996	SUPERBIKE 996	1999	2000		LV008		DUCATI	1100	MONSTER 1100 S USA	2009	2010	LV012	LV014	N
DUCATI	996	SUPERBIKE 996 R	2001	2001		LV008		DUCATI	1100	MONSTER 1100 USA	2009	2010	LV012	LV014	N
DUCATI	996	SUPERBIKE 996 R II	2001	2001		LV008		DUCATI	1100	MONSTER EVO	2011	2019	LV012		
DUCATI	996	SUPERBIKE 996 S	2001	2001	LV009	LV008		DUCATI	1100	MONSTER S	2009	2013	LV012		
DUCATI	996	SUPERBIKE 996 S USA	1999	1999		LV008		DUCATI	1100	PANIGALE V4	2018	2019	LV013	LV015	N
DUCATI	996	SUPERBIKE 996 SPS	1999	2000		LV008		DUCATI	1100	PANIGALE V4 S	2018	2019	LV013	LV015	N
DUCATI	996	SUPERBIKE 996 SPS II	1999	1999		LV008		DUCATI	1100	PANIGALE V4 S USA	2018	2019	LV013	LV015	N
DUCATI	996	SUPERBIKE 996 SPS III	2000	2000		LV008		DUCATI	1100	PANIGALE V4 SPEICALE	2019	2019	LV013	LV015	N
DUCATI	996	SUPERBIKE 996 USA	1999	1999		LV008		DUCATI	1100	PANIGALE V4 THAILAND	2018	2019	LV013	LV015	N
DUCATI	998	999	2003	2006	LV012		N	DUCATI	1100	PANIGALE V4 USA	2018	2019	LV013	LV015	N
DUCATI	998	999 R	2003	2006	LV012		N	DUCATI	1100	PANIGALE V4S CORSE	2019	2019	LV013	LV015	N
DUCATI	998	999 R USA	2005	2006	LV012		N	DUCATI	1100	PANIGALE V4S THAILAND	2018	2019	LV013	LV015	N
DUCATI	998	999 R XEROX	2006	2006	LV012		N	DUCATI	1200	1199 PANIGALE	2012	2013	LV013	LV015	
DUCATI	998	999 R XEROX USA	2006	2006	LV012		N	DUCATI	1200	1199 PANIGALE ABS	2012	2015	LV013	LV015	
DUCATI	998	999 S	2003	2006	LV012		N	DUCATI	1200	1199 PANIGALE ABS BR	2014	2015	LV013	LV015	
DUCATI	998	999 S AMA REPLICIA	2007	2007	LV012		N	DUCATI	1200	1199 PANIGALE ABS US	2012	2014	LV013	LV015	
DUCATI	998	999 S USA	2005	2006	LV012		N	DUCATI	1200	1199 PANIGALE R	2013	2013	LV013	LV015	
DUCATI	998	999 USA	2005	2006	LV012		N	DUCATI	1200	1199 PANIGALE R USA	2013	2014	LV013	LV015	
DUCATI	998	SUPERBIKE 998	2002	2003	LV009	LV008		DUCATI	1200	1199 PANIGALE S	2012	2013	LV013	LV015	
DUCATI	998	SUPERBIKE 998 FINAL ED.	2004	2004		LV008		DUCATI	1200	1199 PANIGALE S ABS	2012	2014	LV013	LV015	
DUCATI	998	SUPERBIKE 998 FINAL ED. SINGLE	2004	2004		LV008		DUCATI	1200	1199 PANIGALE S TRIC	2012	2013	LV013	LV015	
DUCATI	998	SUPERBIKE 998 MATRIX	2004	2004	LV009	LV008		DUCATI	1200	1199 PANIGALE S USA	2012	2013	LV013	LV015	
DUCATI	998	SUPERBIKE 998 MATRIX SINGLE-SE	2004	2004	LV009	LV008		DUCATI	1200	1199 PANIGALE USA	2012	2013	LV013	LV015	
DUCATI	998	SUPERBIKE 998 R	2002	2002		LV008		DUCATI	1200	MONSTER 1200	2016	2020	LV013	LV015	N
DUCATI	998	SUPERBIKE 998 S BAYLISS	2002	2002		LV008		DUCATI	1200	MONSTER 1200 R	2016	2019	LV013	LV015	N
DUCATI	998	SUPERBIKE 998 S BOSTROM	2002	2002		LV008		DUCATI	1200	MONSTER 1200 R USA	2016	2019	LV013	LV015	N
DUCATI	998	SUPERBIKE 999	2003	2006		LV014		DUCATI	1200	MONSTER 1200 S	2014	2020	LV013	LV015	N
DUCATI	998	SUPERBIKE 999 R	2003	2006		LV014		DUCATI	1200	MONSTER 1200 S STRIPES	2015	2016	LV013	LV015	
DUCATI	998	SUPERBIKE 999 R USA	2005	2006		LV014		DUCATI	1200	MONSTER 1200 S STRIPES USA	2015	2016	LV013	LV015	
DUCATI	998	SUPERBIKE 999 R XEROX	2006	2006		LV014		DUCATI	1200	MONSTER 1200 S USA	2014	2019	LV013	LV015	N
DUCATI	998	SUPERBIKE 999 R XEROX USA	2006	2006		LV014		DUCATI	1200	PANIGALE R	2014	2017	LV013	LV015	

- BRAKE/CLUTCH MASTER CYLINDERS
- ACCESSORIES SPARE PARTS
- CNC-WORKED FLUID RESERVOIR
- FULL CLUTCH
- HYDRAULIC-CLUTCH TRANFORMATION KIT
- LEVER
- THROTTLE CONTROL
- BRAKE CALIPER
- RACING KIT
- BUTTON PANEL
- LEVER GUARD
- CLIP-ON
- STREET RACING REARSET
- FUEL CAPS
- STEERING NUT
- CRASH PADS
- PADDOCK STAND
- MIRROR COVERS
- REAR-VIEW MIRRORS
- FOG LIGHTS KIT
- HANDLEBARS ACCESSORIES
- HANDLEBARS

Marca Brand	Cc	Modello Model	Da From	A To	Freno Brake lever	Frizione Clutch lever	New	Marca Brand	Cc	Modello Model	Da From	A To	Freno Brake lever	Frizione Clutch lever	New	
DUCATI	1200	PANIGALE R USA	2015	2017	LV013	LV015		MOTO MORINI	1200	GRANPASSO	2008	2018	LV012	LV014	N	
DUCATI	1299	1299 S ABS BRASIL	2016	2018	LV013	LV015	N	SUZUKI	600	GSX-R600 K4-K5	2004	2005	LV020			
DUCATI	1299	SUPERBIKE 1299 ABS	2016	2017	LV013	LV015		SUZUKI	600	GSX-R600 K6-K7	2006	2007	LV020			
DUCATI	1299	SUPERBIKE 1299 ABS BRASIL	2016	2016	LV013	LV015		SUZUKI	600	GSX-R600 K8-L0	2008	2010	LV020			
DUCATI	1299	SUPERBIKE 1299 ABS USA	2016	2017	LV013	LV015		SUZUKI	600	GSX-R600 L1	2011	2011	LV020			
DUCATI	1300	1299 ABS	2015	2017	LV013	LV015		SUZUKI	600	GSX-R600 L2	2012	2012	LV020			
DUCATI	1300	1299 ABS BRASIL	2016	2018	LV013	LV015	N	SUZUKI	600	GSX-R600 L3	2013	2013	LV020			
DUCATI	1300	1299 ABS USA	2015	2017	LV013	LV015		SUZUKI	600	GSX-R600 L4	2014	2014	LV020			
DUCATI	1300	1299 R	2017	2018	LV013	LV015	N	SUZUKI	600	GSX-R600 L5	2015	2015	LV020			N
DUCATI	1300	1299 S 90 ANNIVERSARIO	2017	2017	LV013	LV015		SUZUKI	600	GSX-R600 L6	2016	2016	LV020			N
DUCATI	1300	1299 S ABS	2015	2017	LV013	LV015		SUZUKI	600	GSX-R600 L7	2017	2017	LV020			N
DUCATI	1300	SUPERBIKE 1299 S 90 ANNIVERSARIO	2017	2017	LV013	LV015		SUZUKI	750	GSX-R750 K4-K5	2004	2005	LV020			
DUCATI	1300	SUPERBIKE 1299 S ABS	2016	2017	LV013	LV015		SUZUKI	750	GSX-R750 K6-K7	2006	2007	LV020			
DUCATI	1300	SUPERBIKE 1299 S ABS BRASIL	2016	2016	LV013	LV015		SUZUKI	750	GSX-R750 K8-L0	2008	2010	LV020			
DUCATI	1300	SUPERBIKE 1299 S ABS USA	2016	2017	LV013	LV015		SUZUKI	750	GSX-R750 L1	2011	2011	LV020			
HONDA	600	CBR RR	2007	2019	LV019		N	SUZUKI	750	GSX-R750 L2	2012	2012	LV020			
HONDA	1000	CB 1000 R	2008	2013	LV019			SUZUKI	750	GSX-R750 L3	2013	2013	LV020			
HONDA	1000	CBR RR FIREBLADE	2004	2019	LV019		N	SUZUKI	750	GSX-R750 L4	2014	2014	LV020			
HUSQVARNA	250	SMR	2006	2013	LV009			SUZUKI	750	GSX-R750 L5	2015	2015	LV020			N
HUSQVARNA	310	SMR	2009	2013	LV009			SUZUKI	750	GSX-R750 L6	2016	2016	LV020			N
HUSQVARNA	450	SMR	2006	2016	LV009			SUZUKI	750	GSX-R750 L7	2017	2017	LV020			N
HUSQVARNA	510	SMR	2006	2008	LV009			SUZUKI	750	GSX-R750 Z (UF) L4	2014	2014	LV020			
HUSQVARNA	630	SMS	2010	2013	LV009			SUZUKI	1000	GSX-R1000 K5-K6	2005	2006	LV020			
KAWASAKI	750	Z750R ABS PBF-PCF	2011	2012	LV018			SUZUKI	1000	GSX-R1000 K7-K8	2007	2008	LV020			
KAWASAKI	750	Z750R NBF-NCF	2011	2012	LV018			SUZUKI	1000	GSX-R1000 K9-L0	2009	2010	LV020			
KAWASAKI	900	Z900RS CAFE EJF-EKF-ELFA	2018	2020	LV018		N	SUZUKI	1000	GSX-R1000 L1	2011	2011	LV020			
KAWASAKI	900	Z900RS CJF-CJFA-CJFB	2018	2018	LV018		N	SUZUKI	1000	GSX-R1000 L2	2012	2012	LV020			
KAWASAKI	900	Z900RS CKF-CKFA-CKFB	2019	2019	LV018		N	SUZUKI	1000	GSX-R1000 L3	2013	2013	LV020			
KAWASAKI	900	Z900RS CLF-CLFA-CLFB	2020	2020	LV018		N	SUZUKI	1000	GSX-R1000 L4	2014	2014	LV020			
KAWASAKI	1000	Z1000 ABS C7F-C9F	2007	2009	LV018			SUZUKI	1000	GSX-R1000 L5	2015	2015	LV020			N
KAWASAKI	1000	Z1000 ABS EAF-EBF-ECF-ECFA	2010	2012	LV018			SUZUKI	1000	GSX-R1000(A) L6	2016	2016	LV020			N
KAWASAKI	1000	Z1000 ABS EDF-EDFA	2013	2013	LV018			SUZUKI	1000	GSX-R1000A ABS L5	2015	2015	LV020			N
KAWASAKI	1000	Z1000 B7F-B9F	2007	2009	LV018			SUZUKI	1000	GSX-R1000A L7	2017	2017	LV020			N
KAWASAKI	1000	Z1000 DAF-DAS-DBF-DCF-DCFA	2010	2012	LV018			SUZUKI	1000	GSX-R1000A/RA/RZAL L9	2019	2019	LV020			N
KAWASAKI	1000	Z1000 DDF-DDFA	2013	2013	LV018			SUZUKI	1000	GSX-R1000A/RZ L8	2018	2018	LV020			N
KTM	990	SUPER DUKE	2005	2015	LV012			SUZUKI	1000	GSX-R1000R(Z)L7	2017	2017	LV020			N
KTM	990	SUPER DUKE R	2007	2017	LV012			SUZUKI	1000	GSX-R1000Z L4	2014	2014	LV020			
KTM	1190	RC8	2008	2015	LV012			SUZUKI	1000	GSX-S 1000 FA L9	2019	2019	LV020			N
KTM	1190	RC8 R	2009	2014	LV012			SUZUKI	1000	GSX-S1000 A L8	2018	2018	LV020			N
MOTO GUZZI	1200	AQUILA NERA	2007	2017		LV008		SUZUKI	1000	GSX-S1000 A L9	2019	2019	LV020			N
MOTO GUZZI	1200	BELLAGIO	2007	2017		LV008		SUZUKI	1000	GSX-S1000 F L6	2016	2016	LV020			
MOTO GUZZI	1200	BREVA	2005	2018		LV008	N	SUZUKI	1000	GSX-S1000 FA L8	2018	2018	LV020			N
MOTO GUZZI	1200	GRISO	2005	2008		LV008		SUZUKI	1000	GSX-S1000 L6	2016	2016	LV020			
MOTO GUZZI	1200	GRISO 8V	2007	2017		LV008		SUZUKI	1000	GSX-S1000 SRQ/TQMO KATANA	2019	2019	LV020			N
MOTO GUZZI	1200	GRISO 8V SE	2007	2017		LV008		SUZUKI	1300	GSX 1300 BK B-KING K8-L0	2008	2010	LV020			
MOTO GUZZI	1200	GRISO 8V SPECIAL ED.	2007	2017		LV008		TRIUMPH	675	DAYTONA	2006	2013	LV020			
MOTO GUZZI	1200	NORGE	2006	2017		LV008		TRIUMPH	675	DAYTONA R	2011	2013	LV012			
MOTO GUZZI	1225	MGS-01 CORSA	2004	2014	LV012	LV014		TRIUMPH	675	STREET TRIPLE	2012	2015	LV020			
MOTO MORINI	1200	9,5	2007	2017		LV008		TRIUMPH	1050	SPEED TRIPLE	2010	2015	LV012			
MOTO MORINI	1200	CORSARO	2005	2006		LV008		TRIUMPH	1050	SPEED TRIPLE	2008	2009	LV020			
MOTO MORINI	1200	CORSARO	2007	2017	LV012	LV014		YAMAHA	600	YZF-R6	2017	2019	LV020			N
MOTO MORINI	1200	CORSARO CARBON	2007	2017	LV012	LV008		YAMAHA	1000	YZF-R1	2015	2020	LV020			N
MOTO MORINI	1200	CORSARO SCRAMBLER	2009	2019		LV008	N	YAMAHA	1000	YZF-R1 M	2015	2020	LV020			N
MOTO MORINI	1200	CORSARO SPORT	2008	2018		LV008	N									
MOTO MORINI	1200	CORSARO VELOCE	2007	2017	LV012	LV014										

BRAKE/CLUTCH MASTER CYLINDERS
 ACCESSORIES SPARE PARTS
 CNC-WORKED FLUID RESERVOIR
 FULL CLUTCH
 HYDRAULIC-CLUTCH TRANFORMATION KIT
 LEVER
 THROTTLE CONTROL
 BRAKE CALIPER
 RACING KIT
 BUTTON PANEL
 LEVER GUARD
 CLIP-ON
 STREET RACING REARSET
 FUEL CAPS
 STEERING NUT
 CRASH PADS
 PADDOCK STAND
 MIRROR COVERS
 REAR-VIEW MIRRORS
 FOG LIGHTS KIT
 HANDLEBARS ACCESSORIES
 HANDLEBARS

Leve fisse CNC freno - frizione

Brake & clutch CNC-worked levers



Colori leve freno e frizione / Brake & clutch lever colours

N ●
nero - black

O ●
arancione
orange

Y ●
oro - gold

B ●
blu - blue

R ●
rosso - red

S ●
argento - silver

G ●
verde - green

BRAKE/CLUTCH
MASTER CYLINDERS
ACCESSORIES
SPARE PARTS
CNC-WORKED FLUID
RESERVOIR
FULL CLUTCH
HYDRAULIC-CLUTCH
TRANSFORMATION KIT
LEVER
THROTTLE CONTROL
BRAKE CALIPER
RACING KIT
BUTTON PANEL
LEVER GUARD
CLIP-ON
STREET RACING
REARSET
FUEL CAPS
STEERING NUT
CRASH PADS
Paddock STAND
MIRROR COVERS
REAR-VIEW MIRRORS
FOG LIGHTS KIT
HANDLEBARS
ACCESSORIES
HANDLEBARS

Applicazioni / Application list

Marca Brand	CC	Modello Model	Dal From	Al To	Leva freno Brake lever	Leva frizione Clutch lever	Novità New	Marca Brand	CC	Modello Model	Dal From	Al To	Leva freno Brake lever	Leva frizione Clutch lever	Novità New
Aprilia	660	Pegaso Strada - Factory - Trail	2005	2009	EDF016			Bmw	1157	R1200 GS	2004	2012	EDB001	ESB002	
Aprilia	660	Rs 660	2021	2022	EDF011	ESV004	N	Bmw	1157	R1200 GS Adventure	2006	2013	EDB001	ESB002	
Aprilia	660	Tuono 660	2021	2022	EDF011	ESV004	N	Bmw	1157	R1200 R	2006	2014	EDB001	ESB002	
Aprilia	750	Dorsoduro 750	2008	2016	EDF023	ESC023		Bmw	1157	R1200 RT / SE	2010	2013	EDB001	ESB002	
Aprilia	750	Dorsoduro Factory	2010	2013	EDF023	ESC080		Bmw	1157	R1200 S	2006	2008	EDB001	ESB002	
Aprilia	750	Shiver 750	2007	2016	EDF023	ESC023		Bmw	1157	R1200 ST	2005	2008	EDB001	ESB002	
Aprilia	750	Shiver GT	2009	2016	EDF023	ESC023	N	Bmw	1170	Hp2 Enduro	2005	2008	EDB001	ESB002	
Aprilia	850	Mana	2007	2012	EDF023			Bmw	1170	Hp2 Megamoto	2006	2009	EDB001	ESB002	
Aprilia	850	Mana GT	2009	2016	EDF023			Bmw	1170	Hp2 Sport	2008	2011	EDM001	ESM011	
Aprilia	900	Dorsoduro 900	2017	2020	EDF023	ESC023	N	Bmw	1170	R Nine T	2014	2016	EDB077	ESC075	N
Aprilia	900	Shiver 900	2017	2020	EDF023	ESC023	N	Bmw	1200	R1200 GS (Lc)	2013	2019	EDB077	ESC075	N
Aprilia	1000	Etv Caponord Abs	2004	2007	EDF016	ESC080		Bmw	1200	R1200 GS Adventure (Lc)	2014	2019	EDB077	ESC075	N
Aprilia	1000	Etv Caponord Rally	2002	2007	EDF016	ESC080		Bmw	1200	R1200 R	2015	2019	EDB077	ESC075	N
Aprilia	1000	Falco / SL 1000	2000	2004	EDB080	ESC080		Bmw	1200	R1200 RS	2015	2019	EDB077	ESC075	N
Aprilia	1000	Rst Futura	2001	2004	EDF016	ESC080		Bmw	1200	R1200 RT	2014	2019	EDB077	ESC075	N
Aprilia	1000	Rsv Mille / R	1999	2003	EDB080	ESC080		Bmw	1250	R 1250 GS	2018	2019	EDB077	ESC075	N
Aprilia	1000	Rsv Mille / R	2004	2008	EDF099	ESH011		Bmw	1250	R 1250 GS Adventure	2018	2019	EDB077	ESC075	N
Aprilia	1000	Rsv R - Factory - Dream	2004	2019	EDF011	ESV004	N	Bmw	1293	K1300 S / R / GT	2009	2016	EDB001	ESB002	
Aprilia	1000	Rsv Rr Racer Pack	2015	2015	EDF011	ESV004		Bmw	1649	K1600 GT / GTI	2011	2016	EDB001	ESB002	
Aprilia	1000	Rsv4 Aprc R	2011	2012	EDF011	ESV004		Bmw	1649	K1600 GT / GTI	2017	2019	EDB077	ESC075	
Aprilia	1000	Rsv4 Aprc R Abs	2013	2014	EDF011	ESV004		Buell	985	Xb9	2003	2009	EDF021	ESB055	
Aprilia	1000	Rsv4 Factory - Sbk Racing	2009	2010	EDF011	ESV004		Buell	1125	1125 CR	2009	2009	EDF014	ESC777	
Aprilia	1000	Rsv4 Factory Aprc	2011	2012	EDF011	ESV004		Buell	1125	1125 R	2008	2009	EDF014	ESC777	
Aprilia	1000	Rsv4 R	2009	2019	EDF011	ESV004	N	Buell	1200	S1 Lightning	1997	1998	EDF014	ESB055	
Aprilia	1000	Rsv4 Racing Factory Aprc Abs	2013	2014	EDF011	ESV004		Buell	1200	X1 Lightning	1998	2002	EDF014	ESB055	
Aprilia	1000	Rsv4 Racing Factory LE	2015	2017	EDF011	ESV004		Buell	1203	M2 Cyclone	1997	2002	EDF014	ESB055	
Aprilia	1000	Rsv4 RF	2009	2019	EDF011	ESV004	N	Buell	1203	Ulysses Xb12 X	2009	2009	EDF021	ESB055	
Aprilia	1000	Rsv4 RR	2015	2019	EDF011	ESV004	N	Buell	1203	Ulysses Xb12 XT	2009	2009	EDF021	ESB055	
Aprilia	1000	Tuono / R	2003	2010	EDB080	ESC080		Buell	1203	Xb12	2004	2008	EDF021	ESB055	
Aprilia	1000	Tuono V4R / Factory	2011	2016	EDB080	ESV004		Buell	1203	Xb12 R	2009	2009	EDF014	ESB055	
Aprilia	1100	RSV4 Factory	2021	2022	EDF011	ESV004	N	Buell	1203	Xb12 SCG	2009	2009	EDF014	ESB055	
Aprilia	1100	Tuono V4 1100 RR / Factory	2017	2021	EDF099	ESV04A	N	Buell	1203	Xb12 SS	2009	2009	EDF014	ESB055	
Aprilia	1200	Caponord 1200 / Rally	2014	2017	EDB080	ESC080		Ducati	400	Monster 400	2004	2007	EDB012	ESD022	
Aprilia	1200	Dorsoduro	2010	2016	EDB080	ESC080		Ducati	400	Monster M 400	1999	2003	EDB012	ESC012	
Benelli	250	Bn251	2016	2017	EDF016	ESD037	N	Ducati	600	Monster M 600	1994	2001	EDB012	ESC012	
Benelli	250	Trk251	2019	2019	EDF016		N	Ducati	620	620 Monster / 620 MTS	2003	2006	EDB012	ESD022	
Benelli	300	Bn302	2015	2017	EDF016	ESD037	N	Ducati	620	Monster M 620	2002	2003	EDB012	ESC012	
Benelli	400	Imperiale	2019	2021	EDF016		N	Ducati	695	695 Monster	2007	2008	EDB012	ESD022	
Benelli	500	Leocino	2017	2020	EDF016	ESD037	N	Ducati	700	696 Monster	2009	2014	EDB012	ESD022	
Benelli	500	Leocino Trail	2018	2020	EDF016	ESD037	N	Ducati	748	748	1995	1998	EDB012	ESC012	
Benelli	500	Trk502	2017	2018	EDF016	ESD037	N	Ducati	748	748 SS	1999	2002	EDB080	ESC080	
Benelli	600	Bn600	2014	2016	EDF016	ESD037	N	Ducati	748	749 / S / R	2003	2006	EDF011	ESH011	
Benelli	600	Bn600 GT	2015	2016	EDF016	ESD037	N	Ducati	750	750 SS	1999	2002	EDB080	ESC080	
Benelli	600	Bn600 R	2014	2014		ESD037	N	Ducati	750	Monster M 750 / M750 IE	1994	2002	EDB012	ESC012	
Bmw	650	F650 GS	2008	2012	EDB001	ESB008		Ducati	800	796 Monster	2011	2014	EDB012	ESD022	
Bmw	700	F700 GS	2013	2017	EDB001	ESB008		Ducati	800	797 Monster	2017	2018	EDB012	ESD082	N
Bmw	798	F800 GS/Adventure	2008	2018	EDB001	ESB008	N	Ducati	800	Hypermotard 796	2010	2014	EDB012	ESD022	
Bmw	798	F800 GT	2013	2018	EDB001	ESB008	N	Ducati	800	Monster S2R 800	2005	2007	EDB012	ESC022	
Bmw	798	F800 R	2009	2018	EDB001	ESB008	N	Ducati	800	Scrambler (Not Cafe Racer)	2019	2019	EDB012	ESD022	N
Bmw	798	F800 S	2006	2014	EDB001	ESB008		Ducati	800	Scrambler 800	2015	2017	EDB012	ESD082	
Bmw	798	F800 ST	2006	2015	EDB001	ESB008		Ducati	800	Scrambler Cafe Racer	2019	2019	EDD001	ESH011	N
Bmw	999	S1000r (W And W/O Cc)	2014	2014	EDF022	ESB022		Ducati	800	Scrambler Cafè Racer	2017	2017	EDD001	ESD082	
Bmw	999	S1000r (W And W/O Cc)	2015	2019	EDF022	ESB22H	N	Ducati	800	Scrambler Desert Sled	2017	2017	EDD001	ESD082	N
Bmw	999	S1000rr (Not Comp Ver.)	2010	2014	EDF022	ESB022		Ducati	821	821 Monster / Dark / Stripe	2014	2017	EDB012	ESD082	
Bmw	999	S1000rr (Not Comp Ver.)	2015	2019	EDF022	ESB22H	N	Ducati	821	821 Monster / Dark / Stripe	2018	2019	EDB012	ESD082	N
Bmw	1157	K1200 R	2005	2008	EDB001	ESB002		Ducati	821	Hypermotard 821 / Hyperstrada	2013	2015	EDB012	ESD082	
Bmw	1157	K1200 R Sport	2006	2008	EDB001	ESB002		Ducati	821	Hypermotard 821 SP	2013	2015	EDD001	ESD082	
Bmw	1157	K1200 S	2004	2008	EDB001	ESB002		Ducati	848	848 / Evo	2007	2013	EDF011	ESH011	

BRAKE/CLUTCH
 MASTER CYLINDERS
 ACCESSORIES
 SPARE PARTS
 CNC-WORKED FLUID
 RESERVOIR
 FULL CLUTCH
 HYDRAULIC-CLUTCH
 TRANFORMATION KIT
 LEVER
 THROTTLE CONTROL
 BRAKE CALIPER
 RACING KIT
 BUTTON PANEL
 LEVER GUARD
 CLIP-ON
 STREET RACING
 REARSET
 FUEL CAPS
 STEERING NUT
 CRASH PADS
 PADDOCK STAND
 MIRROR COVERS
 REAR-VIEW MIRRORS
 FOG LIGHTS KIT
 HANDLEBARS
 ACCESSORIES
 HANDLEBARS

Marca Brand	CC	Modello Model	Dal From	Al To	Leva freno Brake lever	Leva frizione Clutch lever	Novità New	Marca Brand	CC	Modello Model	Dal From	Al To	Leva freno Brake lever	Leva frizione Clutch lever	Novità New
Ducati	848	Streetfighter 848	2012	2015	EDF011	ESH011		Honda	599	Cbr600 RR	2007	2021	EDF033	ESY688H	N
Ducati	899	899 Panigale	2014	2015	EDF099	ESH011		Honda	599	Cbr600 RR	2007	2019	EDF033	ESY688H	N
Ducati	900	900 SS	1991	1997	EDB012	ESC012		Honda	600	Cb599 / Cb600 Hornet	1998	2006	EDF018	ESH626	
Ducati	900	900 SS	1998	2006	EDB080	ESC080		Honda	600	Cb600 F	2007	2013	EDF018	ESH607	
Ducati	900	M900 / M1000	2000	2005	EDB080	ESC080		Honda	600	Cbf600 / SA	2010	2013	EDF018	ESH607	
Ducati	900	Monster M 900	1993	1999	EDB012	ESC012		Honda	600	Cbr 600 F2,F3,F4,F4i	1991	2007	EDF018	ESH626	
Ducati	936	Hypermotard 939 / Strada	2016	2017	EDB012	ESD082		Honda	600	Cbr600 F	2011	2013	EDF018	ESH607	
Ducati	936	Hypermotard 939 / Strada	2018	2018	EDB012	ESD082	N	Honda	650	Cbr650 F / Cb650 F	2014	2021	EDF018	ESH065	N
Ducati	936	Hypermotard 939 SP	2016	2017	EDD001	ESD082		Honda	700	Nc700 S / X	2016	2020	EDF018	ESH065	N
Ducati	936	Hypermotard 939 SP	2018	2018	EDD001	ESD082	N	Honda	700	Nc700 S / X	2012	2015	EDF018	ESH626	
Ducati	936	Supersport / S	2017	2020	EDF099		N	Honda	748	Vf750 S Sabre	1982	1986	EDF018	ESV000	
Ducati	936	Supersport / S	2017	2019		ESD082	N	Honda	748	Vfr750	1991	1997	EDF018	ESV000	
Ducati	944	St2	1997	2003	EDB012	ESC012		Honda	748	Vfr800	1998	2001		ESV000	
Ducati	950	Hypermotard 950	2019	2022	EDF099	ESH011	N	Honda	748	Vfr800 / F	2002	2019	EDF018	ESV000	N
Ducati	950	Multistrada 950	2017	2021	EDB012	ESD082	N	Honda	748	Vft750 Phantom / Shadow	2010	2019	EDF018	ESH626	N
Ducati	950	Multistrada/S 950	2019	2021	EDF011	ESH011	N	Honda	750	Black Spirit	2014	2016	EDF018	ESH250	
Ducati	950	Panigale V2	2020	2020	EDF011	ESH011	N	Honda	750	Nc 750 S / X	2014	2015	EDF018	ESH250	
Ducati	959	959 Panigale	2016	2018	EDF099	ESH011	N	Honda	900	Cbr 900 RR	1993	1999	EDF018	ESH626	
Ducati	996	996 / 998 / B / S / R	1999	2003	EDB080	ESC080		Honda	919	Cb 919	2002	2007	EDF018	ESH626	
Ducati	996	Monster Ms4 / Ms4 R	2001	2006	EDB080	ESC080		Honda	929	Cbr 929 RR	2000	2001	EDF029	ESH626	
Ducati	996	St4	1999	2003	EDB012	ESC012		Honda	954	Cbr 954 RR	2002	2003	EDF029	ESY688H	
Ducati	996	St4 S	2003	2003	EDB012	ESD022	N	Honda	998	Cb 1000 R	2008	2016	EDF033	ESH033	
Ducati	996	St4 S / Abs	2001	2003	EDB012	ESD022		Honda	998	Cb 1000 R Neosportcafe	2018	2019	EDF033	ESY688H	N
Ducati	996	St4 S / Abs	2004	2006	EDB080	ESC080		Honda	998	Cbr 1000 RR / Fireblade	2004	2007	EDF033	ESH033	
Ducati	998	999 / S / R	2003	2006	EDF011	ESH011		Honda	998	Cbr 1000 RR / Fireblade / SP	2017	2021	EDF033	ESY688H	N
Ducati	1000	1000 SS	1998	2006	EDB080	ESC080		Honda	998	Cbr 1000 RR / Fireblade / SP	2008	2016	EDF033	ESY688H	
Ducati	1000	916 / 996 SPS	1994	1998	EDB012	ESC012		Honda	998	Cbr 1000RR-R/ SP	2020	2021	EDF011	ESY688H	N
Ducati	1000	Gt 1000	2006	2010	EDB080	ESC080		Honda	1000	Cbf 1000	2006	2009	EDF018	ESV000	
Ducati	1000	Monster S2R 1000	2006	2008	EDB080	ESC080		Honda	1000	Cbf 1000 / A	2010	2013	EDF018	ESH033	
Ducati	1000	Monster S4RS	2006	2008	EDF011	ESH011		Honda	1000	Crf 1000 L African Twin	2016	2019	EDF018		N
Ducati	1000	Mts1000 SDS / DS	2004	2006	EDB080	ESC080		Honda	1000	Rc51 / Rvt1000 Sp-1 / Sp-2	2000	2006	EDF029	ESH033	
Ducati	1000	Paul Smart LE	2006	2006	EDB080	ESC080		Honda	1000	Vtr 1000 F / Firestorm	1998	2005	EDF018	ESV000	
Ducati	1000	Sport 1000	2006	2009	EDB080	ESC080		Honda	1100	Cb 1100 / Gio Special / Ex / Rs	2013	2019	EDF018	ESH033	N
Ducati	1000	St3 / S / Abs	2003	2007	EDB080	ESC080		Honda	1100	Cbr 1100 XX / Blackbird	1997	2007		ESV000	
Ducati	1078	M1100 / S / Evo Monster	2009	2013	EDF011	ESH011		Honda	1100	X-11	1999	2002		ESH626	
Ducati	1078	Mts1100 / S	2007	2009	EDB080	ESC080		Honda	1200	Crosstourer	2013	2018	EDF018	ESH033	N
Ducati	1098	Streetfighter 1098/S	2009	2013	EDF011	ESH011	N	Honda	1200	Crosstourer DCT	2014	2018	EDF018		N
Ducati	1100	1098 / S / Tricolor	2007	2008	EDF011	ESH011		Honda	1200	Vfr 1200 / F	2010	2016	EDF012	ESH033	
Ducati	1100	Hypermotard 1100 / S / Evo Sp	2007	2012	EDD001	ESH011		Honda	1200	Vfr 1200 / F	2016	2017	EDF018	ESH033	N
Ducati	1100	Panigale V4 / S / R	2018	2020	EDF011	ESH011	N	Honda	1300	Fury / Vtx 1300 CX	2009	2018	EDF018	ESH626	N
Ducati	1100	Scrambler 1100 / Sport / Special	2018	2019	EDB012	ESD022	N	Honda	1300	St 1300	2008	2012	EDF012	ESV000	
Ducati	1110	Streetfighter / S	2009	2013	EDF011	ESH011		Honda	1300	St1300 / St1300 A	2003	2007		ESV000	
Ducati	1199	1199 Panigale / S / Tricolor	2012	2016	EDF099	ESH011		Honda	1300	Vtx 1300	2003	2008	EDF018	ESH626	
Ducati	1200	1198 / S / R	2009	2011	EDF011	ESH011		Husqvarna	400	Vitpilen 401	2018	2020	EDF039	ESK390	N
Ducati	1200	Diavel / Carbon	2011	2018	EDF011	ESH011	N	Husqvarna	400	Svartpilen 401	2018	2020	EDF039	ESK390	N
Ducati	1200	Diavel / Carbon / Xdiavel / S	2011	2020	EDF099	ESH011	N	Husqvarna	450	Fs 450	2017	2020	EDD001	ESA090	N
Ducati	1200	Monster 1200 / S / R	2014	2019	EDF099	ESH011	N	Husqvarna	700	701 Supermoto / Enduro	2017	2020	EDB012	ESA090	N
Ducati	1200	Multistrada 1200 / S / GT	2010	2020	EDF011	ESH011	N	Husqvarna	900	Nuda 900 / R	2011	2013	EDD001	ESB008	N
Ducati	1299	1299 Panigale / S / R	2015	2020	EDF099	ESH011	N	Hyosung	250	Comet Gt 250 R Fi Euro3	2007	2008	EDF008	ESH008	
Honda	125	C125 Super Cub	2019	2019	EDF025		N	Hyosung	250	Gt250 R Carburetion	2006	2010	EDF008	ESH008	
Honda	125	Cb125 F / R	2019	2020	EDF025	ESH626	N	Hyosung	450	Te Rapier	2007	2008	EDF008	ESH008	
Honda	125	Grom / Msx125	2014	2022	EDF025	ESH250	N	Hyosung	650	Gt 650 FI Mikuni	2007	2008	EDF008	ESH008	
Honda	125	Monkey (Z125)	2019	2021	EDF025	ESH626	N	Hyosung	650	Gt 650 R	2006	2009	EDF008	ESH008	
Honda	250	Cbr250r	2011	2013	EDF025	ESH250		Hyosung	650	Gt 650 R FI Mikuni	2007	2007	EDF008	ESH008	
Honda	300	Cbr300 R / Cb300 F / FA	2014	2021	EDF025	ESH250	N	Hyosung	650	Gt 650 R TTC Carburetion	2006	2006	EDF008	ESH008	
Honda	300	Cmx 300 / Rebel	2017	2021	EDF025	ESH250	N	Hyosung	700	St7	2010	2010	EDF008	ESH008	
Honda	500	Cbr500 R / Cb500 F / X	2013	2021	EDF025	ESH250	N	Kawasaki	125	Ninja 125	2019	2019	EDF025	ESK025	N
Honda	500	Cmx 500 / Rebel	2017	2021	EDF025	ESH250	N	Kawasaki	125	Z 125	2017	2020	EDF025	ESK025	N
Honda	599	Cbr600 RR	2003	2006	EDF029	ESY688H		Kawasaki	250	Ninja 250 R	2008	2012	EDF025	ESK025	

- BRAKE/CLUTCH MASTER CYLINDERS
- ACCESSORIES SPARE PARTS
- CNC-WORKED FLUID RESERVOIR
- FULL CLUTCH
- HYDRAULIC-CLUTCH TRANFORMATION KIT
- LEVER
- THROTTLE CONTROL
- BRAKE CALIPER
- RACING KIT
- BUTTON PANEL
- LEVER GUARD
- CLIP-ON
- STREET RACING REARSET
- FUEL CAPS
- STEERING NUT
- CRASH PADS
- PADDOCK STAND
- MIRROR COVERS
- REAR-VIEW MIRRORS
- FOG LIGHTS KIT
- HANDLEBARS ACCESSORIES
- HANDLEBARS

Marca Brand	CC	Modello Model	Dal From	Al To	Leva freno Brake lever	Leva frizione Clutch lever	Novità New	Marca Brand	CC	Modello Model	Dal From	Al To	Leva freno Brake lever	Leva frizione Clutch lever	Novità New
Kawasaki	250	Z 250 SL	2015	2017	EDF025	ESK025		Ktm	200	200 Duke / Rc200	2014	2016	EDF039	ESK390	
Kawasaki	300	Ninja 300 R / Z300 Con E Senza Abs	2013	2018	EDF025	ESK025	N	Ktm	390	390 Duke / Rc390	2013	2019	EDF039	ESK390	N
Kawasaki	300	Versys-X Abs	2017	2020	EDF025	ESK025	N	Ktm	690	690 Duke	2008	2011	EDF011	ESM011	
Kawasaki	400	Ninja 400 R	2018	2019	EDF025	ESK025	N	Ktm	690	690 Duke R	2014	2019	EDF011	ESA090	N
Kawasaki	400	Ninja 400 R	2011	2011	EDF044	ESK750		Ktm	690	690 Enduro R	2014	2020	EDB012	ESA090	N
Kawasaki	400	Zxr 400	1990	1999	EDF014	ESK750		Ktm	690	690 Smc / Smc-R / Duke / Duke R	2012	2013	EDB012	ESM069	
Kawasaki	500	Er5	2004	2005	EDF014	ESK750		Ktm	690	Smc / Smc-R	2014	2021	EDB012	ESA090	
Kawasaki	500	Gpz 500 / Ex500 R Ninja	1990	2009	EDF014	ESK750		Ktm	999	990 Smr / Smt	2009	2013	EDD001	ESM069	
Kawasaki	600	Zx-6	1990	1999	EDF014	ESK750		Ktm	999	990 Superduke	2005	2012	EDF011	ESM011	
Kawasaki	600	Zx6r / Zx636 R / Zx6 RR	2000	2004	EDF014	ESK828		Ktm	1050	Adventure 1050	2016	2016	EDB012	ESA090	
Kawasaki	600	Zzr 600	1990	2004	EDF014	ESK750		Ktm	1090	1090 Adventure R	2017	2019	EDB012	ESA090	N
Kawasaki	600	Zzr 600	2005	2009	EDF014	ESK828		Ktm	1195	1190 Adventure / R	2013	2016	EDD001	ESA090	
Kawasaki	626	Zx636 R / Zx6 RR	2005	2006	EDF035	ESK828		Ktm	1195	Rc8 / R	2009	2016	EDF011	ESM011	
Kawasaki	636	Zx6 R / 636	2007	2018	EDF088	ESK828	N	Ktm	1301	1290 Super Duke R / GT	2014	2021	EDF011	ESM011	N
Kawasaki	636	Zx6 R / 636	2019	2020	EDF088	ESK828	N	Ktm	1301	Super Adventure 1290 S / T / R	2015	2020	EDD001	ESA090	N
Kawasaki	650	Ninja650 R / Er-6 F	2017	2020	EDF021	ESK750	N	Moto Guzzi	744	V7 Classic / Stornello	2008	2020	EDF016	ESD037	N
Kawasaki	650	Ninja650 R / Er-6 F / Er-6 N	2006	2008	EDF014	ESK750		Moto Guzzi	744	V7 Milano / Carbon / Rough	2018	2020	EDF016	ESD037	N
Kawasaki	650	Ninja650 R / Er-6 F / Er-6 N	2009	2016	EDF044	ESK750		Moto Guzzi	744	V7 Racer	2011	2020	EDF016	ESD037	N
Kawasaki	650	Versys (650cc)	2006	2008	EDF014	ESK750		Moto Guzzi	744	V7 Stone / Special	2012	2020	EDF016	ESD037	N
Kawasaki	650	Versys (650cc)	2009	2014	EDF044	ESK750		Moto Guzzi	750	Breva 750	2004	2009	EDF016	ESD037	
Kawasaki	650	Versys 650 CC	2015	2020	EDF021	ESK750	N	Moto Guzzi	850	Breva 850	2006	2007	EDF016	ESC080	
Kawasaki	650	Vulcan/S 650 CC	2015	2020	EDF021	ESK750	N	Moto Guzzi	850	Norge 850	2007	2007	EDF016	ESC080	
Kawasaki	650	Z650	2017	2020	EDF021	ESK750	N	Moto Guzzi	850	V85	2018	2019	EDB080	ESC037	N
Kawasaki	750	Z750 (Not Z750 S Model)	2007	2012	EDF021	ESK828		Moto Guzzi	850	V9 Bobber / Roamer	2016	2020	EDF016	ESC037	
Kawasaki	750	Z750 R	2011	2012	EDF088	ESK828		Moto Guzzi	936	Bellagio - Aquila Nera	2007	2013	EDF016	ESC080	
Kawasaki	750	Z750 S (Not Z750 Model)	2006	2008	EDF014	ESK750		Moto Guzzi	1100	Breva 1100	2006	2012	EDF016	ESC080	
Kawasaki	750	Zr750 Zephir	1991	1993	EDF014	ESK750		Moto Guzzi	1151	Stelvio	2008	2016	EDF016	ESC080	
Kawasaki	750	Zx7 R / Zx7 RR	1989	2003	EDF014	ESC777		Moto Guzzi	1200	1200 Sport	2007	2013	EDF016	ESC080	
Kawasaki	800	W800 / Se	2012	2016	EDF014	ESK750		Moto Guzzi	1200	Breva 1200	2007	2007	EDF016	ESC080	
Kawasaki	800	Z800 / E Version	2013	2016	EDF021	ESK828		Moto Guzzi	1200	Griso	2006	2016	EDF016	ESC080	
Kawasaki	900	Z900	2017	2020	EDF021	ESK750	N	Moto Guzzi	1200	Norge 1200 / GT8v	2006	2015	EDF016	ESC080	
Kawasaki	900	Z900 RS	2018	2020	EDF088	ESK750	N	Moto Guzzi	1380	Mgx 21	2016	2020	EDF023	ESC023	N
Kawasaki	900	Zx9	1994	1997	EDF014	ESC777		Moto Guzzi	1400	Audace	2015	2020	EDF023	ESC023	N
Kawasaki	900	Zx9 R	1998	1999	EDF014	ESK750		Moto Guzzi	1400	California Custom / Touring / Classic	2014	2020	EDF023	ESC023	N
Kawasaki	900	Zx9 R	2000	2003	EDF014	ESK828		Moto Guzzi	1400	Eldorado	2015	2020	EDF023	ESC023	N
Kawasaki	1000	H2 / H2 R	2015	2020	EDF099	ESH011	N	Mv Agusta	675	Brutale 675	2012	2017	EDF015	ESM048	
Kawasaki	1000	Versys 1000	2012	2014	EDF014	ESK828		Mv Agusta	675	F3 675	2013	2020	EDF035	ESM048	
Kawasaki	1000	Versys 1000	2015	2019	EDF021	ESK750	N	Mv Agusta	800	Brutale 800 / RR	2012	2015	EDF015	ESM048	
Kawasaki	1000	Z1000	2003	2006	EDF014	ESK828		Mv Agusta	800	Dragster 800 / RR	2014	2016	EDF015	ESM048	
Kawasaki	1000	Z1000	2007	2016	EDF088	ESK828		Mv Agusta	800	F3 800 / AGO / RC	2014	2018	EDF035	ESM048	N
Kawasaki	1000	Z1000 R	2017	2019	EDF088	ESK750	N	Mv Agusta	800	F3 800 / AGO / RC / AMG	2014	2020	EDF035	ESM048	
Kawasaki	1000	Z1000 SX / Ninja 1000 / Tourer	2011	2016	EDF088	ESK828		Mv Agusta	800	Rivale 800	2014	2017	EDF015	ESM048	
Kawasaki	1000	Z1000 SX / Ninja 1000 / Tourer	2017	2019	EDF088	ESK750	N	Mv Agusta	800	Stradale	2015	2015	EDF015		
Kawasaki	1000	Zg1000 Concours	1992	2006	EDF014	ESC777		Mv Agusta	800	Turismo Veloce 800	2014	2017	EDF015	ESM048	
Kawasaki	1000	Zx10 R	2004	2005	EDF014	ESK828		Mv Agusta	920	Brutale 920 / 990 R / 1090 RR	2010	2011	EDF015		
Kawasaki	1000	Zx10 R	2006	2015	EDF088	ESK828		Mv Agusta	1000	Brutale 1000RR	2020	2020	EDF011	ESH011	N
Kawasaki	1000	Zx10R / RR / KRT / SE	2016	2020	EDF099	ESK828	N	Mv Agusta	1000	F4 / F4 R / F4 RR	2013	2015	EDF011	ESH011	
Kawasaki	1100	Zrx 1100	1999	2007	EDF014	ESC777		Mv Agusta	1000	F4 RC	2011	2018	EDF011	ESH011	N
Kawasaki	1100	Zx1100 / Zx11	1990	2001	EDF014	ESC777		Mv Agusta	1000	F4 RR	2011	2018	EDF011	ESH011	N
Kawasaki	1200	Zrx 1200	1999	2007	EDF014	ESC777		Mv Agusta	1000	F4 S / R / RR / Freccia Tricolore	2010	2012	EDF011	ESH011	
Kawasaki	1200	Zx12 R	2000	2006	EDF014	ESK828		Mv Agusta	1000	RUSH	2020	2020	EDF011	ESH011	N
Kawasaki	1200	Zzr 1200	2002	2005	EDF014	ESC777		Mv Agusta	1000	Super Veloce Serie Oro	2020	2020	EDF035	ESM048	N
Kawasaki	1400	Gtr 1400 / Concours	2007	2019	EDF088	ESH088	N	Mv Agusta	1090	Brutale 1090 / 1090 R / Corsa	2013	2015	EDF015		
Kawasaki	1400	Zx1400 / Zx14 R / Zzr 1400	2006	2017	EDF088	ESH088		Mv Agusta	1090	Brutale R / RR	2012	2012	EDF015		
Kawasaki	1400	Zzr / Zx1400 Se Version	2016	2020	EDF099	ESH088	N	Suzuki	250	Gsx250 R	2017	2020	EDF014	ESS248	N
Ktm	125	Rc 125	2014	2018	EDF039	ESK390	N	Suzuki	250	V-Strom	2018	2020	EDF014	ESS248	N
Ktm	125	Rc 125 / 125 Duke	2014	2021	EDF039	ESK390	N	Suzuki	600	600 Katana	1998	2006	EDF014	ESS650	
Ktm	200	200 Duke	2021	2021	EDF039	ESK390	N	Suzuki	600	Gsr 600	2006	2011	EDF014	ESS248	

BRAKE/CLUTCH
 MASTER CYLINDERS
 ACCESSORIES
 SPARE PARTS
 CNC-WORKED FLUID
 RESERVOIR
 FULL CLUTCH
 HYDRAULIC-CLUTCH
 TRANFORMATION KIT
 LEVER
 THROTTLE CONTROL
 BRAKE CALIPER
 RACING KIT
 BUTTON PANEL
 LEVER GUARD
 CLIP-ON
 STREET RACING
 REARSET
 FUEL CAPS
 STEERING NUT
 CRASH PADS
 PADDOCK STAND
 MIRROR COVERS
 REAR-VIEW MIRRORS
 FOG LIGHTS KIT
 HANDLEBARS
 ACCESSORIES
 HANDLEBARS

Marca Brand	CC	Modello Model	Dal From	Al To	Leva freno Brake lever	Leva frizione Clutch lever	Novità New	Marca Brand	CC	Modello Model	Dal From	Al To	Leva freno Brake lever	Leva frizione Clutch lever	Novità New
Suzuki	600	Gsxr 600	1997	2003	EDF014	ESS248		Triumph	955	Daytona 955 I	1997	2003	EDF014	EST955	
Suzuki	600	Gsxr 600	2004	2005	EDF035	ESS248		Triumph	955	Daytona 955 I	2004	2006	EDF014	EST333	
Suzuki	600	Gsxr 600	2006	2014	EDF035	ESS035	N	Triumph	1050	Speed Triple	1997	2003	EDF014	EST955	
Suzuki	600	Gsxr 600	2015	2019	EDF035	ESV004	N	Triumph	1050	Speed Triple	2004	2007	EDF014	EST333	
Suzuki	650	Bandit S	2015	2015	EDF014	ESS014	N	Triumph	1050	Speed Triple	2008	2010	EDF035	EST333	
Suzuki	650	DL 650 / V-Strom / Mx	2011	2020	EDF014	ESS248	N	Triumph	1050	Speed Triple 1050	2011	2015	EDF011	EST333	
Suzuki	650	Gsf 650 Bandit	2005	2007	EDF014	ESS014		Triumph	1050	Speed Triple 1050 / S	2016	2020	EDF099	EST333P	N
Suzuki	650	Gsx650 F	2008	2015	EDF014	ESS014		Triumph	1050	Speed Triple R	2012	2015	EDF011	EST333	
Suzuki	650	Sfv 650 Gladius	2009	2015	EDF014			Triumph	1050	Speed Triple R	2016	2018	EDF099	EST333P	N
Suzuki	650	Sv 650 / S	1999	2009	EDF014	ESS650		Triumph	1050	Sprint GT	2011	2015	EDF014	EST333	
Suzuki	650	Sv 650 / X	2016	2021	EDF014	ESS248	N	Triumph	1050	Sprint RS	1999	2003	EDF014	EST955	
Suzuki	700	750 Katana	1998	2006	EDF014	ESS650		Triumph	1050	Sprint ST / RS	2004	2009	EDF014	EST333	
Suzuki	750	Gsr 750 / Gsx-S 750	2011	2021	EDF014	ESS248	N	Triumph	1050	Tiger 1050 / Sport	2017	2020	EDF014	EST333P	
Suzuki	750	Gsxr 750	1996	2003	EDF014	ESS248		Triumph	1180	Trophy / SE	2013	2017	EDF014	ESC777	
Suzuki	750	Gsxr 750	2004	2005	EDF035	ESS248		Triumph	1200	Bonneville T120 / Black	2016	2019	EDF014	EST333P	N
Suzuki	750	Gsxr 750	2006	2014	EDF035	ESS035		Triumph	1200	Scrambler XC	2019	2020	EDF099	EST333P	N
Suzuki	750	Gsxr 750	2015	2021	EDF035	ESV004	N	Triumph	1200	Scrambler XE	2019	2019		EST333P	N
Suzuki	1000	DL 1000 / V-Storm	2002	2020	EDF014	ESS014	N	Triumph	1200	Speed Twin	2019	2020	EDF099	EST333P	N
Suzuki	1000	Gsxr 1000	2001	2004	EDF014	ESS248		Triumph	1200	Tiger 1200 Explorer	2012	2020	EDF014	ESC777	
Suzuki	1000	Gsxr 1000	2005	2006	EDF035	ESS035		Triumph	2294	Rocket III	2004	2007	EDF014	EST333	
Suzuki	1000	Gsxr 1000	2007	2008	EDF035	ESS014		Triumph	2294	Rocket III Classic	2007	2010	EDF014	EST333	
Suzuki	1000	Gsxr 1000	2009	2020	EDF035	ESV004	N	Triumph	2294	Rocket III Roadster	2010	2016	EDF014	EST333	
Suzuki	1000	Gsx-S 1000 / F / Abs	2015	2020	EDF035	ESV004	N	Yamaha	125	Yzf-R125	2008	2011	EDR15L		
Suzuki	1000	Katana	2020	2020	EDF035	ESV004	N	Yamaha	600	Fz6 Fazer	2004	2010	EDF016	ESY688	
Suzuki	1000	Sv 1000 / S	2003	2007	EDF014	ESS248		Yamaha	600	Fz6 R	2009	2017	EDF016	ESY688	
Suzuki	1000	TL 1000 R	1998	2003	EDF014	ESS014		Yamaha	600	R6 S Canada Version	2007	2009	EDF014	ESY688	
Suzuki	1000	TL 1000 S	1997	2001	EDF014	ESS248		Yamaha	600	R6 S Canada Version	2006	2006	EDR104	ESY688	
Suzuki	1250	Gsf 1250 Bandit	2001	2015	EDF014	ESS014		Yamaha	600	R6 S Europe Version	2006	2007	EDR104	ESY688	
Suzuki	1250	Gsx 1250 F/SA/ABS	2010	2016	EDF014	ESS014	N	Yamaha	600	R6 S Usa Version	2006	2009	EDF014	ESY688	
Suzuki	1300	B-King	2008	2011	EDF035	ES031		Yamaha	600	Xj6 Diversion	2009	2015	EDF016	ESY688	
Suzuki	1300	Hayabusa / Gsxr 1300	1999	2007	EDF014	ESS014	N	Yamaha	600	Yzf-R6	1994	2004	EDF014	ESY688	
Suzuki	1300	Hayabusa / Gsxr 1300	2008	2020	EDF041	ESS014	N	Yamaha	600	Yzf-R6	2017	2020	EDR015	ESV04A	N
Suzuki	1400	Gsx 1400	2001	2007	EDF014	ESS014		Yamaha	600	Yzf-R6	2005	2016	EDR104	ESY688	
Triumph	600	Daytona 600	2004	2005	EDF014	EST333		Yamaha	700	Mt-07 / Fz-07	2014	2020	EDF016	ESV04A	N
Triumph	600	Speed Four	2003	2004	EDF014			Yamaha	700	Xsr 700 Abs	2016	2020	EDF016	ESY688	N
Triumph	600	Speed Four	2005	2006	EDF014	EST333		Yamaha	800	Fz8	2011	2015	EDF016	ESY688	
Triumph	600	Speed Four	2003	2004		EST955		Yamaha	850	Fj-09 / Mt-09 Tracer	2015	2020	EDF016	ESV004	N
Triumph	650	Daytona 650	2004	2005	EDF014	EST333		Yamaha	850	Fz-09 / Mt-09 / SR (Not Fj-09)	2014	2020	EDF016	ESV04A	N
Triumph	675	675 Street Triple	2008	2016	EDF014	EST333		Yamaha	850	Niken	2019	2020	EDF016	ESY688	N
Triumph	675	675 Street Triple R / RX	2009	2016	EDF035	EST333		Yamaha	900	Tdm 900	2012	2014	EDF016	ESY695	
Triumph	675	Daytona 675	2006	2017	EDF035	EST333		Yamaha	900	Xsr 900 Abs	2016	2020	EDF016	ESY688	N
Triumph	675	Daytona 675 R	2011	2017	EDF011	EST333		Yamaha	950	Xv 950 Racer	2015	2016	EDF016		
Triumph	765	765 Street Triple R (Not Rs Version)	2017	2018	EDF011	EST333P	N	Yamaha	1000	Fz1 Fazer	2001	2005	EDF014	ESY688	
Triumph	765	765 Street Triple S (Not Rs Version)	2017	2019	EDF014	EST333P	N	Yamaha	1000	Fz1 Fazer	2006	2015	EDF016	ESY688	
Triumph	800	Tiger 800 / XC	2011	2014	EDF014	EST333		Yamaha	1000	Mt-10 / Fz-10	2016	2021	EDF016	ESV004	N
Triumph	800	Tiger 800 XC / XCX / XR / XRX	2015	2018	EDF014	EST333P	N	Yamaha	1000	Yzf R1	2002	2003	EDF014	ESY688	
Triumph	865	America	2004	2005	EDF014	EST955		Yamaha	1000	Yzf R1	1999	2001	EDF021	ESY688	
Triumph	865	America / LT	2006	2016	EDF014	EST333		Yamaha	1000	Yzf R1	2009	2014	EDR019	ESY688	
Triumph	865	Bonneville / SE / T100 / Black	2006	2015	EDF014	EST333		Yamaha	1000	Yzf R1	2004	2008	EDR104	ESY688	
Triumph	865	Scrambler	2006	2016	EDF014	EST333		Yamaha	1000	Yzf R1 / R1 M / R1 S	2015	2021	EDR015	ESV04A	N
Triumph	865	Speedmaster	2006	2016	EDF014	EST333		Yamaha	1200	Supertenera / Xt1200 ZE	2012	2020	EDF016	ESC777	N
Triumph	900	Scrambler / Street	2017	2018	EDF014	EST333P	N	Yamaha	1300	Fjr 1300	2003	2003	EDF014	ESC777	
Triumph	900	Street Cup	2017	2018	EDF014	EST333P	N	Yamaha	1300	Fjr 1300	2004	2020	EDF016	ESC777	N
Triumph	900	Street Twin	2016	2019	EDF014	EST333P	N	Yamaha	1300	Xjr 1300 / Racer	2004	2016	EDF016	ESC777	
Triumph	900	Thruxton	2004	2015	EDF014	EST333		Yamaha	1300	Xjr1300	2004	2014	EDF016	ESC777	
Triumph	900	Thruxton R	2016	2019	EDF099	EST333P	N	Yamaha	1300	Xjr1300	1995	2003		ESC777	
Triumph	900	Thruxton Steve Mcqueen Se	2012	2012	EDF014	EST333		Yamaha	1700	Mt-01	2004	2009	EDR104	ESC777	
Triumph	900	Thruxton/Street Cup	2016	2018	EDF014	EST333P	N	Yamaha	1700	V-Max	2009	2020	EDR104	ESC777	N

- BRAKE/CLUTCH MASTER CYLINDERS
- ACCESSORIES SPARE PARTS
- CNC-WORKED FLUID RESERVOIR
- FULL CLUTCH
- HYDRAULIC-CLUTCH TRANFORMATION KIT
- LEVER
- THROTTLE CONTROL
- BRAKE CALIPER
- RACING KIT
- BUTTON PANEL
- LEVER GUARD
- CLIP-ON
- STREET RACING REARSET
- FUEL CAPS
- STEERING NUT
- CRASH PADS
- PADDOCK STAND
- MIRROR COVERS
- REAR-VIEW MIRRORS
- FOG LIGHTS KIT
- HANDLEBARS ACCESSORIES
- HANDLEBARS

Leve a controllo remoto integrato

Brake lever with integrated remote adjuster



Descrizione
Description

Leva freno a controllo remoto integrato per pompe OEM
Brake lever with integrated remote adjuster for OEM master cylinders

Opzioni leva
Lever options

RST

Opzioni supporto
Holder options

35 mm

60 mm

Colori / Colours

N ●
nero - black

O ●
arancione
orange

Y ●
oro - gold

B ●
blu - blue

R ●
rosso - red

S ●
argento - silver

G ●
verde - green

Codice
Reference

Descrizione
Description

Opzioni leva
Lever options

LV018	Leva freno snodata, per pompe radiali Nissin Folding brake lever, for Nissin radial master cylinders	RST
LV019		
LV020		
LV021	Leva freno snodata con registro integrato, per pompe radiali Nissin Folding brake lever with integrated adjuster, for Nissin radial master cylinders	RST
LV022		

Colori / Colours

N ●
nero - black

O ●
arancione
orange

Y ●
oro - gold

B ●
blu - blue

R ●
rosso - red

S ●
argento - silver

G ●
verde - green

T ●
titanio - titanium

Codice
Reference

Descrizione
Description

Opzioni leva
Lever options

Opzioni supporto
Holder options

RA001	Leva freno a controllo remoto integrato per pompe OEM / Brake lever with integrated 90° remote adjuster for OEM master cylinders	RST	35 mm
RA002	Leva freno a controllo remoto integrato per pompe OEM / Brake lever with integrated 90° remote adjuster for OEM master cylinders		60 mm

Colori / Colours

N ●
nero - black

O ●
arancione
orange

Y ●
oro - gold

B ●
blu - blue

R ●
rosso - red

S ●
argento - silver

G ●
verde - green

- BRAKE/CLUTCH MASTER CYLINDERS
- ACCESSORIES SPARE PARTS
- CNC-WORKED FLUID RESERVOIR
- FULL CLUTCH
- HYDRAULIC-CLUTCH TRANSFORMATION KIT
- LEVER
- THROTTLE CONTROL
- BRAKE CALIPER
- RACING KIT
- BUTTON PANEL
- LEVER GUARD
- CLIP-ON
- STREET RACING REARSET
- FUEL CAPS
- STEERING NUT
- CRASH PADS
- PADDOCK STAND
- MIRROR COVERS
- REAR-VIEW MIRRORS
- FOG LIGHTS KIT
- HANDLEBARS ACCESSORIES
- HANDLEBARS

Applicazioni / Application list

Marca Brand	Cc	Modello Model	Da From	A To	Codice Code	Novità New	Marca Brand	Cc	Modello Model	Da From	A To	Codice Code	Novità New
APRILIA	1000	RSV R	2004	2008	RA001		DUCATI	850	848 EVO USA	2011	2011	RA001	N
APRILIA	1000	RSV R DREAM	2004	2008	RA001		DUCATI	850	848 EVO	2012	2012	RA001	N
APRILIA	1000	RSV R FACTORY	2004	2008	RA001		DUCATI	850	848 EVO CORSE SE	2012	2012	RA001	N
APRILIA	1000	RSV4 FACTORY - SBK RACING	2009	2010	RA001	N	DUCATI	850	848 EVO CORSE SE USA	2012	2012	RA001	N
APRILIA	1000	RSV4 R	2009	2010	RA001	N	DUCATI	850	848 EVO USA	2012	2012	RA001	N
APRILIA	1000	RSV4 APRC R	2011	2012	RA001	N	DUCATI	900	899 PANIGALE ABS USA	2014	2015	RA002	
APRILIA	1000	RSV4 FACTORY APRC STD - SE	2011	2012	RA001	N	DUCATI	900	899 PANIGALE ABS	2014	2014	RA002	
APRILIA	1000	RSV4 APRC R ABS	2013	2014	RA001	N	DUCATI	900	899 ABS THA	2015	2015	RA002	
APRILIA	1000	RSV4 FACTORY APRC ABS	2013	2014	RA001	N	DUCATI	959	959 PANIGALE ABS	2016	2019	RA002	N
APRILIA	1000	RSV4 RACING FACTORY LE	2015	2015	RA001	N	DUCATI	959	959 PANIGALE ABS THA	2016	2019	RA002	N
APRILIA	1000	RSV4 RR	2015	2015	RA001	N	DUCATI	959	959 PANIGALE ABS BRA	2017	2018	RA002	N
APRILIA	1000	RSV4 RR RACER PACK	2015	2015	RA001	N	DUCATI	959	959 PANIGALE ABS	2018	2019	RA002	N
APRILIA	1000	RSV4 RACING FACTORY LE	2016	2016	RA001	N	DUCATI	959	959 PANIGALE ABS USA	2018	2019	RA002	N
APRILIA	1000	RSV4 RR	2016	2016	RA001	N	DUCATI	959	PANIGALE CORSE	2018	2019	RA002	N
APRILIA	1000	RSV4 RACING FACTORY LE	2017	2017	RA001	N	DUCATI	959	PANIGALE CORSE U	2018	2019	RA002	N
APRILIA	1000	RSV4 RR	2017	2018	RA001	N	DUCATI	998	999	2003	2003	RA001	N
APRILIA	1000	RSV4 RACING FACTORY ABS	2018	2018	RA001	N	DUCATI	998	999 R	2003	2003	RA001	N
APRILIA	1000	RSV4 RR EURO 4 ABS	2019	2019	RA001	N	DUCATI	998	999 S	2003	2003	RA001	N
APRILIA	1100	TUONO V4 FACTORY	2017	2017	RA001	N	DUCATI	998	999	2004	2004	RA001	N
APRILIA	1100	TUONO V4 RR	2017	2018	RA001	N	DUCATI	998	999 R	2004	2004	RA001	N
APRILIA	1100	TUONO V4 RF ABS	2018	2018	RA001	N	DUCATI	998	999 S	2004	2004	RA001	N
APRILIA	1100	RSV4 RACING FACTORY EURO 4 ABS	2019	2019	RA001	N	DUCATI	998	999	2005	2005	RA001	N
APRILIA	1100	TUONO V4 FACTORY SUPERPOLE EURO 4	2019	2019	RA001	N	DUCATI	998	999 R	2005	2005	RA001	N
APRILIA	1100	TUONO V4 RR EURO 4 ABS	2019	2019	RA001	N	DUCATI	998	999 R USA	2005	2005	RA001	N
BMW	1000	S1000 RR	2009	2014	LV022		DUCATI	998	999 S	2005	2005	RA001	N
BMW	1000	HP4	2012	2017	LV022	N	DUCATI	998	999 S USA	2005	2005	RA001	N
BUELL	984	XB9 S LIGHTNING	2004	2007	LV021		DUCATI	998	999 USA	2005	2005	RA001	N
BUELL	1200	XB12 S LIGHTNING	2004	2007	LV021		DUCATI	998	999	2006	2006	RA001	N
BUELL	1200	XB9 S FIREBOLT	2004	2007	LV021		DUCATI	998	999 R	2006	2006	RA001	N
DUCATI	748	749	2003	2003	RA001	N	DUCATI	998	999 R USA	2006	2006	RA001	N
DUCATI	748	749 S	2003	2003	RA001	N	DUCATI	998	999 R XEROX	2006	2006	RA001	N
DUCATI	748	749 DARK USA	2004	2004	RA001	N	DUCATI	998	999 R XEROX USA	2006	2006	RA001	N
DUCATI	748	749 S	2004	2004	RA001	N	DUCATI	998	999 S	2006	2006	RA001	N
DUCATI	748	749 DARK USA	2005	2005	RA001	N	DUCATI	998	999 S USA	2006	2006	RA001	N
DUCATI	748	749 R USA	2005	2005	RA001	N	DUCATI	998	999 USA	2006	2006	RA001	N
DUCATI	748	749 S	2005	2005	RA001	N	DUCATI	998	999 S AMA REPLICIA	2007	2007	RA001	N
DUCATI	748	749 S USA	2005	2005	RA001	N	DUCATI	1000	MONSTER S4RS	2006	2008	RA001	
DUCATI	748	749 DARK USA	2006	2006	RA001	N	DUCATI	1000	MONSTER S4RS USA	2006	2006	RA001	N
DUCATI	748	749 R USA	2006	2006	RA001	N	DUCATI	1000	MONSTER S4R	2007	2008	RA001	
DUCATI	748	749 S	2006	2006	RA001	N	DUCATI	1000	MONSTER S4R USA	2007	2007	RA001	N
DUCATI	748	749 S USA	2006	2006	RA001	N	DUCATI	1000	MONSTER S4RS USA	2007	2007	RA001	N
DUCATI	749	749 R	2004	2006	RA001		DUCATI	1000	MONSTER S4R USA	2008	2008	RA001	N
DUCATI	848	848 EVO	2013	2013	RA001	N	DUCATI	1000	MONSTER S4RS TRICOLORE	2008	2008	RA001	N
DUCATI	848	848 EVO CORSE SE	2013	2013	RA001	N	DUCATI	1000	MONSTER S4RS TRICOLORE USA	2008	2008	RA001	N
DUCATI	848	848 EVO CORSE SE USA	2013	2013	RA001	N	DUCATI	1000	MONSTER S4RS USA	2008	2008	RA001	N
DUCATI	848	848 EVO USA	2013	2013	RA001	N	DUCATI	1000	PANIGALE V4 R	2019	2019	RA002	N
DUCATI	850	848	2008	2008	RA001	N	DUCATI	1100	MONSTER S	2009	2013	RA001	
DUCATI	850	848 USA	2008	2008	RA001	N	DUCATI	1100	MONSTER 1100	2009	2009	RA001	N
DUCATI	850	848	2009	2009	RA001	N	DUCATI	1100	MONSTER 1100 S	2009	2009	RA001	N
DUCATI	850	848 USA	2009	2009	RA001	N	DUCATI	1100	MONSTER 1100 S USA	2009	2009	RA001	N
DUCATI	850	848	2010	2010	RA001	N	DUCATI	1100	MONSTER 1100 USA	2009	2009	RA001	N
DUCATI	850	848 HAYDEN	2010	2010	RA001	N	DUCATI	1100	MONSTER 1100	2010	2010	RA001	N
DUCATI	850	848 USA	2010	2010	RA001	N	DUCATI	1100	MONSTER 1100 ABS	2010	2010	RA001	N
DUCATI	850	848 EVO	2011	2011	RA001	N	DUCATI	1100	MONSTER 1100 ABS USA	2010	2010	RA001	N



Marca Brand	Cc	Modello Model	Da From	A To	Codice Code	Novità New	Marca Brand	Cc	Modello Model	Da From	A To	Codice Code	Novità New
DUCATI	1100	MONSTER 1100 S	2010	2010	RA001	N	DUCATI	1285	1299 ABS USA	2015	2015	RA002	
DUCATI	1100	MONSTER 1100 S ABS	2010	2010	RA001	N	DUCATI	1285	1299S ABS	2015	2015	RA002	
DUCATI	1100	MONSTER 1100 S ABS USA	2010	2010	RA001	N	DUCATI	1299	1299 ABS BRASIL	2016	2018	RA002	N
DUCATI	1100	MONSTER 1100 S USA	2010	2010	RA001	N	DUCATI	1299	1299 S ABS BRASIL	2016	2018	RA002	N
DUCATI	1100	MONSTER 1100 USA	2010	2010	RA001	N	DUCATI	1299	SUPERBIKE 1299 ABS BRASIL	2016	2016	RA002	
DUCATI	1100	MONSTER EVO	2011	2019	RA001		DUCATI	1299	SUPERBIKE 1299S ABS BRASIL	2016	2016	RA002	
DUCATI	1100	MONSTER 1100 EVO ABS	2012	2012	RA001	N	DUCATI	1299	1299 R	2017	2018	RA002	N
DUCATI	1100	MONSTER 1100 DIESEL	2013	2013	RA001	N	DUCATI	1299	1299 ABS	2017	2017	RA002	
DUCATI	1100	MONSTER 1100 DIESEL USA	2013	2013	RA001	N	DUCATI	1299	1299 ABS USA	2017	2017	RA002	
DUCATI	1100	MONSTER 1100 EVO ABS	2013	2013	RA001	N	DUCATI	1299	1299 ABS USA	2017	2017	RA002	
DUCATI	1100	MONSTER 1100 EVO ABS USA	2013	2013	RA001	N	DUCATI	1299	1299 S 90 ANNIVERSARIO	2017	2017	RA002	
DUCATI	1100	MONSTER 1100 EVO ANNIVERSARY	2013	2013	RA001	N	DUCATI	1299	1299S ABS	2017	2017	RA002	
DUCATI	1100	MONSTER 1100 EVO ANNIVERSARY	2013	2013	RA001	N	DUCATI	1299	SUPERBIKE 1299 ABS	2017	2017	RA002	
DUCATI	1100	PANIGALE V4	2018	2019	RA002	N	DUCATI	1299	SUPERBIKE 1299 ABS USA	2017	2017	RA002	
DUCATI	1100	PANIGALE V4 S	2018	2019	RA002	N	DUCATI	1299	SUPERBIKE 1299S 90 ANNIVERSARIO	2017	2017	RA002	
DUCATI	1100	PANIGALE V4 S USA	2018	2019	RA002	N	DUCATI	1299	SUPERBIKE 1299S ABS	2017	2017	RA002	
DUCATI	1100	PANIGALE V4 THAILAND	2018	2019	RA002	N	DUCATI	1299	SUPERBIKE 1299S ABS USA	2017	2017	RA002	
DUCATI	1100	PANIGALE V4 USA	2018	2019	RA002	N	DUCATI	1300	1299 ABS	2016	2016	RA002	
DUCATI	1100	PANIGALE V4S THAILAND	2018	2019	RA002	N	DUCATI	1300	1299 ABS USA	2016	2016	RA002	
DUCATI	1100	PANIGALE V4 SPEICALE	2019	2019	RA002	N	DUCATI	1300	1299 S ABS	2016	2016	RA002	
DUCATI	1100	PANIGALE V4S CORSE	2019	2019	RA002	N	DUCATI	1300	SUPERBIKE 1299 ABS	2016	2016	RA002	
DUCATI	1200	1199 PANIGALE ABS	2012	2014	RA002		DUCATI	1300	SUPERBIKE 1299 ABS USA	2016	2016	RA002	
DUCATI	1200	1199 PANIGALE ABS US	2012	2014	RA002		DUCATI	1300	SUPERBIKE 1299S ABS	2016	2016	RA002	
DUCATI	1200	1199 PANIGALE S ABS	2012	2014	RA002		DUCATI	1300	SUPERBIKE 1299S ABS USA	2016	2016	RA002	
DUCATI	1200	1199 PANIGALE	2012	2013	RA002		KAWASAKI	650	KLE VERSYS ABS FFF-FGF	2015	2016	LV021	
DUCATI	1200	1199 PANIGALE S TRIC	2012	2013	RA002		KAWASAKI	650	KLE VERSYS EFF-EGF	2015	2016	LV021	
DUCATI	1200	1199 PANIGALE S USA	2012	2013	RA002		KAWASAKI	650	VULCAN S ABS BFF-BGF-BGFA	2015	2016	LV021	
DUCATI	1200	1199 PANIGALE USA	2012	2013	RA002		KAWASAKI	650	VULCAN S AFF-AGF-AGFA	2015	2016	LV021	
DUCATI	1200	1199 PANIGALE S	2012	2013	RA002		KAWASAKI	650	KLE VERSYS ABS FHF-FHFA-FJF-FJFA	2017	2018	LV021	N
DUCATI	1200	1199 PANIGALE R	2013	2013	RA002		KAWASAKI	650	NINJA 650 ABS KHf-KHFA-KJf-KJFA	2017	2018	LV021	N
DUCATI	1200	1199 PANIGALE R USA	2013	2013	RA002		KAWASAKI	650	VULCAN S ABS DHf-DHFA-DJf-DJFA	2017	2018	LV021	N
DUCATI	1200	MONSTER 1200 S	2014	2020	RA002	N	KAWASAKI	650	VULCAN S CAFE' ABS EHf-EJf-EKf	2017	2019	LV021	N
DUCATI	1200	MONSTER 1200 S USA	2014	2019	RA002	N	KAWASAKI	650	Z650 ABS HHf-HJf-HKf	2017	2019	LV021	N
DUCATI	1200	1199 PANIGALE ABS BR	2014	2014	RA002		KAWASAKI	650	KLE VERSYS KFf-FKFA-FLf-FLFA	2019	2020	LV021	N
DUCATI	1200	1199 PANIGALE R USA	2014	2014	RA002		KAWASAKI	650	NINJA 650 ABS KKf-KKFA	2019	2019	LV021	N
DUCATI	1200	1199 PANIGALE S ABS	2014	2014	RA002		KAWASAKI	650	VULCAN S DKf-DKFA-DLf-DLFA	2019	2020	LV021	N
DUCATI	1200	PANIGALE R	2014	2014	RA002		KAWASAKI	750	Z750 ABS M7f-MAf-MAS	2007	2010	LV021	
DUCATI	1200	MONSTER 1200 S STRIPES	2015	2016	RA002		KAWASAKI	750	Z750 L7f-LAf-LAS	2007	2010	LV021	
DUCATI	1200	MONSTER 1200 S STRIPES USA	2015	2016	RA002		KAWASAKI	750	Z750R ABS PBF-PCF	2011	2012	LV021	
DUCATI	1200	1199 PANIGALE ABS	2015	2015	RA002		KAWASAKI	750	Z750R NBF-NCF	2011	2012	LV021	
DUCATI	1200	1199 PANIGALE ABS BR	2015	2015	RA002		KAWASAKI	750	Z750 ABS MBf-MCF	2011	2012	LV021	
DUCATI	1200	899 PANIGALE ABS	2015	2015	RA002		KAWASAKI	750	Z750 LBF-LCF	2011	2012	LV021	
DUCATI	1200	PANIGALE R	2015	2015	RA002		KAWASAKI	800	Z800 ABS BDS-BEf-BFf-BGF	2013	2016	LV021	
DUCATI	1200	PANIGALE R USA	2015	2015	RA002		KAWASAKI	800	Z800 ADS-AEf-AFf-AGf	2013	2016	LV021	
DUCATI	1200	MONSTER 1200	2016	2020	RA002	N	KAWASAKI	800	Z800 E ABS DdS-DEf-DFf-DGf-DGFA	2013	2016	LV021	
DUCATI	1200	MONSTER 1200 R	2016	2019	RA002	N	KAWASAKI	800	Z800 E CDS-CEf-CFf-CGf-CGFA	2013	2016	LV021	
DUCATI	1200	MONSTER 1200 R USA	2016	2019	RA002	N	KAWASAKI	800	Z800 E ABS SPECIAL EDITION FGF	2016	2016	LV021	
DUCATI	1200	PANIGALE R	2016	2016	RA002		KAWASAKI	800	Z800 E SPECIAL EDITION EGF	2016	2016	LV021	
DUCATI	1200	PANIGALE R USA	2016	2016	RA002		KAWASAKI	900	Z900 ABS BHf	2017	2017	LV021	
DUCATI	1200	PANIGALE R	2017	2017	RA002		KAWASAKI	900	Z900RS CAFE EJf-EKf-ELFA	2018	2020	LV021	N
DUCATI	1200	PANIGALE R USA	2017	2017	RA002		KAWASAKI	900	Z900RS CJf-CJFA-CJFB	2018	2018	LV021	N
DUCATI	1200	MONSTER 1200 S	2019	2019	RA002	N	KAWASAKI	900	Z900 A2 DJf-DKf	2018	2019	LV021	N
DUCATI	1285	1299 ABS	2015	2015	RA002		KAWASAKI	900	Z900 BJf-BKf	2018	2019	LV021	N
DUCATI	1285	1299 ABS USA	2015	2015	RA002		KAWASAKI	900	Z900RS CKf-CKFA-CKFB	2019	2019	LV021	N

- BRAKE/CLUTCH MASTER CYLINDERS
- ACCESSORIES SPARE PARTS
- CNC-WORKED FLUID RESERVOIR
- FULL CLUTCH
- HYDRAULIC-CLUTCH TRANFORMATION KIT
- LEVER
- THROTTLE CONTROL
- BRAKE CALIPER
- RACING KIT
- BUTTON PANEL
- LEVER GUARD
- CLIP-ON
- STREET RACING REARSET
- FUEL CAPS
- STEERING NUT
- CRASH PADS
- PADDOCK STAND
- MIRROR COVERS
- REAR-VIEW MIRRORS
- FOG LIGHTS KIT
- HANDLEBARS ACCESSORIES
- HANDLEBARS

Marca Brand	Cc	Modello Model	Da From	A To	Codice Code	Novità New	Marca Brand	Cc	Modello Model	Da From	A To	Codice Code	Novità New
KAWASAKI	900	Z900RS CLF-CLFA-CLFB	2020	2020	LV021	N	SUZUKI	1000	GSX-R1000A/RZ L8	2018	2018	LV022	N
KAWASAKI	1000	Z1000 ABS C7F-C9F	2007	2009	LV021		SUZUKI	1000	GSX-S1000A L8	2018	2018	LV022	N
KAWASAKI	1000	Z1000 B7F-B9F	2007	2009	LV021		SUZUKI	1000	GSX-S1000FA L8	2018	2018	LV022	N
KAWASAKI	1000	Z1000 ABS EAF-EBF-ECF-ECFA	2010	2012	LV021		SUZUKI	1000	GSX-R1000A/RA/RZAL L9	2019	2019	LV022	N
KAWASAKI	1000	Z1000 DAF-DAS-DBF-DCF-DCFA	2010	2012	LV021		SUZUKI	1000	GSX-S 1000FA L9	2019	2019	LV022	N
KAWASAKI	1000	Z1000 ABS EDF-EDFA	2013	2013	LV021		SUZUKI	1000	GSX-S1000A L9	2019	2019	LV022	N
KAWASAKI	1000	Z1000 DDF-DDFA	2013	2013	LV021		SUZUKI	1000	GSX-S1000SRQ/TQM0 KATANA	2019	2019	LV022	N
KTM	990	SUPER DUKE	2005	2015	RA001		SUZUKI	1300	GSX1300BK B-KING K8-LO	2008	2010	LV022	
KTM	990	SUPER DUKE R	2007	2017	RA001		TRIUMPH	675	DAYTONA	2006	2013	LV022	
KTM	1190	RC8	2008	2015	RA001		TRIUMPH	675	DAYTONA R	2011	2013	RA001	
KTM	1190	RC8 R	2009	2014	RA001		TRIUMPH	675	STREET TRIPLE	2012	2015	LV022	
MOTO GUZZI	1130	TNT R160	2010	2014	RA001	N	TRIUMPH	1050	SPEED TRIPLE	2008	2009	LV022	
MOTO GUZZI	1130	TNT R	2011	2014	RA001	N	TRIUMPH	1050	SPEED TRIPLE	2010	2015	RA001	
MOTO GUZZI	1225	MGS-01 CORSA	2004	2014	RA001		YAMAHA	600	YZF-R6	2017	2017	LV022	
MOTO GUZZI	1200	CORSARO	2007	2017	RA001		YAMAHA	600	YZF-R6	2018	2018	LV022	N
MOTO GUZZI	1200	CORSARO CARBON	2007	2017	RA001		YAMAHA	600	YZF-R6	2019	2019	LV022	N
MOTO GUZZI	1200	CORSARO VELOCE	2007	2017	RA001		YAMAHA	1000	YZF-R1	2015	2015	LV022	
MOTO GUZZI	1200	GRANPASSO	2008	2018	RA001		YAMAHA	1000	YZF-R1M	2015	2016	LV022	
SUZUKI	600	GSX-R600K4-K5	2004	2005	LV022		YAMAHA	1000	YZF-R1	2016	2016	LV022	
SUZUKI	600	GSX-R600K6-K7	2006	2007	LV022		YAMAHA	1000	YZF-R1	2017	2018	LV022	N
SUZUKI	600	GSX-R600 K8-LO	2008	2010	LV022		YAMAHA	1000	YZF-R1M	2017	2017	LV022	
SUZUKI	600	GSX-R600L1	2011	2011	LV022		YAMAHA	1000	YZF-R1M	2018	2018	LV022	N
SUZUKI	600	GSX-R600L2	2012	2012	LV022		YAMAHA	1000	YZF-R1M	2019	2019	LV022	N
SUZUKI	600	GSX-R600L3	2013	2013	LV022								
SUZUKI	600	GSX-R600L4	2014	2014	LV022								
SUZUKI	600	GSX-R600 L5	2015	2015	LV022	N							
SUZUKI	600	GSX-R600 L6	2016	2016	LV022	N							
SUZUKI	600	GSX-R600 L7	2017	2017	LV022	N							
SUZUKI	750	GSX-R750K4-K5	2004	2005	LV022								
SUZUKI	750	GSX-R750K6-K7	2006	2007	LV022								
SUZUKI	750	GSX-R750 K8-LO	2008	2010	LV022								
SUZUKI	750	GSX-R750 L1	2011	2011	LV022								
SUZUKI	750	GSX-R750 L2	2012	2012	LV022								
SUZUKI	750	GSX-R750 L3	2013	2013	LV022								
SUZUKI	750	GSX-R750 L4	2014	2014	LV022								
SUZUKI	750	GSX-R750Z(UF) L4	2014	2014	LV022								
SUZUKI	750	GSX-R750 L5	2015	2015	LV022	N							
SUZUKI	750	GSX-R750 L6	2016	2016	LV022	N							
SUZUKI	750	GSX-R750 L7	2017	2017	LV022	N							
SUZUKI	1000	GSX-R1000 K5-K6	2005	2006	LV022								
SUZUKI	1000	GSX-R1000 K7-K8	2007	2008	LV022								
SUZUKI	1000	GSX-R1000 K9-LO	2009	2010	LV022								
SUZUKI	1000	GSX-R1000 L1	2011	2011	LV022								
SUZUKI	1000	GSX-R1000 L2	2012	2012	LV022								
SUZUKI	1000	GSX-R1000 L3	2013	2013	LV022								
SUZUKI	1000	GSX-R1000 L4	2014	2014	LV022								
SUZUKI	1000	GSX-R1000Z L4	2014	2014	LV022								
SUZUKI	1000	GSX-R1000 L5	2015	2015	LV022	N							
SUZUKI	1000	GSX-R1000A ABS L5	2015	2015	LV022	N							
SUZUKI	1000	GSX-R1000(A) L6	2016	2016	LV022	N							
SUZUKI	1000	GSX-S1000 L6	2016	2016	LV022								
SUZUKI	1000	GSX-S1000F L6	2016	2016	LV022								
SUZUKI	1000	GSX-R1000A L7	2017	2017	LV022	N							
SUZUKI	1000	GSX-R1000R(Z)L7	2017	2017	LV022	N							

- BRAKE/CLUTCH MASTER CYLINDERS
- ACCESSORIES SPARE PARTS
- CNC-WORKED FLUID RESERVOIR
- FULL CLUTCH
- HYDRAULIC-CLUTCH TRANFORMATION KIT
- LEVER
- THROTTLE CONTROL
- BRAKE CALIPER
- RACING KIT
- BUTTON PANEL
- LEVER GUARD
- CLIP-ON
- STREET RACING REARSET
- FUEL CAPS
- STEERING NUT
- CRASH PADS
- PADDOCK STAND
- MIRROR COVERS
- REAR-VIEW MIRRORS
- FOG LIGHTS KIT
- HANDLEBARS ACCESSORIES
- HANDLEBARS



RA003



RA004



Codice Reference	Descrizione Description	Opzioni supporto Holder options
RA003	Controllo remoto integrato dritto, per pompe Accossato e radiali Brembo <i>Integrated straight remote adjuster, for Accossato and Brembo radial master cylinders</i>	35 mm
RA004	Controllo remoto integrato a 90° per pompe Accossato, equivalente del codice Brembo X9849B0 <i>Integrated 90° remote adjuster for Accossato master cylinders, comparable of Brembo code X9849B0</i>	60 mm

■ Ricambi supporto / Spare-part holder

Codice Reference	Descrizione Description	Altezza Available height
RS001	Ricambio supporto corto <i>Short spare-part holder</i>	35 mm
RS002	Ricambio supporto lungo <i>Long spare-part holder</i>	60 mm

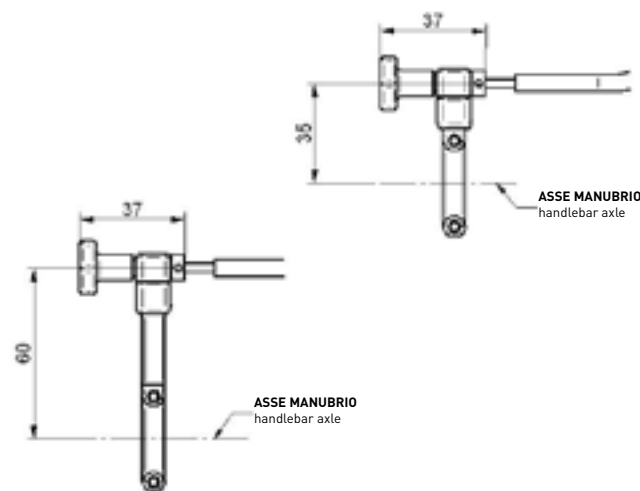

Codice Reference	Descrizione Description
RS005	Ricambio perno fissaggio controllo remoto per RA003 / <i>Spare-part connection pin RA003</i>
RS006	Ricambio guaina controllo remoto per RA003 e RA004 / <i>Spare-part plastic tubing for RA003 & RA004</i>
RS007	Ricambio Guaina con filo per RA001 e RA002 / <i>Spare-part plastic tubing+metal wire for RA001 & RA002</i>
RS008	Ricambio Guaina con filo per LV007 / <i>Spare-part plastic tubing+metal wire for LV007</i>
RS009	Ricambio Guaina con filo per LV021 - LV022 / <i>Spare-part plastic tubing+metal wire for LV021 - LV022</i>
RS010	Ricambio Guaina con filo per RA003 / <i>Spare-part plastic tubing+metal wire for RA003</i>

BRAKE/CLUTCH
MASTER CYLINDERS
 ACCESSORIES
SPARE PARTS
 CNC-WORKED FLUID
RESERVOIR
 FULL CLUTCH
 HYDRAULIC-CLUTCH
TRANFORMATION KIT
 LEVER
 THROTTLE CONTROL
 BRAKE CALIPER
 RACING KIT
 BUTTON PANEL
 LEVER GUARD
 CLIP-ON
 STREET RACING
REARSET
 FUEL CAPS
 STEERING NUT
 CRASH PADS
 PADDOCK STAND
 MIRROR COVERS
 REAR-VIEW MIRRORS
 FOG LIGHTS KIT
 HANDLEBARS
ACCESSORIES
 HANDLEBARS

LEVE MOTORIZZATE

MECHANIZED LEVERS



BRAKE/CLUTCH
MASTER CYLINDERS

ACCESSORIES
SPARE PARTS

CNC-WORKED FLUID
RESERVOIR

FULL CLUTCH

HYDRAULIC-CLUTCH
TRANSFORMATION KIT

LEVER

THROTTLE CONTROL

BRAKE CALIPER

RACING KIT

BUTTON PANEL

LEVER GUARD

CLIP-ON

STREET RACING
REARSET

FUEL CAPS

STEERING NUT

CRASH PADS

Paddock STAND

MIRROR COVERS

REAR-VIEW MIRRORS

FOG LIGHTS KIT

HANDLEBARS
ACCESSORIES

HANDLEBARS

Codice Reference	Descrizione Description	Colori Colours
LM002	Leva freno a controllo elettronico per pompe Accossato e Brembo (no RCS) <i>Brake lever with electronic control, for Accossato and Brembo master cylinders (no RCS)</i>	N ● nero - black

Spiegazione
Explanation

Dispositivo brevettato accossato. le leve tradizionali col pomello di regolazione manuale risultano tutt'altro che semplici da regolare sul rettilineo, a 300km/h. con le leve a controllo elettronico invece, è sufficiente agire sui 2 pulsanti, per ottenere una regolazione semplice e perfetta per le esigenze di ogni pilota.

Device patented by Accossato. Traditional levers have manual adjusting knob: not that easy for the driver to adjust, when riding at 300Km/h. On the contrary, with electronic-control levers adjustment is only about pushing the 2 installed buttons: easy and fast. Perfect for all tastes.

Leva freno per pompe Brembo RCS
Brake lever for Brembo rcs master cylinder



Codice Reference	Descrizione Description
LV007	Leva freno per pompe Brembo RCS 19x18 CNC <i>Brake lever for Brembo RCS CNC master cylinder 19x18</i>

- BRAKE/CLUTCH MASTER CYLINDERS
- ACCESSORIES SPARE PARTS
- CNC-WORKED FLUID RESERVOIR
- FULL CLUTCH
- HYDRAULIC-CLUTCH TRANFORMATION KIT
- LEVER
- THROTTLE CONTROL
- BRAKE CALIPER
- RACING KIT
- BUTTON PANEL
- LEVER GUARD
- CLIP-ON
- STREET RACING REARSET
- FUEL CAPS
- STEERING NUT
- CRASH PADS
- Paddock STAND
- MIRROR COVERS
- REAR-VIEW MIRRORS
- FOG LIGHTS KIT
- HANDLEBARS ACCESSORIES
- HANDLEBARS

COMANDO GAS RAPIDO

QUICK THROTTLE CONTROL



- BRAKE/CLUTCH MASTER CYLINDERS
- ACCESSORIES SPARE PARTS
- CNC-WORKED FLUID RESERVOIR
- FULL CLUTCH
- HYDRAULIC-CLUTCH TRANSFORMATION KIT
- LEVER
- THROTTLE CONTROL
- BRAKE CALIPER
- RACING KIT
- BUTTON PANEL
- LEVER GUARD
- CLIP-ON
- STREET RACING REARSET
- FUEL CAPS
- STEERING NUT
- CRASH PADS
- Paddock STAND
- MIRROR COVERS
- REAR-VIEW MIRRORS
- FOG LIGHTS KIT
- HANDLEBARS ACCESSORIES
- HANDLEBARS



ACCOSATO®

Codice Reference	Descrizione Description
MY001	Comando gas in ergal senza cavi, con manopole GR001 incluse <i>Ergal-made throttle control, without cables, provided with GR001 grips</i>
MY002	Comando gas in ergal completo di cavi (specificare codice) e manopole GR001 <i>Ergal-made throttle control, provided with cables (specify reference) and GR001 grips</i>
MY003	Comando gas in ergal senza cavi, con manopole GR002 incluse <i>Ergal-made throttle control, without cables, provided with GR002 grips</i>
MY004	Comando gas in ergal completo di cavi (specificare codice) e manopole GR002 <i>Ergal-made throttle control, provided with cables (specify reference) and GR002 grips</i>
MY007	Comando gas in ergal senza cavi, con manopole GR006 incluse <i>Ergal-made throttle control, without cables, provided with GR006 grips</i>
MY008	Comando gas in ergal completo di cavi (specificare codice) e manopole GR006 <i>Ergal-made throttle control, provided with cables (specify reference) and GR006 grips</i>

Colori manopole e calotte / Caps and grips available in



Codice Reference	Descrizione Description
MY005	Comando gas specifico per Bmw, senza cavi (usa cavi originali), con manopole GR001 incluse <i>Bmw-specific throttle control, without cables (fits original cables only), provided with GR001 grips</i>
MY006	Comando gas specifico per Bmw, senza cavi (usa cavi originali), con manopole GR002 incluse <i>Bmw-specific throttle control, without cables (fits original cables only), provided with GR002 grips</i>
MY009	Comando gas specifico per Bmw, senza cavi (usa cavi originali), con manopole GR006 incluse <i>Bmw-specific throttle control, without cables (fits original cables only), provided with GR006 grips</i>

Colori calotte / Caps available in







**Contenuto
Contents**

I comandi gas bicavo (no Bmw) vengono forniti completi di 3 cam: Ø 40 - 43 - 45
Double-cable throtte controls (no Bmw) are provided with 3 cams: Ø 40 - 43 - 45
BMW solo Ø 47 / Only cam Ø 47 for BMW

Note: non compatibili con Ryde by wire - *Not compatible with "ryde by wire"*

**Accessori
Spare parts**

CAM40	Cam Interna di ricambio per comando gas Accossato, diametro 40mm <i>Inner Cam for Accossato throttle control, diameter 40mm</i>		CAM47	Cam Interna di ricambio per comando gas Accossato, diametro 47mm <i>Inner Cam for Accossato throttle control, diameter 47mm</i>	
CAM43	Cam Interna di ricambio per comando gas Accossato, diametro 43mm <i>Inner Cam for Accossato throttle control, diameter 43mm</i>		RC054	Tube comando gas <i>Throttle control tube</i>	
CAM45	Cam Interna di ricambio per comando gas Accossato, diametro 45mm <i>Inner Cam for Accossato throttle control, diameter 45mm</i>				

BRAKE/CLUTCH MASTER CYLINDERS
ACCESSORIES SPARE PARTS
CNC-WORKED FLUID RESERVOIR
FULL CLUTCH
HYDRAULIC-CLUTCH TRANSFORMATION KIT
LEVER
THROTTLE CONTROL
BRAKE CALIPER
RACING KIT
BUTTON PANEL
LEVER GUARD
CLIP-ON
STREET RACING REARSET
FUEL CAPS
STEERING NUT
CRASH PADS
PADDOCK STAND
MIRROR COVERS
REAR-VIEW MIRRORS
FOG LIGHTS KIT
HANDLEBARS ACCESSORIES
HANDLEBARS

Applicazioni cavi / Cables application list

Marca Brand	Cc	Modello Model	Anno dal From	Anno al To	Codice Reference	Novità New
APRILIA	1000	RSV4 FACTORY 1000	2009	2016	AP010	
APRILIA	1000	RSV4 R 1000	2009	2016	AP010	
APRILIA	1000	RSV4 APCR	2012	2016	AP012	
APRILIA	1000	TUONO 1000 R-FACTORY	2006	2009	AP006	
APRILIA	1000	RSV 1000 FACTORY DREAM	2004	2008	AP002	
DUCATI	748	749S / 749R / 749 DARK	2003	2006	DU001	
DUCATI	998	999 / 999S / 999R	2003	2006	DU001	
DUCATI	850	848 EVO	2011	2013	DU006	
DUCATI	850	848	2008	2010	DU006	
DUCATI	1100	1098R	2008	2009	DU006	
DUCATI	1200	1198R	2010	2010	DU006	
DUCATI	1200	1198	2009	2011	DU006	
DUCATI	1200	1198S	2009	2010	DU006	
HONDA	600	CBR 600	2007	2014	HN008	
HONDA	1000	CBR 1000	2004	2012	HN001	
HONDA	1000	CBR 1000	2013	2019	HN009	N
KAWASAKI	250	NINJA 250	2008	2010	ZX010	
KAWASAKI	400	NINJA 400	2018	2022	ZX013	N
KAWASAKI	600	ZX-6R	2005	2016	ZX004	
KAWASAKI	636	ZX-6R	2013	2022	ZX014	N
KAWASAKI	1000	ZX-10R	2008	2009	ZX001	
KAWASAKI	1000	ZX-10R	2011	2015	ZX011	
KAWASAKI	1000	ZX-10R	2016	2020	ZX012	N
SUZUKI	600	GSX-R 600	2006	2010	SU007	
SUZUKI	750	GSX-R 750	2006	2010	SU007	
SUZUKI	1000	GSX-R 1000	2017	2021	SU008	N
SUZUKI	1000	GSX-R 1000	2009	2016	SU004	
SUZUKI	1000	GSX-R 1000	2007	2008	SU001	
TRIUMPH	675	DAYTONA 675	2013	2014	TR005	
TRIUMPH	675	DAYTONA 675	2007	2009	TR001	
TRIUMPH	1200	THRUXTON	2010	2010	TR004	
YAMAHA	320	YZF-R3	2015	2020	YA015	N
YAMAHA	600	YZF-R6	2017	2022	YA014	N
YAMAHA	600	YZF-R6	2008	2016	YA003	
YAMAHA	600	YZF-R6	2006	2007	YA001	
YAMAHA	1000	YZF-R1	2015	2019	YA013	N
YAMAHA	1000	YZF-R1	2009	2014	YA011	
YAMAHA	1000	YZF-R1	2007	2008	YA009	
YAMAHA	1000	YZF-R1	2004	2006	YA006	

BRAKE/CLUTCH
MASTER CYLINDERS
ACCESSORIES
SPARE PARTS
CNC-WORKED FLUID
RESERVOIR
FULL CLUTCH
HYDRAULIC-CLUTCH
TRANFORMATION KIT
LEVER
THROTTLE CONTROL
BRAKE CALIPER
RACING KIT
BUTTON PANEL
LEVER GUARD
CLIP-ON
STREET RACING
REARSET
FUEL CAPS
STEERING NUT
CRASH PADS
PADDOCK STAND
MIRROR COVERS
REAR-VIEW MIRRORS
FOG LIGHTS KIT
HANDLEBARS
ACCESSORIES
HANDLEBARS

COMANDO GAS RAPIDO MONOCAVO

QUICK SINGLE CABLE THROTTLE CONTROL



BRAKE/CLUTCH
MASTER CYLINDERS

ACCESSORIES
SPARE PARTS

CNC-WORKED FLUID
RESERVOIR

FULL CLUTCH

HYDRAULIC-CLUTCH
TRANSFORMATION KIT

LEVER

THROTTLE CONTROL

BRAKE CALIPER

RACING KIT

BUTTON PANEL

LEVER GUARD

CLIP-ON

STREET RACING
REARSET

FUEL CAPS

STEERING NUT

CRASH PADS

PADDOCK STAND

MIRROR COVERS

REAR-VIEW MIRRORS

FOG LIGHTS KIT

HANDLEBARS
ACCESSORIES

HANDLEBARS

Codice Reference	Descrizione Description
MY011	Comando gas monocavo, completo di cavi universali e manopole GR001 <i>Single cable throttle control, provided with universal cables and GR001 grips</i>
MY012	Comando gas monocavo, completo di cavi universali e manopole GR002 <i>Single cable throttle control, provided with universal cables and GR002 grips</i>
MY013	Comando gas monocavo, senza cavi (no cavi originali: monta solo CU002) con manopole GR001 incluse <i>Single cable throttle control, without cables (fits CU002 only), with GR001 grips</i>
MY014	Comando gas monocavo, senza cavi (no cavi originali: monta solo CU002) con manopole GR002 incluse <i>Single cable throttle control, without cables (fits CU002 only), with GR002 grips</i>
MY015	Comando gas monocavo, senza cavi (no cavi originali: monta solo CU002) con manopole GR006 incluse <i>Single cable throttle control, without cables (fits CU002 only), with GR006 grips</i>
MY016	Comando gas monocavo, completo di cavi universali e manopole GR006 <i>Single cable throttle control, provided with universal cables and GR006 grips</i>

Colori / Colours

N ●
nero - black



Codice Reference	Descrizione Description
CU001	Trasmissioni gas universali per comando gas bicavo Accossato: MY001 - MY004, MY007 - MY008 <i>Universal cable kit for Accossato double-cable throttle control, references MY001 - MY004, MY007 - MY008</i>
CU002	Trasmissioni gas universali per comando gas monocavo Accossato: MY011 - MY016 <i>Universal cable kit for Accossato single-cable throttle control, references: MY011 - MY016</i>

Spiegazione Explanation

I kit cavi universali Accossato consentono di montare i nostri comandi gas su qualsiasi moto in commercio. Per l'installazione del prodotto, rivolgersi a un'officina specializzata.

Accossato universal-cable kits allow our throttle controls to be installed on any motorcycles. Installation by authorized workshop only.

BRAKE/CLUTCH
MASTER CYLINDERS
ACCESSORIES
SPARE PARTS
CNC-WORKED FLUID
RESERVOIR
FULL CLUTCH
HYDRAULIC-CLUTCH
TRANFORMATION KIT
LEVER
THROTTLE CONTROL
BRAKE CALIPER
RACING KIT
BUTTON PANEL
LEVER GUARD
CLIP-ON
STREET RACING
REARSET
FUEL CAPS
STEERING NUT
CRASH PADS
PADDOCK STAND
MIRROR COVERS
REAR-VIEW MIRRORS
FOG LIGHTS KIT
HANDLEBARS
ACCESSORIES
HANDLEBARS

COMANDI GAS THROTTLE CONTROL



TC005

Codice Reference	Descrizione Description	Caratteristiche tecniche Technical details
TC005	Comando gas velocità monocavo Single-cable throttle control	Corsa / Stroke (Corsa /Stroke 36 mm): Max 82° (Rotazione / rotation 66°) Manopole GR001N / GR001N racing grips: <i>Include / Included</i> Applicazioni / Suitable for: <i>Racing 125</i>

Colori / Colours

N ●
nero - black



TC006

Codice Reference	Descrizione Description	Caratteristiche tecniche Technical details
TC006	Comando gas monocavo Single-cable throttle control	Manopole GR001N / GR001N racing grips: <i>Include / Included</i> Applicazioni / Suitable for: <i>On-road bikes super bike</i>

Colori / Colours

N ●
nero - black

BRAKE/CLUTCH
MASTER CYLINDERS
ACCESSORIES
SPARE PARTS
CNC-WORKED FLUID
RESERVOIR
FULL CLUTCH
HYDRAULIC-CLUTCH
TRANFORMATION KIT
LEVER
THROTTLE CONTROL
BRAKE CALIPER
RACING KIT
BUTTON PANEL
LEVER GUARD
CLIP-ON
STREET RACING
REARSET
FUEL CAPS
STEERING NUT
CRASH PADS
Paddock STAND
MIRROR COVERS
REAR-VIEW MIRRORS
FOG LIGHTS KIT
HANDLEBARS
ACCESSORIES
HANDLEBARS



TC009 **NEW**

Codice Reference	Descrizione Description	Caratteristiche tecniche Technical details
TC009	Comando gas CNC Moto 3 bicavo per Honda CNC worked Moto 3 twin-cable throttle control for Honda	Corsa /Stroke: 23,6 mm Rotazione / rotation 60° Manopole GR006 incluse / GR006 racing grips included Usa cavi originali / Use original cables Fori filettati da / threaded holes: M7x1 e M6x1)

Colori manopole / Grips colours

O 
arancione
orange

Y 
giallo - yellow

B 
blu - blue

R 
rosso - red

G 
verde - green

- BRAKE/CLUTCH MASTER CYLINDERS
- ACCESSORIES SPARE PARTS
- CNC-WORKED FLUID RESERVOIR
- FULL CLUTCH
- HYDRAULIC-CLUTCH TRANSFORMATION KIT
- LEVER
- THROTTLE CONTROL
- BRAKE CALIPER
- RACING KIT
- BUTTON PANEL
- LEVER GUARD
- CLIP-ON
- STREET RACING REARSET
- FUEL CAPS
- STEERING NUT
- CRASH PADS
- Paddock STAND
- MIRROR COVERS
- REAR-VIEW MIRRORS
- FOG LIGHTS KIT
- HANDLEBARS ACCESSORIES
- HANDLEBARS

MANOPOLE RACING

RACING GRIPS



Codice Reference	Descrizione Description	Ø
GR001	Manopole racing* realizzate in mescola semi-rigida intercambiabili a tutte le moto stradali/ racing Racing grips made in semi-firm compound suitable for any street moto	22/24

Opzioni Options

Forate / Non forate
Pierced / Not pierced

Colori / Colours

N ●
nero - black

O ●
arancione
orange

Y ●
giallo - yellow

B ●
blu - blue

R ●
rosso - red

S ●
grigio - grey

G ●
verde - green

BRAKE/CLUTCH
MASTER CYLINDERS
 ACCESSORIES
SPARE PARTS
 CNC-WORKED FLUID
RESERVOIR
 FULL CLUTCH
 HYDRAULIC-CLUTCH
TRANSFORMATION KIT
 LEVER
 THROTTLE CONTROL
 BRAKE CALIPER
 RACING KIT
 BUTTON PANEL
 LEVER GUARD
 CLIP-ON
 STREET RACING
REARSET
 FUEL CAPS
 STEERING NUT
 CRASH PADS
 PADDOCK STAND
 MIRROR COVERS
 REAR-VIEW MIRRORS
 FOG LIGHTS KIT
 HANDLEBARS
ACCESSORIES
 HANDLEBARS



Codice Reference	Descrizione Description	Ø
GR002	Manopole racing intercambiabili a tutte le moto racing/stradali Racing grips suitable for any racing motorcycles	22/24

Opzioni Options	Colori / Colours
Forate / Non forate Pierced / Not pierced	<p>Manopole / Grips</p> <p>N ● nero - black</p> <p>Logo</p> <p>R ● rosso - red</p>

- BRAKE/CLUTCH MASTER CYLINDERS
- ACCESSORIES SPARE PARTS
- CNC-WORKED FLUID RESERVOIR
- FULL CLUTCH
- HYDRAULIC-CLUTCH TRANFORMATION KIT
- LEVER
- THROTTLE CONTROL
- BRAKE CALIPER
- RACING KIT
- BUTTON PANEL
- LEVER GUARD
- CLIP-ON
- STREET RACING REARSET
- FUEL CAPS
- STEERING NUT
- CRASH PADS
- PADOCK STAND
- MIRROR COVERS
- REAR-VIEW MIRRORS
- FOG LIGHTS KIT
- HANDLEBARS ACCESSORIES
- HANDLEBARS



Codice Reference	Descrizione Description	Ø
GR006	Manopole racing bicolore* realizzate in gomma termoplastica, miscela semi-rigida, intercambiabili a tutte le moto stradali/racing Two-tone racing grips made in semi-firm thermoplastic rubber compound, suitable for any street motorcycles	22/24
Opzioni Options	Colori / Colours	
Forate / Non forate Pierced / Not pierced	<p>O ● arancione orange</p> <p>Y ● giallo - yellow</p> <p>B ● blu - blue</p> <p>R ● rosso - red</p> <p>G ● verde - green</p>	

* Manopole vendute a coppie / Grips sold in pairs

- BRAKE/CLUTCH MASTER CYLINDERS
- ACCESSORIES SPARE PARTS
- CNC-WORKED FLUID RESERVOIR
- FULL CLUTCH
- HYDRAULIC-CLUTCH TRANFORMATION KIT
- LEVER
- THROTTLE CONTROL
- BRAKE CALIPER
- RACING KIT
- BUTTON PANEL
- LEVER GUARD
- CLIP-ON
- STREET RACING REARSET
- FUEL CAPS
- STEERING NUT
- CRASH PADS
- PADDOCK STAND
- MIRROR COVERS
- REAR-VIEW MIRRORS
- FOG LIGHTS KIT
- HANDLEBARS ACCESSORIES
- HANDLEBARS



Codice Reference	Descrizione Description	Ø
GR009	Manopole Racing con mescola morbida intercambiabili a tutte le moto racing/stradali Racing grips with soft compound suitable for any racing/street motorcycles	22/24

Opzioni
Options

Mescola media Medium soft compound	Mescola morbida Super soft compound
---------------------------------------	--

Colore / Colour

Manopole / Grips

N ●
nero - black

- BRAKE/CLUTCH MASTER CYLINDERS
- ACCESSORIES SPARE PARTS
- CNC-WORKED FLUID RESERVOIR
- FULL CLUTCH
- HYDRAULIC-CLUTCH TRANSFORMATION KIT
- LEVER
- THROTTLE CONTROL
- BRAKE CALIPER
- RACING KIT
- BUTTON PANEL
- LEVER GUARD
- CLIP-ON
- STREET RACING REARSET
- FUEL CAPS
- STEERING NUT
- CRASH PADS
- PADDOCK STAND
- MIRROR COVERS
- REAR-VIEW MIRRORS
- FOG LIGHTS KIT
- HANDLEBARS ACCESSORIES
- HANDLEBARS

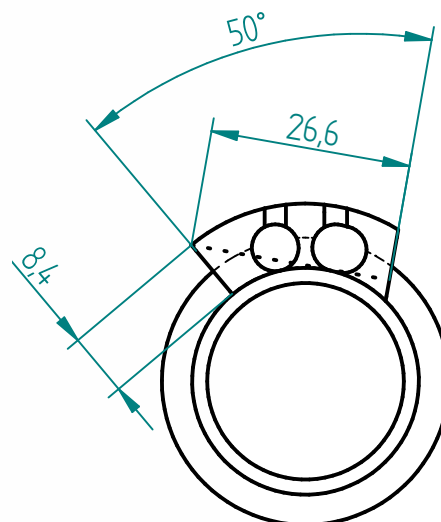

Misure dell'attacco manopola gas
Measures of the throttle control connection

Codice Reference	Descrizione Description	Note Note
GR010	Manopole Custom per manubri da 1 pollice (25,4mm) Custom grips for 1 inch (25,4mm) handlebar	Vendute a coppie Sold in pairs
Opzioni Options		Colore / Colour
Forate Pierced		Manopole / Grips N ● nero - black

Applicazioni / Application list

Marca Brand	CC	Modello Model	Anno dal From	Anno al To	Novità New
Triumph	900	Bonneville T100	2015	2019	N
Triumph	900	Bonneville T100 Range	2018	2018	N
Triumph	2294	Rocket III	2005	2010	N
Triumph	2294	Rocket III	2017	2018	N
Triumph	2294	Rocket III Roadster	2011	2016	N
Triumph	2294	Rocket III Touring	2008	2016	N
Triumph	1597	Thunderbird	2011	2016	N
Triumph	1597	Thunderbird 1600	2009	2010	N
Triumph	1699	Thunderbird Storm	2011	2016	N

Nota: queste manopole possono essere montate ed adattate su altre moto, con manubrio da 1 pollice (25,4mm) e l'attacco mostrato nello schema
Note: these grip can be fitted on other motorbikes, with 1-inch (25.4mm) handlebar and throttle control connection shown in the scheme

BRAKE/CLUTCH
MASTER CYLINDERS
 ACCESSORIES
SPARE PARTS
 CNC-WORKED FLUID
RESERVOIR
 FULL CLUTCH
 HYDRAULIC-CLUTCH
TRANSFORMATION KIT
 LEVER
 THROTTLE CONTROL
 BRAKE CALIPER
 RACING KIT
 BUTTON PANEL
 LEVER GUARD
 CLIP-ON
 STREET RACING
REARSET
 FUEL CAPS
 STEERING NUT
 CRASH PADS
 PADDOCK STAND
 MIRROR COVERS
 REAR-VIEW MIRRORS
 FOG LIGHTS KIT
 HANDLEBARS
ACCESSORIES
 HANDLEBARS

SGANCIO RAPIDO COMANDO GAS GAS CONTROL QUICK DISCONNECT



BRAKE/CLUTCH
MASTER CYLINDERS

ACCESSORIES
SPARE PARTS

CNC-WORKED FLUID
RESERVOIR

FULL CLUTCH

HYDRAULIC-CLUTCH
TRANSFORMATION KIT

LEVER

THROTTLE CONTROL

BRAKE CALIPER

RACING KIT

BUTTON PANEL

LEVER GUARD

CLIP-ON

STREET RACING
REARSET

FUEL CAPS

STEERING NUT

CRASH PADS

Paddock STAND

MIRROR COVERS

REAR-VIEW MIRRORS

FOG LIGHTS KIT

HANDLEBARS
ACCESSORIES

HANDLEBARS

Codice Reference	Descrizione Description
SR001	Sgancio rapido per comando gas Accossato Quick disconnecter for Accossato throttle control



Lunghezze L1 disponibili
Available L1 length

111 mm • 131 mm • 151 mm • 486 mm • Universali / Universal

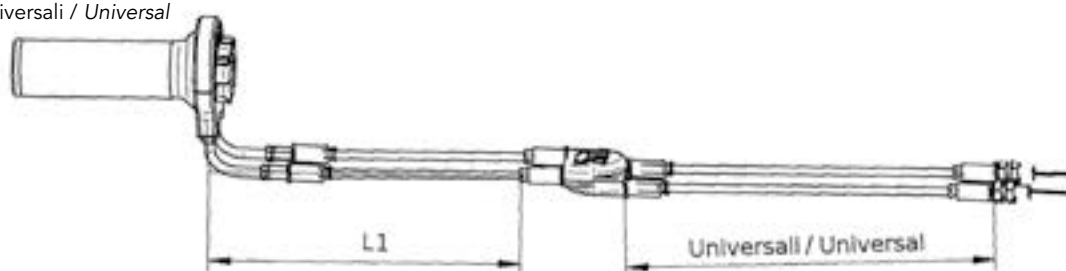

Vantaggi
Pros

- Riduce i tempi di sostituzione del comando gas
- Non richiede interventi sul motore
- Non necessita regolazione cavi
- Time reduction in throttle control replacement
- No need to act onto the engine
- No need for cable adjustment

Spiegazione
Explanation

Il dispositivo nasce pensando alle esigenze del mondo delle competizioni motociclistiche, in cui l'eventuale rottura del comando gas (ad esempio in seguito a caduta) comporta la perdita di un turno di prove a causa del lungo e delicato lavoro di sostituzione dei cavi. L'utente potrà montare e registrare il dispositivo, avendo cura di posizionare lo sdoppiatore in zona accessibile ma protetta dagli urti, procedendo al di fuori del clima caotico delle gare, con calma e perizia. Fornitosi di uno o più kit lato acceleratore di ricambio, in caso di necessità, potrà sostituirlo con un altro semplicemente svitando una vite e senza dover toccare alcun registro di tensionamento. Il lato motore viene fornito di cavi universali, mentre per il lato acceleratore è possibile scegliere la lunghezza dei cavi.

This device was created to fulfil at best the need for speed in 2-wheel competition world. In case of any brakages of throttle control (i.e. due to a fall), time-taking cable replacement would mean to miss a turn during testing. Assemble and adjust the device carefully, by putting the splitter into a position easy to reach, but sheltered from impacts. By necessity, quick disconnecter allows you to replace throttle control by simply unscrewing the specific screw. No need to act on tentioning adjuster. Engine side is provided with universal cables, whilst for gas control side cables are available in several lengths

Accessori / Accessory

Ricambio kit cavi sgancio rapido / Quick disconnecter cable spare parts

Codice Reference	Descrizione Description	Codice Reference	Descrizione Description
RC045-111	Ricambio kit cavi sgancio rapido comando gas lunghezza: 111 mm Quick disconnecter cable spare parts "throttle control side" length 111mm	RC045-486	Ricambio kit cavi sgancio rapido comando gas lunghezza 486 mm Quick disconnecter cable spare parts "throttle control side" length 486mm
RC045-131	Ricambio kit cavi sgancio rapido comando gas lunghezza: 131mm / Quick disconnecter cable spare parts "throttle control side" length 131mm	RC060	Ricambio kit cavi sgancio rapido lato motore / Quick disconnecter cable spare parts "engine side"
RC045-151	Ricambio kit cavi sgancio rapido comando gas lunghezza 151 mm Quick disconnecter cable spare parts "throttle control side" length 151mm		

BRAKE/CLUTCH
MASTER CYLINDERS
 ACCESSORIES
SPARE PARTS
 CNC-WORKED FLUID
RESERVOIR
 FULL CLUTCH
 HYDRAULIC-CLUTCH
TRANFORMATION KIT
 LEVER
 THROTTLE CONTROL
 BRAKE CALIPER
 RACING KIT
 BUTTON PANEL
 LEVER GUARD
 CLIP-ON
 STREET RACING
REARSET
 FUEL CAPS
 STEERING NUT
 CRASH PADS
 PADDOCK STAND
 MIRROR COVERS
 REAR-VIEW MIRRORS
 FOG LIGHTS KIT
 HANDLEBARS
ACCESSORIES
 HANDLEBARS

SENSORI DEL CAMBIO IN COMPRESSIONE

QUICK SHIFTER SENSOR IN COMPRESSION



Codice Reference	Descrizione Description	Caratteristiche tecniche Technical details
QS001	Sensore del cambio in compressione Quick shifter in compression	<p>Materiale: Alluminio AL 7075 / Material: AL 7075 Aluminium</p> <p>Foro astina: M6 destrorso/sinistrorso / Holder pitch: M6 righthanded/lefthanded</p> <p>Dimensioni: 43 x 26 x 10 / Dimensions: 43 x 26 x 10</p> <p>Peso: 30 gr / Weight: 30 gr</p> <p>Range carico: min 4 kg max 25 kg / Load range min 4 kg max 25 kg</p> <p>Lunghezza cavo: 25 cm / Cable length 25 cm</p> <p>Connettore: 2 vie femmina (mini universal Mate-N-lock) / Connector: 2-port female manifold</p> <p>Segnale di uscita: NA (normalmente aperto) / Output signal: NO (normally open)</p>

Note: Centraline consigliate • Dynojet e Power Commander con predisposizione per sensore cambio
 Note: Dynojet and Power Commander, equipped with quick shifter setup

Accessori / Accessory

Codice Reference	Descrizione Description	Caratteristiche tecniche Technical details
CAV08	Prolunga cavo / Extension cable	<p>Lunghezza cavo: 80 cm / Cable length: 80 cm</p> <p>Connettore: 2 vie maschio / Connector: 2-port male manifold (mini universal Mate-N-lock)</p>
VM001	Kit 1 x vite + 1 x molla per sensore in compressione / Kit composed of 1 x screw + 1 x spring for quick shifter in compression	

- BRAKE/CLUTCH MASTER CYLINDERS
- ACCESSORIES SPARE PARTS
- CNC-WORKED FLUID RESERVOIR
- FULL CLUTCH
- HYDRAULIC-CLUTCH TRANSFORMATION KIT
- LEVER
- THROTTLE CONTROL
- BRAKE CALIPER
- RACING KIT
- BUTTON PANEL
- LEVER GUARD
- CLIP-ON
- STREET RACING REARSET
- FUEL CAPS
- STEERING NUT
- CRASH PADS
- PADDOCK STAND
- MIRROR COVERS
- REAR-VIEW MIRRORS
- FOG LIGHTS KIT
- HANDLEBARS ACCESSORIES
- HANDLEBARS

SENSORI DEL CAMBIO IN TRAZIONE

QUICK SHIFTER SENSOR IN TRACTION



Codice Reference	Descrizione Description	Caratteristiche tecniche Technical details
QS002	Sensore del cambio in trazione Quick shifter in traction	<p>Materiale: Alluminio AL 7075 / Material: AL 7075 Aluminium</p> <p>Foro astina: M6 destrorso/sinistrorso / Holder pitch: M6 righthanded/left-handed</p> <p>Dimensioni: 44,5 x 22 x 10 / Dimensions: 44,5 x 22 x 10</p> <p>Peso: 25 gr / Weight: 25 gr</p> <p>Range carico: min 3 kg max 30 kg / Load range min 3 kg max 30 kg</p> <p>Lunghezza cavo: 25 cm / Cable length 25 cm</p> <p>Connettore: 2 vie femmina (mini universal Mate-N-lock) / Connector: 2-port female manifold</p> <p>Segnale di uscita: NA (normalmente aperto) / Output signal: NO (normally open)</p>

Note: Centraline consigliate • Dynojet e Power Commander con predisposizione per sensore cambio
 Note: Dynojet and Power Commander, equipped with quick shifter setup

Accessori / Accessory

Codice Reference	Descrizione Description	Caratteristiche tecniche Technical details
CAV08	Prolunga cavo / Extension cable	<p>Lunghezza cavo: 80 cm / Cable length: 80 cm</p> <p>Connettore: 2 vie maschio / Connector: 2-port male manifold (mini universal Mate-N-lock)</p>
VM002	Kit 1 x vite + 1 x molla per sensore in trazione / Kit composed of 1 x screw + 1 x spring for quick shifter in traction	

- BRAKE/CLUTCH MASTER CYLINDERS
- ACCESSORIES SPARE PARTS
- CNC-WORKED FLUID RESERVOIR
- FULL CLUTCH
- HYDRAULIC-CLUTCH TRANSFORMATION KIT
- LEVER
- THROTTLE CONTROL
- BRAKE CALIPER
- RACING KIT
- BUTTON PANEL
- LEVER GUARD
- CLIP-ON
- STREET RACING REARSET
- FUEL CAPS
- STEERING NUT
- CRASH PADS
- Paddock STAND
- MIRROR COVERS
- REAR-VIEW MIRRORS
- FOG LIGHTS KIT
- HANDLEBARS ACCESSORIES
- HANDLEBARS

PINZE FRENO INTERASSE 108

BRAKE CALIPER DISTANCE 108



■ Pinza freno CNC monoblocco / Monoblock CNC-worked brake caliper

Codice Reference	Caratteristiche tecniche Technical details
PZ001	Interasse / Distance: 108 mm
	Off-set: 22,5 mm
	Pistoncini titanio autoventilati D34mm (n°4) / Small pistons titanium-made, self-ventilated, D34mm (4pcs)
	Guarnizione Parapolvere / Dust seal: NO
	Colore / Color: Cromato / Chrome - Ossidata nera / Black oxidation - Ossido duro / Hard oxidation
	Pastiglie non incluse / Brake pads not included
	N° pastiglie x pinza 4 pz / N° of brake pads per caliper 4pcs
Pinza singola (dx oppure sx) / Single brake caliper (L or R)	

■ Accessori di ricambio (venduti singolarmente) / Spare parts (sold individually)

Codice Reference	Descrizione Description
AGPA134ZXC	Pastiglie freno mescola racing ZXC (4 pz x blister) / Brake pad ZXC racing compound (4pcs x blister) *
AGPA134EV2	Pastiglie freno mescola racing EV2 (2 pz x blister) / Brake pad EV2 racing compound (2pcs x blister) **
PT034	Pistone autoventilato in titanio, Ø34 / Self-ventilated piston, made in aluminium, Ø34
UP034	Guarnizione pistone Ø34 / Ø34 piston seal
AGPET	Perno in titanio / Titanium pin
AGM01	Molla anti-vibrazioni / Anti-rattle spring
AGFS	Fermo di sicurezza / Safety catch
RC012	Valvola di spurgo M8x1 / Bleeding valve M8x1

Note / Note:

* ZXC: mescola in carbon-ceramica, necessitano pre-riscaldamento / Carbon-pottery compound, warm-up needed

** EV2: Top racing, necessitano pre-riscaldamento, sconsigliate per dischi "Wave" e "Butterfly" / Top racing, warm-up needed, not recommended for "wave" and "butterfly" brake rotor

BRAKE/CLUTCH
MASTER CYLINDERS
ACCESSORIES
SPARE PARTS
CNC-WORKED FLUID
RESERVOIR
FULL CLUTCH
HYDRAULIC-CLUTCH
TRANSFORMATION KIT
LEVER
THROTTLE CONTROL
BRAKE CALIPER
RACING KIT
BUTTON PANEL
LEVER GUARD
CLIP-ON
STREET RACING
REARSET
FUEL CAPS
STEERING NUT
CRASH PADS
PADDOCK STAND
MIRROR COVERS
REAR-VIEW MIRRORS
FOG LIGHTS KIT
HANDLEBARS
ACCESSORIES
HANDLEBARS



Codice Reference	Descrizione Description	Caratteristiche tecniche Technical details
PZ010	Pinza freno CNC monoblocco Monoblock CNC-worked brake caliper	<p>Interasse - Distance: 108mm</p> <p>Off-Set: 22,5mm</p> <p>Pistoncini - Small pistons: Titanio autoventilati Ø34mm (n°2) + Ø38mm (n°2) / titanium-made, Self-ventilated, Ø34mm (n°2) + Ø38mm (n°2);</p> <p>Colore / Color: Cromato / Chrome - Ossidata nera / Black oxidation - Ossido duro / Hard oxidation</p> <p>Pastiglie - brake pads: N° 2 pastiglie x pinza - N° 2 of brake pads per caliper: AGPA 106 ZXC</p> <p>Contenuto confezione - pack contents: Pinza singola (Dx oppure SX); single brake caliper (L or R)</p>

■ Accessori di ricambio (venduti singolarmente) / Spare parts (sold individually)

Codice Reference	Descrizione Description
AGPA106ZXC	Pastiglie freno mescola racing ZXC (2 pz x blister) / Brake pad ZXC racing compound (2pcs x blister)*
PT034	Pistone autoventilato in titanio, Ø38 / Self-ventilated piston, made in aluminium, Ø38
UP034	Pistone autoventilato in titanio, Ø34 / Self-ventilated piston, made in aluminium, Ø34
AGM05	Molla anti-vibrazioni / Anti-rattle spring
RC012	Valvola di spurgo M8x1 / Bleeding valve M8x1
UP034	Guarnizione pistone Ø34 / Ø34 piston seal
UP038	Guarnizione pistone Ø38 / Ø38 piston seal

Note / Note:

* ZXC: mescola in carbon-ceramica, necessitano pre-riscaldamento / Carbon-pottery compound, warm-up needed

- BRAKE/CLUTCH MASTER CYLINDERS
- ACCESSORIES SPARE PARTS
- CNC-WORKED FLUID RESERVOIR
- FULL CLUTCH
- HYDRAULIC-CLUTCH TRANSFORMATION KIT
- LEVER
- THROTTLE CONTROL
- BRAKE CALIPER
- RACING KIT
- BUTTON PANEL
- LEVER GUARD
- CLIP-ON
- STREET RACING REARSET
- FUEL CAPS
- STEERING NUT
- CRASH PADS
- Paddock STAND
- MIRROR COVERS
- REAR-VIEW MIRRORS
- FOG LIGHTS KIT
- HANDLEBARS ACCESSORIES
- HANDLEBARS



Codice Reference	Descrizione Description	Caratteristiche tecniche Technical details
PZ012	Pinza freno CNC radiale CNC-worked radial brake caliper	Interasse - Distance: 108mm
		Off-Set: 22,5mm
		Pistoncini - Small pistons: Alluminio ergal Ø29,5mm (n°2) + Ø34mm (n°2) / Ergal aluminium made Ø29,5mm (n°2) + Ø34mm (n°2)
		Guarnizione parapolvere - Dual seal: si / yes
		Colore / Color: Cromato / Chrome - Ossidata nera / Black oxidation - Ossido duro / Hard oxidation
		Pastiglie - brake pads: N° 2 pastiglie x pinza - N° 2 of brake pads per caliper: AGPA96 OR / ST / ZXC
		Contenuto confezione - pack contents: Pinza singola (Dx oppure SX); single brake caliper (L or R)

■ Accessori di ricambio (venduti singolarmente) / Spare parts (sold individually)

Codice Reference	Descrizione Description
AGPA96OR	Pastiglie freno miscela organica (2 pz x blister) / Brake pad with organic compound (2pcs x blister)
AGPA96ST	Pastiglie freno miscela stradale (2 pz x blister) / Brake pad with road use compound (2pcs x blister)
AGPA96ZXC	Pastiglie freno miscela racing (2 pz x blister) / Brake pad with racing compound (2pcs x blister)
PA034	Pistone in alluminio, Ø34 / piston made in aluminium, Ø34
PA295	Pistone in alluminio, Ø29,5 / piston made in aluminium, Ø29,5
GP034	Guarnizione parapolvere Ø34 / Ø34 dust seal
GP295	Guarnizione parapolvere Ø29,5 / Ø29,5 dust seal
AGPEI	Perno in alluminio / Aluminium pin
AGM01	Molla anti-vibrazioni / Anti-rattle spring
AGFS	Fermo di sicurezza / Safety catch
RC012	Valvola di spurgo M8X1 / Bleeding valve M8X1
UP034	Guarnizione pistone Ø34 / Ø34 piston seal
UP295	Guarnizione pistone Ø29,5 / Ø29,5 piston seal

- BRAKE/CLUTCH MASTER CYLINDERS
- ACCESSORIES SPARE PARTS
- CNC-WORKED FLUID RESERVOIR
- FULL CLUTCH
- HYDRAULIC-CLUTCH TRANSFORMATION KIT
- LEVER
- THROTTLE CONTROL
- BRAKE CALIPER
- RACING KIT
- BUTTON PANEL
- LEVER GUARD
- CLIP-ON
- STREET RACING REARSET
- FUEL CAPS
- STEERING NUT
- CRASH PADS
- PADDOCK STAND
- MIRROR COVERS
- REAR-VIEW MIRRORS
- FOG LIGHTS KIT
- HANDLEBARS ACCESSORIES
- HANDLEBARS



■ Pinza freno forgiata monoblocco / Monoblock forged brake caliper

Codice Reference	Caratteristiche tecniche Technical details
PZ002	Interasse / Distance: 108 mm
	Off-set: 22,5 mm
	Pistoncini titanio autoventilati D34mm (n°4) / Small pistons titanium-made, self-ventilated, D34mm (4pcs)
	Guarnizione Parapolvere / Dust seal: NO
	Colore ossidazione nera / Black oxidation
	Pastiglie non incluse / Brake pads not included
	N° pastiglie x pinza 4 pz / N° of brake pads per caliper 4pcs
	Contenuto confezione pinza singola (dx oppure sx) / Pack contents single brake caliper (L or R)

■ Accessori di ricambio (venduti singolarmente) / Spare parts (sold individually)

Codice Reference	Descrizione Description
AGPA134ZXC	Pastiglie freno mescola racing (4 pz x blister) / Brake pad with racing compound (4pcs x blister)
AGPA134EV2	Pastiglie freno mescola racing (2 pz x blister) / Brake pad with racing compound (2pcs x blister)
PT034	Pistone autoventilato in titanio, Ø34 / Self-ventilated piston, made in aluminium, Ø34
UP034	Guarnizione pistone Ø34 / Ø34 piston seal
AGPET	Perno in titanio / Titanium pin
AGPEI	Perno inox / stainless steel pin
AGM01	Molla anti-vibrazioni / Anti-rattle spring
AGFS	Fermo di sicurezza / Safety catch
RC012	Valvola di spurgo m8x1 / Bleeding valve M8x1

Colori pinze anodizzate / Anodized calipers colours

N ●
nero - black

BRAKE/CLUTCH
MASTER CYLINDERS
 ACCESSORIES
SPARE PARTS
 CNC-WORKED FLUID
RESERVOIR
 FULL CLUTCH
 HYDRAULIC-CLUTCH
TRANFORMATION KIT
 LEVER
 THROTTLE CONTROL
 BRAKE CALIPER
 RACING KIT
 BUTTON PANEL
 LEVER GUARD
 CLIP-ON
 STREET RACING
REARSET
 FUEL CAPS
 STEERING NUT
 CRASH PADS
 PADDOCK STAND
 MIRROR COVERS
 REAR-VIEW MIRRORS
 FOG LIGHTS KIT
 HANDLEBARS
ACCESSORIES
 HANDLEBARS



Colori pinze anodizzate / Anodized calipers colours

A ●	N ●	R ●	Y ●	B ●
antracite - charcoal	nero - black	rosso - red	oro - gold	blu - blue

Colori pinze verniciate / Painted calipers colours

VN ●	VR ●	VY ●	VB ●	VRF ●	VS ●	VG ●
nero - black	rosso - red	giallo fluo fluor yellow	blu - blue	rosso fluo - Fluor red	argento - silver	verde - green

VYB ●	VW ○	VP ●
giallo yellow	bianco - white	Verde acqua Green water

■ Pinza freno forgiata monoblocco / Monoblock forged brake caliper

Codice Reference	Caratteristiche tecniche Technical details
PZ004	Interasse / Distance: 108 mm
	Off-set: 22,5 mm
	Pistoncini alluminio Ergal D34mm (n°4) / Small pistons ergal aluminium D34mm (4pcs)
	Guarnizione parapolvere / Dust seal: Si / Yes
	Materiale: alluminio / Raw material: aluminium
	Pastiglie incluse / Brake pads included
Contenuto confezione pinza dx + pinza sx / Pack contents L+R brake calipers	

■ Accessori di ricambio (venduti singolarmente) / Spare parts (sold individually)

Codice Reference	Descrizione Description
AGPA134ZXC	Pastiglie freno mescola racing (4 pz x blister) / Brake pad with racing compound (4 pcs x blister)
AGPA134EV2	Pastiglie freno mescola racing (2 pz x blister) / Brake pad with racing compound (2 pcs x blister)
PA034	Pistone in alluminio, Ø 34 / Ø 34 aluminium pin
UP034	Guarnizione pistone Ø 34 / Ø 34 piston seal
GP034	Guarnizione parapolvere Ø 34 / Ø 34 dust seal
AGPEI	Perno Inox / Stainless steel pin
AGM01	Molla anti-vibrazioni / Anti-rattle spring
AGFS	Fermo di sicurezza / Safety catch
RC012	Valvola di spurgo M8x1 / Bleeding valve M8x1

BRAKE/CLUTCH
 MASTER CYLINDERS
 ACCESSORIES
 SPARE PARTS
 CNC-WORKED FLUID
 RESERVOIR
 FULL CLUTCH
 HYDRAULIC-CLUTCH
 TRANSFORMATION KIT
 LEVER
 THROTTLE CONTROL
 BRAKE CALIPER
 RACING KIT
 BUTTON PANEL
 LEVER GUARD
 CLIP-ON
 STREET RACING
 REARSET
 FUEL CAPS
 STEERING NUT
 CRASH PADS
 PADDOCK STAND
 MIRROR COVERS
 REAR-VIEW MIRRORS
 FOG LIGHTS KIT
 HANDLEBARS
 ACCESSORIES
 HANDLEBARS

PINZE FRENO INTERASSE 100

BRAKE CALIPER DISTANCE 100



■ Pinza freno CNC monoblocco / Monoblock CNC-worked brake caliper

Codice Reference	Caratteristiche tecniche Technical details
PZ005	Interasse / Distance: 100 mm
	Off-set: 30 mm
	Pistoncini titanio autoventilati, n°2 D34mm + n°2 D38mm / Small pistons titanium-made, self ventilated, D34mm (2pcs) + D38mm (2pcs)
	Guarnizione Parapolvere / Dust seal: No
	Colore / Color: Cromato / Chrome - Ossidata nera / Black oxidation - Ossido duro / Hard oxidation
	Pastiglie non incluse / Brake pads not included
	N° pastiglie x pinza 2 pz / N° of brake pads per caliper 2 pcs
Pinza singola (dx oppure sx) / Single brake calipers (L or R)	

■ Accessori di ricambio (venduti singolarmente) / Spare parts (sold individually)

Codice Reference	Descrizione Description
AGPA137ZXC	Pastiglie freno mescola racing ZXC (2 pz x blister) / Brake pad ZXC with racing compound (2pcs x blister)
PT034	Pistone autoventilato in titanio, Ø34 / Self-ventilated piston, made in aluminium, Ø34
UP034	Guarnizione pistone Ø34 / Ø34 piston seal
PT038	Pistone autoventilato in titanio, Ø38 / Self-ventilated piston, made in aluminium, Ø38
UP038	Guarnizione pistone Ø38 / Ø38 piston seal
AGM02	Molla anti vibrazioni / Anti-rattle spring
RC012	Valvola di spurgo M8x1 / bleeding valve M8x1

Note: ZXC - Mescola in carbon-ceramica, necessitano pre-riscaldamento
Note: ZXC - Carbon-pottery compound, warm-up needed

BRAKE/CLUTCH
MASTER CYLINDERS
 ACCESSORIES
SPARE PARTS
 CNC-WORKED FLUID
RESERVOIR
 FULL CLUTCH
 HYDRAULIC-CLUTCH
TRANSFORMATION KIT
 LEVER
 THROTTLE CONTROL
 BRAKE CALIPER
 RACING KIT
 BUTTON PANEL
 LEVER GUARD
 CLIP-ON
 STREET RACING
REARSET
 FUEL CAPS
 STEERING NUT
 CRASH PADS
 PADDOCK STAND
 MIRROR COVERS
 REAR-VIEW MIRRORS
 FOG LIGHTS KIT
 HANDLEBARS
ACCESSORIES
 HANDLEBARS



■ Pinza freno CNC radiale / CNC-worked radial caliper

Codice Reference	Caratteristiche tecniche Technical details
PZ011	Interasse - Distance: 100 mm
	Off-set: 30 mm
	Pistoncini - Small pistons: alluminio ergal Ø29,5 mm (n°2) + Ø 34 (n°2) / Ergal aluminium made, Ø29,5 mm (n°2) + Ø 34 (n°2)
	Guarnizione parapolvere - Dust seal: si / yes
	Colore / Color: Cromato / Chrome - Ossidata nera / Black oxidation - Ossido duro / Hard oxidation
	Pastiglie - Brake pads: n° 2 pastiglie x pinza - n° 2 of brake pads per caliper: AGPA 96 OR / ST / ZXC
	Contenuto confezione - Pack contents: pinza singola (dx oppure sx); single brake caliper (l or r)

■ Accessori di ricambio (venduti singolarmente) / Spare parts (sold individually)

Codice Reference	Descrizione Description
AGPA96OR	Pastiglie freno mescola organica (2 pz x blister) / Brake pad with organic compound (2pcs x blister)
AGPA96ST	Pastiglie freno mescola stradale (2 pz x blister) / Brake pad with road use compound (2pcs x blister)
AGPA96ZXC	Pastiglie freno mescola racing (2 pz x blister) / Brake pad with racing compound (2pcs x blister)
PA034	Pistone in alluminio, Ø34 / piston made in aluminium, Ø34
PA295	Pistone in alluminio, Ø29,5 / piston made in aluminium, Ø29,5
GP034	Guarnizione parapolvere Ø34 / Ø34 dust seal
GP295	Guarnizione parapolvere Ø29,5 / Ø29,5 dust seal
AGPEI	Perno in alluminio / Aluminium pin
AGM01	Molla anti-vibrazioni / Anti-rattle spring
AGFS	Fermo di sicurezza / Safety catch
RC012	Valvola di spurgo M8X1 / Bleeding valve M8X1
UP034	Guarnizione pistone Ø34 / Ø34 piston seal
UP295	Guarnizione pistone Ø29,5 / Ø29,5 piston seal

- BRAKE/CLUTCH MASTER CYLINDERS
- ACCESSORIES SPARE PARTS
- CNC-WORKED FLUID RESERVOIR
- FULL CLUTCH
- HYDRAULIC-CLUTCH TRANFORMATION KIT
- LEVER
- THROTTLE CONTROL
- BRAKE CALIPER
- RACING KIT
- BUTTON PANEL
- LEVER GUARD
- CLIP-ON
- STREET RACING REARSET
- FUEL CAPS
- STEERING NUT
- CRASH PADS
- PADDOCK STAND
- MIRROR COVERS
- REAR-VIEW MIRRORS
- FOG LIGHTS KIT
- HANDLEBARS ACCESSORIES
- HANDLEBARS



■ Pinza freno forgiata monoblocco / Monoblock forged brake caliper

Codice Reference	Caratteristiche tecniche Technical details
PZ007	Interasse / Distance: 100 mm
	Off-set: 30 mm
	Pistoncini alluminio ergal D34mm (n°2) + (n°2) D38mm / Small pistons ergal aluminium D34mm (2pcs) + (2pcs) D38mm
	Guarnizione Parapolvere / Dust seal: Si / Yes
	Pastiglie incluse / Brake pads included
	N° pastiglie x pinza 2 pz / N° of brake pads per caliper 2 pcs
Contenuto confezione pinza singola (dx oppure sx) / Pack contents single brake calipers (L or R)	

■ Accessori di ricambio (venduti singolarmente) / Spare parts (sold individually)

Codice Reference	Descrizione Description
AGPA137ZXC	Pastiglie freno mescola racing ZXC (2 pz x blister) / Brake pad ZXC with racing compound (2pcs x blister)
PA034	Pistone in alluminio, Ø34 / Ø34 aluminium pin
PA038	Pistone in alluminio, Ø38 / Ø38 aluminium pin
RC012	Valvola di spurgo m8x1 / bleeding valve M8x1
UP034	Guarnizione pistone Ø34 / Ø34 piston seal
UP038	Guarnizione pistone Ø38 / Ø38 piston seal
AGM02	Molla anti vibrazioni / anti-rattle spring
GP034	Guarnizione parapolvere Ø34 / Ø34 dust seal
GP038	Guarnizione parapolvere Ø38 / Ø38 dust seal

Colori pinze anodizzate / Anodized calipers colours

A ● antracite - charcoal
N ● nero - black

Colori pinze verniciate / Painted calipers colours

VN ● nero - black
VR ● rosso - red
VY ● giallo fluo / fluor yellow
VB ● blu - blue
VRF ● rosso fluo - Fluor red
VS ● argento - silver
VG ● verde - green

VYB ● giallo yellow
VW ○ bianco - white
VP ● Verde acqua / Green water

Note: ZXC - Mescola in carbon-ceramica, necessitano pre-riscaldamento
Note: ZXC - Carbon-pottery compound, warm-up needed

BRAKE/CLUTCH
MASTER CYLINDERS
ACCESSORIES
SPARE PARTS
CNC-WORKED FLUID
RESERVOIR
FULL CLUTCH
HYDRAULIC-CLUTCH
TRANFORMATION KIT
LEVER
THROTTLE CONTROL
BRAKE CALIPER
RACING KIT
BUTTON PANEL
LEVER GUARD
CLIP-ON
STREET RACING
REARSET
FUEL CAPS
STEERING NUT
CRASH PADS
PADDOCK STAND
MIRROR COVERS
REAR-VIEW MIRRORS
FOG LIGHTS KIT
HANDLEBARS
ACCESSORIES
HANDLEBARS

PINZE RADIALI MOTO 3 CNC

MOTO 3 CNC-WORKED BRAKE CALIPERS



■ Pinza freno CNC monoblocco / Monoblock CNC-worked brake caliper

Codice Reference	Caratteristiche tecniche Technical details
PZ006	Interasse / Distance: 60 mm
	Off-set: 20,5 mm
	Pistoncini titanio autoventilati, n°2 D34mm / Small pistons titanium-made, self-ventilated, D34mm (2pcs)
	Guarnizione Parapolvere / Dust seal: No
	Colore ossido duro / Colour hard oxidation
	Pastiglie non incluse / Brake pads not included
	N° pastiglie x pinza 2 pz / N° of brake pads per caliper 2 pcs
Contenuto confezione pinza singola (dx oppure sx) / Pack contents single brake calipers (L or R)	

■ Accessori di ricambio (venduti singolarmente) / Spare parts (sold individually)

Codice Reference	Descrizione Description
AGPA134ZXC	Pastiglie freno miscela racing ZXC (4 pz x blister) / brake pad ZXC with racing compound (4pcs x blister)
PT034	Pistone autoventilato in titanio, Ø34 / self-ventilated piston, made in aluminium, Ø34
UP034	Guarnizione pistone Ø34 / Ø34 piston seal
AGPET	Perno in titanio / titanium pin
AGM01	Molla anti-vibrazioni / anti-rattle spring
AGFS	Fermo di sicurezza / safety catch
RC012	Valvola di spurgo M8x1 / bleeding valve M8x1

Note: ZXC - Miscela in carbon-ceramica, necessitano pre-riscaldamento
 Note: ZXC - Carbon-pottery compound, warm-up needed

- BRAKE/CLUTCH MASTER CYLINDERS
- ACCESSORIES SPARE PARTS
- CNC-WORKED FLUID RESERVOIR
- FULL CLUTCH
- HYDRAULIC-CLUTCH TRANSFORMATION KIT
- LEVER
- THROTTLE CONTROL
- BRAKE CALIPER
- RACING KIT
- BUTTON PANEL
- LEVER GUARD
- CLIP-ON
- STREET RACING REARSET
- FUEL CAPS
- STEERING NUT
- CRASH PADS
- PADOCK STAND
- MIRROR COVERS
- REAR-VIEW MIRRORS
- FOG LIGHTS KIT
- HANDLEBARS ACCESSORIES
- HANDLEBARS

PINZA POSTERIORE AD ATTACCO RADIALE REAR BRAKE CALIPER WITH RADIAL MOUNT



■ Pinza freno CNC monoblocco / Monoblock CNC-worked brake caliper

Codice Reference	Caratteristiche tecniche Technical details
PZ008	Interasse / Distance: 60 mm
	Off-set: 20,5 mm
	Pistoncini titanio autoventilati D29,5mm (n°2) / Small pistons titanium-made, self-ventilated, D29,5mm (2 pcs)
	Guarnizione Parapolvere / Dust seal: No
	Colore ossido duro / Colour hard oxidation
	Pastiglie non incluse / Brake pads not included
	N° pastiglie x pinza 2 pz / N° of brake pads per caliper 2 pcs
	Contenuto confezione pinza singola / Pack contents single brake calipers (L or R)

■ Accessori di ricambio (venduti singolarmente) / Spare parts (sold individually)

Codice Reference	Descrizione Description
AGPA134ST	Pastiglie freno miscela sinterizzata (4 pz x blister) / Brake pad with sintered compound (4pcs x blister)
AGPA134OR	Pastiglie freno miscela organica (2 pz x blister) / Brake pad with organic compound (2pcs x blister)
AGPA134ZXC	Pastiglie freno miscela racing (4 pz x blister) / Brake pad with racing compound (4 pcs x blister)
AGPA134EV2	Pastiglie freno miscela racing (2 pz x blister) / Brake pad with racing compound (2 pcs x blister)
PT295	Pistone in titanio autoventilato, Ø 29,5 / Titanium-made, self-ventilated piston, Ø29,5
VP295	Guarnizione pistone Ø 29,5 / Ø29,5 piston seal
AGPET	Perno in titanio / Titanium pin
AGM01	Molla anti-vibrazioni / Anti-rattle spring
AGFS	Fermo di sicurezza / Safety catch
RC012	Valvola di spurgo M8x1 / Bleeding valve M8x1

BRAKE/CLUTCH
MASTER CYLINDERS
 ACCESSORIES
SPARE PARTS
 CNC-WORKED FLUID
RESERVOIR
 FULL CLUTCH
 HYDRAULIC-CLUTCH
TRANFORMATION KIT
 LEVER
 THROTTLE CONTROL
 BRAKE CALIPER
 RACING KIT
 BUTTON PANEL
 LEVER GUARD
 CLIP-ON
 STREET RACING
REARSET
 FUEL CAPS
 STEERING NUT
 CRASH PADS
 PADDOCK STAND
 MIRROR COVERS
 REAR-VIEW MIRRORS
 FOG LIGHTS KIT
 HANDLEBARS
ACCESSORIES
 HANDLEBARS

PINZA FRENO RADIALE

RADIAL BRAKE CALIPER



Colori pinze / Calipers colours

A ●	N ●	R ●	H ●
antracite - charcoal	nero - black	rosso - red	ossido duro naturale hard anodising

Pinza freno radiale / Radial brake caliper

Codice Reference	Caratteristiche tecniche Technical details
PZ009	Interasse / Distance: 60mm
	Off-set: 23,7 mm
	Pistoncini alluminio Ergal D34mm / Small pistons ergal aluminium D34mm
	Guarnizione parapolvere / Dust seal: Si / Yes
	Pastiglie / Brake pads: n° 2 pastiglie x pinza / n° 2 of brake pads per caliper: AGPA42OR/ST
	Contenuto confezione pinza singola / Pack contents single brake caliper
	Supporto non incluso / Bracket not included

Accessori di ricambio (venduti singolarmente) / Spare parts (sold individually)

Codice Reference	Descrizione Description
PA034	Pistone in alluminio, Ø 34 / Ø 34 aluminium pin
UP034	Guarnizione pistone Ø 34 / Ø 34 piston seal
GP034	Guarnizione parapolvere Ø 34 / Ø 34 dust seal
AGPEI	Perno Inox / Stainless steel pin
AGM01	Molla anti-vibrazioni / Anti-rattle spring
AGFS	Fermo di sicurezza / Safety catch
RC012	Valvola di spurgo M8x1 / Bleeding valve M8x1
AGPA42OR	Pastiglie freno mescola organica (2 pz x blister) / Brake pads with organic compound (2 pcs x blister)
AGPA42ST	Pastiglie freno mescola organica (2 pz x blister) / Brake pads with road use compound (2 pcs x blister)

Note: Versione radiale Pinza Brembo cod. 20B85270

Note: Radial Version of Brembo Brake Caliper , cod. 20B85270

- BRAKE/CLUTCH MASTER CYLINDERS
- ACCESSORIES SPARE PARTS
- CNC-WORKED FLUID RESERVOIR
- FULL CLUTCH
- HYDRAULIC-CLUTCH TRANFORMATION KIT
- LEVER
- THROTTLE CONTROL
- BRAKE CALIPER
- RACING KIT
- BUTTON PANEL
- LEVER GUARD
- CLIP-ON
- STREET RACING REARSET
- FUEL CAPS
- STEERING NUT
- CRASH PADS
- PADDOCK STAND
- MIRROR COVERS
- REAR-VIEW MIRRORS
- FOG LIGHTS KIT
- HANDLEBARS ACCESSORIES
- HANDLEBARS

APPLICAZIONI PINZE FRENO / APPLICATION LIST BRAKE CALIPER

■ Pinze freno int. 108 mm / 108 mm distance Brake caliper

Applicazioni / Application list

Marca Brand	Cc	Modello Model	Anno dal From	Anno al To	Codice Code	N° Omologazione Homologation number	Novità New
HONDA	600	CBR600 RR	2005	2006	INT. 108	E4*0190*	
HONDA	600	CBR600 RR	2007	2016	INT. 108	E4*1247*	
HONDA	1000	CBR1000 RR FIREBLADE	2004	2007	INT. 108	E4*0269*	
HONDA	1000	CBR1000 RR FIREBLADE	2006	2007	INT. 108	E4*0269*	
HONDA	1000	CBR1000 RRFIREBLADE	2008	2015	INT. 108	E4*1726*	
HONDA	1000	CBR 1000 RR	2006	2019	INT. 108		N
HONDA	1000	CBR 1000 RR SP	2014	2019	INT. 108		N
KAWASAKI	600	ZX-6R NINJA	2007	2016	INT. 108	E4*1274*	
KAWASAKI	600	ZX-6RR NINJA	2003	2019	INT. 108	E4*0364*	
KAWASAKI	636	ZX-6R NINJA 636	2003	2004	INT. 108	E1*0571*	N
KAWASAKI	636	ZX-6R NINJA 636	2005	2006	INT. 108	E1*0229*	
KAWASAKI	750	Z750R	2011	2014	INT. 108	E1*0487*	
KAWASAKI	1000	H2R	2015	2016	INT. 108		
KAWASAKI	1000	Z1000	2014	2019	INT. 108		N
KAWASAKI	1000	Z1000	2007	2013	INT. 108	E1*0172*	
KAWASAKI	1000	Z1000SX	2011	2013	INT. 108		
KAWASAKI	1000	ZX-10R NINJA	2004	2005	INT. 108	E4*0246*	
KAWASAKI	1000	ZX-10R NINJA	2006	2010	INT. 108	E1*0270*	
KAWASAKI	1000	ZX-10R NINJA	2008	2015	INT. 108		
KAWASAKI	1200	ZX-12R NINJA	2002	2006	INT. 108		N
KAWASAKI	1400	GTR 1400	2008	2018	INT. 108	E1*0647*	N
KAWASAKI	1400	ZX-14R	2006	2015	INT. 108		
KAWASAKI	1400	ZZR 1400	2006	2007	INT. 108	E4*0912*	N
KAWASAKI	1400	ZZR 1400 ABS	2006	2020	INT. 108	E4*0912*	N
SUZUKI	600	GSX R 600	2004	2005	INT. 108	E4*0253*	
SUZUKI	600	GSX R 600	2006	2007	INT. 108	E4*0849*	
SUZUKI	600	GSX R 600	2008	2017	INT. 108	E4*1756*	
SUZUKI	750	GSX R 750	2004	2005	INT. 108	E4*0261*	
SUZUKI	750	GSX R 750	2008	2017	INT. 108	E4*1852*	
SUZUKI	1000	GSX R 1000	2003	2004	INT. 108	E4*0193*	
SUZUKI	1000	GSX R 1000	2005	2006	INT. 108	E4*0375*	
SUZUKI	1000	GSX R 1000	2007	2015	INT. 108	E4*1343*	
SUZUKI	1300	GSX 1300 B-KING	2008	2015	INT. 108	E4*1531*	
SUZUKI	1300	GSX R 1300 R HAYABUSA	2006	2017	INT. 108		
SUZUKI	600	GSX R 600	2016	2019	INT. 108		N
SUZUKI	750	GSX R 750	2006	2007	INT. 108	E4*0890*	
SUZUKI	750	GSX R 750	2016	2019	INT. 108		N
SUZUKI	1000	GSX R 1000	2016	2019	INT. 108		N
SUZUKI	1000	GSX S 1000 / KATANA	2016	2019	INT. 108		N
SUZUKI	1300	GSX R 1300 R HAYABUSA	1999	2005	INT. 108		
SUZUKI	1300	GSX R 1300 R HAYABUSA	2016	2019	INT. 108		N
SUZUKI	1300	GSX R 1300 R HAYABUSA	2008	2012	INT. 108		N
YAMAHA	600	YZF R46	2005	2005	INT. 108		N
YAMAHA	600	YZF R6	2005	2019	INT. 108	E13*0073*	
YAMAHA	847	FZ-09	2014	2015	INT. 108		
YAMAHA	850	MT-09	2017	2019	INT. 108		N
YAMAHA	900	TRACER 900	2015	2019	INT. 108		N
YAMAHA	900	TRACER 900	2018	2019	INT. 108		N
YAMAHA	900	XSR 900	2016	2019	INT. 108		N
YAMAHA	1000	YZF R1	2004	2006	INT. 108	E13*0084	
YAMAHA	1000	YZF R1 SP	2006	2006	INT. 108	E13*0084*	
YAMAHA	1000	MT-10	2016	2019	INT. 108		N
YAMAHA	1000	YZF R1 M	2016	2019	INT. 108		N
YAMAHA	1000	YZF R1	2015	2019	INT. 108		N
YAMAHA	1700	MT-01	2007	2009	INT. 108		N
YAMAHA	1700	V-MAX	2009	2016	INT. 108		N

Nota: queste pinze possono essere montate ed adattate su altre moto, con pinze freno originali con interasse 108
 Note: these brake caliper can be fitted on other motorbikes, whose oem brake caliper with distance 108

BRAKE/CLUTCH
 MASTER CYLINDERS
 ACCESSORIES
 SPARE PARTS
 CNC-WORKED FLUID
 RESERVOIR
 FULL CLUTCH
 HYDRAULIC-CLUTCH
 TRANFORMATION KIT
 LEVER
 THROTTLE CONTROL
 BRAKE CALIPER
 RACING KIT
 BUTTON PANEL
 LEVER GUARD
 CLIP-ON
 STREET RACING
 REARSET
 FUEL CAPS
 STEERING NUT
 CRASH PADS
 PADDOCK STAND
 MIRROR COVERS
 REAR-VIEW MIRRORS
 FOG LIGHTS KIT
 HANDLEBARS
 ACCESSORIES
 HANDLEBARS

■ Pinze freno int. 100 mm / 100 mm distance Brake caliper

Applicazioni / Application list

Marca Brand	Cc	Modello Model	Anno dal From	Anno al To	N° Omologazione Homologation number	Novità New
APRILIA	750	DORSODURO 750	2008	2016		N
APRILIA	750	DORSODURO 750 FACTORY	2010	2013		N
APRILIA	750	SHIVER	2007	2013	E11*0619*	N
APRILIA	750	SHIVER SL GT	2009	-	E11*0619*	N
APRILIA	750	SL750 SHIVER	2007	2013	E11*0619*	
APRILIA	850	MANA 850	2007	2011	E11*0663*	
APRILIA	900	DORSODURO 900	2017	2018		N
APRILIA	1000	RK RSV 4 FACTORY APRC ABS	2013	2014	E11*0749*	N
APRILIA	1000	RSV 1000 / R	2000	2003	E11*0027*	
APRILIA	1000	RSV 1000 TUONO FIGHTER R	2002	2005	E11*0027*	
APRILIA	1000	RSV 4 FACTORY	2009	--	E11*0749*	N
APRILIA	1000	RSV 4 FACTORY APRC	2011	2012	E11*0749*	N
APRILIA	1000	RSV 4 R	2009	--	E11*0749*	N
APRILIA	1000	RSV 4 R APRC	2011	2014	E11*0749*	N
APRILIA	1000	RSV MILLE R	2003	2004	E11*0093*	
APRILIA	1000	RSV MILLE R	2005	--	E11*0093*	
APRILIA	1000	RSV MILLE R FACTORY	2004	2008	E11*0093*	
APRILIA	1000	RSV MILLE R NERA	2003	2004	E11*0093*	
APRILIA	1000	RSV4 RACING FACTORY LE	2015	2016		N
APRILIA	1000	RSV4 RR	2015	2019		N
APRILIA	1000	RSV4 RR RACER PACK	2015	2015		N
APRILIA	1000	TUONO	2006	2009	E11*1156*	
APRILIA	1000	TUONO V4 R	2011	2014	E11*1156*	
APRILIA	1100	TUONO V4 RR	2015	--	E11*1156*	
APRILIA	1100	TUONO V4 FACTORY	2017	2018		N
APRILIA	1200	DORSODURO 1200	2010	2016		N
BENELLI	899	TNT 899	2008	2009	E3*0259*	N
BENELLI	899	TNT 899 CENTURY RACER	2011	2014	E3*0259*	N
BENELLI	899	TNT 899 S	2008	2009	E3*0259*	N
BENELLI	899	TRE-K 899	2009	2009	E1*0312*	N
BENELLI	899	TRE-K 899 M.Y.	2012	2014	E1*0312*	N
BENELLI	900	TORNADO RS	2004	2005		N
BENELLI	1130	TNT 1130	2004	2006	E3*0259*	N
BENELLI	1130	TNT 1130 CAFÉ RACER	2004	--	E3*0259*	
BENELLI	1130	TNT 1130 CAFE RACER -	2010	2010	E3*0259*	N
BENELLI	1130	TNT 1130 SPORT	2004	2005	E3*0259*	
BENELLI	1130	TNT 1130 SPORT EVO	2007	2007	E3*0259*	N
BENELLI	1130	TNT 1130 TITANIUM	2005	2007	E3*0259*	
BENELLI	1130	TNT R 160	2010	2014	E3*0259*	N
BENELLI	1130	TNT SPORT	2004	2006		N
BENELLI	1130	TRE-K 1130	2007	2008	E1*0312*	N
BENELLI	1130	TRE-K 1130 AMAZONAS	2007	2012	E1*0312*	N
BENELLI	1130	TRE-K 1130 M.Y.	2011	2012	E1*0312*	N
BIMOTA	992	DB5	2005	2013	E11*0251*	
BIMOTA	992	DB6	2006	2013	E11*0443*	
BIMOTA	1000	DB5 R	2011	2013		N
BIMOTA	1078	DB10	2012	2013		N
BIMOTA	1078	TESI 3D EVO	2011	2014		N
BIMOTA	1198	DB8	2011	2013		N
BIMOTA	1198	DB9 BRIVIDO S	2012	2013		N
BMW	1000	HP4	2013	2014	E1*0421*	
BMW	1000	S1000R	2013	2019	E1*0421*	
BMW	1000	S1000RR	2009	2019	E1*0421*	
BMW	1000	S1000 XR	2017	2019		N
DUCATI	696	MONSTER 696	2008	2014	E3*0497*	
DUCATI	696	MONSTER 696 ABS	2010	2013		
DUCATI	749	749 R	2004	2007		N
DUCATI	796	HYPERMOTARD 796	2009	2012		

BRAKE/CLUTCH
 MASTER CYLINDERS
 ACCESSORIES
 SPARE PARTS
 CNC-WORKED FLUID
 RESERVOIR
 FULL CLUTCH
 HYDRAULIC-CLUTCH
 TRANFORMATION KIT
 LEVER
 THROTTLE CONTROL
 BRAKE CALIPER
 RACING KIT
 BUTTON PANEL
 LEVER GUARD
 CLIP-ON
 STREET RACING
 REARSET
 FUEL CAPS
 STEERING NUT
 CRASH PADS
 PADDOCK STAND
 MIRROR COVERS
 REAR-VIEW MIRRORS
 FOG LIGHTS KIT
 HANDLEBARS
 ACCESSORIES
 HANDLEBARS

Marca Brand	Cc	Modello Model	Anno dal From	Anno al To	N° Omologazione Homologation number	Novità New
DUCATI	796	MONSTER 796 ABS	2010	2015		
DUCATI	797	MONSTER 797 / 797 PLUS	2017	2019		N
DUCATI	800	SCRAMBLER CAFE RACER	2017	2020		N
DUCATI	800	SCRAMBLER CLASSIC	2015	2018		N
DUCATI	800	SCRAMBLER DESERT SLEED	2017	2002		N
DUCATI	800	SCRAMBLER ICON	2015	2020		N
DUCATI	800	SCRAMBLER MACH 2.0 / STREET CLASSIC	2018	2018		N
DUCATI	803	MONSTER 796	2010	2015	E3*0496*	
DUCATI	821	HYPERMOTARD 821	2013	2015	E3*0600*	
DUCATI	821	HYPERMOTARD 821 SP	2013	2015	E3*0600*	
DUCATI	821	HYPERSTRADA 821	2013	2015	E3*0601*	
DUCATI	821	MONSTER 821 / 821 DARK	2015	2019		N
DUCATI	821	MONSTER 821 STEALTH	2019	2019		N
DUCATI	821	MONSTER 821 STRIPES	2015	2017		N
DUCATI	848	848	2008	2015		
DUCATI	848	848 EVO	2011	2013		N
DUCATI	899	899 PANIGALE	2013	2015		
DUCATI	936	SUPERSPORT 936 / 936 S	2017	2019		N
DUCATI	939	HYPERMOTARD 939	2016	2018		N
DUCATI	939	HYPERMOTARD 939 SP / SP U	2016	2018		N
DUCATI	950	HYPERMOTARD 950 / 950 SP / 950 SP U	2019	2019		N
DUCATI	950	MULTISTRADA 950	2017	2020		N
DUCATI	950	MULTISTRADA 950 S TOURING	2019	2020		N
DUCATI	950	MULTISTRADA 950 SW / S	2018	2020		N
DUCATI	950	MULTISTRADA 950 TOURING	2017	2018		N
DUCATI	959	959 PANIGALE CORSE / U	2018	2019		N
DUCATI	998	MONSTER S4R / S4RS	2003	2008	E3*0281*	
DUCATI	999	999 R/S	2002	2007		
DUCATI	1000	DESMOSEDICI RR	2008	2008		N
DUCATI	1098	1098 R	2007	2009	E3*0436*02	
DUCATI	1099	1098	2007	2009	E3*0436*	
DUCATI	1099	1098 S	2007	2009	E3*0436*	
DUCATI	1099	HYPERMOTARD 1100 EVO SP	2007	2012	E3*0470	
DUCATI	1099	STREETFIGHTER	2009	2015	E3*0436*	
DUCATI	1099	STREETFIGHTER S	2009	2015	E3*0436*	
DUCATI	1100	HYPERMOTARD 1100	2007	2012	E3*0470	
DUCATI	1100	HYPERMOTARD 1100 S	2007	2012	E3*0470	
DUCATI	1100	MONSTER 1100	2009	2012	E3*0497*	
DUCATI	1100	MONSTER 1100 ABS	2009	2012		
DUCATI	1100	MONSTER 1100 S	2009	2012	E3*0497*	
DUCATI	1100	SCRAMBLER 1100	2018	2018		N
DUCATI	1100	SCRAMBLER 1100 SPECIAL	2018	2019		N
DUCATI	1103	PANIGALE V4	2018	2019		N
DUCATI	1103	PANIGALE V4 S	2018	2019		N
DUCATI	1103	PANIGALE V4 SPECIALE	2018	2019		N
DUCATI	1198	DIAVEL	2011	2015	E3*0575*	
DUCATI	1198	MULTISTRADA 1200	2010	2015	E3*0563*	
DUCATI	1199	1198	2009	2011	E3*0436*03	
DUCATI	1199	1198 R	2009	--	E3*0436*03	
DUCATI	1199	1198 S	2009	2010	E3*0436*03	
DUCATI	1199	1199 PANIGALE / PANIGALE R / PANIGALE S	2013	2014		N
DUCATI	1199	1199 PANIGALE R	2015	2017		N
DUCATI	1200	DIAVEL CARBON	2011	2013		N
DUCATI	1200	DIAVEL CARBON FL	2015	2018		N
DUCATI	1200	DIAVEL CROMO	2013	2013		N
DUCATI	1200	DIAVEL FL	2015	2018		N
DUCATI	1200	DIAVEL STRADA	2013	2014		N
DUCATI	1200	DIAVEL TITANIUM	2015	2015		N

BRAKE/CLUTCH
MASTER CYLINDERS
 ACCESSORIES
SPARE PARTS
 CNC-WORKED FLUID
RESERVOIR
 FULL CLUTCH
 HYDRAULIC-CLUTCH
TRANFORMATION KIT
 LEVER
 THROTTLE CONTROL
 BRAKE CALIPER
 RACING KIT
 BUTTON PANEL
 LEVER GUARD
 CLIP-ON
 STREET RACING
REARSET
 FUEL CAPS
 STEERING NUT
 CRASH PADS
 PADDOCK STAND
 MIRROR COVERS
 REAR-VIEW MIRRORS
 FOG LIGHTS KIT
 HANDLEBARS
ACCESSORIES
 HANDLEBARS

Marca Brand	Cc	Modello Model	Anno dal From	Anno al To	N° Omologazione Homologation number	Novità New
DUCATI	1200	DIAVEL WHITE STRIPE	2013	2014		N
DUCATI	1200	MONSTER 1200	2014	2020	E3*0563*	
DUCATI	1200	MONSTER 1200 R	2018	2019		N
DUCATI	1200	MONSTER 1200 S	2017	2020	E3*0563*	
DUCATI	1200	MULTISTRADA 1200 ABS	2010	2014		N
DUCATI	1200	MULTISTRADA 1200 ENDURO	2018	2018		N
DUCATI	1200	MULTISTRADA 1200 S GT	2013	2014		N
DUCATI	1200	MULTISTRADA 1200 S PIKES PEAK	2012	2014		N
DUCATI	1200	MULTISTRADA 1200 S SPORT	2011	2012		N
DUCATI	1200	MULTISTRADA 1200 S TOURING	2010	2014		N
DUCATI	1200	X DIAVEL SPORT PACK B	2017	2018		N
DUCATI	1260	DIAVEL 1260	2019	2020		N
DUCATI	1260	DIAVEL 1260 S	2019	2020		N
DUCATI	1260	MONSTER 1260 S ABS	2018	2020		N
DUCATI	1260	MULTISTRADA 1260 ABS	2017	2020		N
DUCATI	1260	MULTISTRADA 1260 S D-AIR / PIKES PEAK / TOURING	2018	2020		N
DUCATI	1260	MULTISTRADA 1260 TOURING	2018	2020		N
DUCATI	1260	X DIAVEL	2016	2020		N
DUCATI	1260	X DIAVEL 1260 S	2018	2020		N
DUCATI	1299	1299 PANIGALE	2015	2017		N
DUCATI	1299	1299 PANIGALE R	2017	2018		N
DUCATI	1299	1299 PANIGALE S	2015	2017		N
DUCATI	1299	1299 PANIGALE	2015	--		N
KAWASAKI	1000	Z1000 R EDITION	2017	2019		N
KAWASAKI	1000	ZX-10 R	2016	2019		N
KAWASAKI	1000	ZX-10 RR	2017	2018		N
KTM	950	950 SUPERMOTO	2005	2008	E1*0249*	
KTM	950	950R SUPERMOTO	2005	2008	E1*0249*	
KTM	990	990 SUPERDUKE	2005	2012	E1*0232*	
KTM	990	990 SUPERDUKE R	2007	2012	E1*0232*	
KTM	990	990 SUPERMOTO	2008	--	E1*0249*	
KTM	1190	RC8	2008	2015		
KTM	1190	RC8R	2008	2015		
MONDIAL	999	PIEGA EVO	2003	--	E3*0156*	
MV AGUSTA	675	F3 675	2011	2019		
MV AGUSTA	675	F3 675 ORO	2012	2019	E3*0587*	N
MV AGUSTA	675	BRUTALE 675	2012	2017		N
MV AGUSTA	800	DRAGSTER 800 RR	2012	2017		
MV AGUSTA	800	F3 800	2013	2019		
MV AGUSTA	800	BRUTALE 800	2012	2017		N
MV AGUSTA	800	F3 800 AGO	2013	2019		N
MV AGUSTA	910	F4 BRUTALE R	2005	2019	E3*0024*	
MV AGUSTA	921	BRUTALE	2010	2011	E3*0554*01	N
MV AGUSTA	989	BRUTALE 989	2008	2008		N
MV AGUSTA	990	BRUTALE 990 R	2010	2011		N
MV AGUSTA	1000	F4 1000 R / SENNA	2006	2019	E3*0236*	
MV AGUSTA	1078	BRUTALE 1078	2008	2019	E3*0024*	
MV AGUSTA	1078	BRUTALE CORSA	2013	2015		
MV AGUSTA	1078	F4 1078	2009	2019		
MV AGUSTA	1078	F4 RR	2011	2019		
MV AGUSTA	1090	BRUTALE 1090	2013	2015	E3*0340*	
MV AGUSTA	1090	BRUTALE R	2013	2015	E3*0554*02	N
MV AGUSTA	1090	BRUTALE RR	2013	2015	E3*0554*02	N
MV AGUSTA	1098	BRUTALE 1098	2012	2013		
TRIUMPH	675	DAYTONA 675	2006	2016	E11*0253*	
TRIUMPH	1050	SPEED TRIPLE S	2004	2005	E11*0135*	

Nota: queste pinze possono essere montate ed adattate su altre moto, con pinze freno originali con interasse 100
Note: these brake caliper can be fitted on other motorbikes, whose oem brake caliper with distance 100

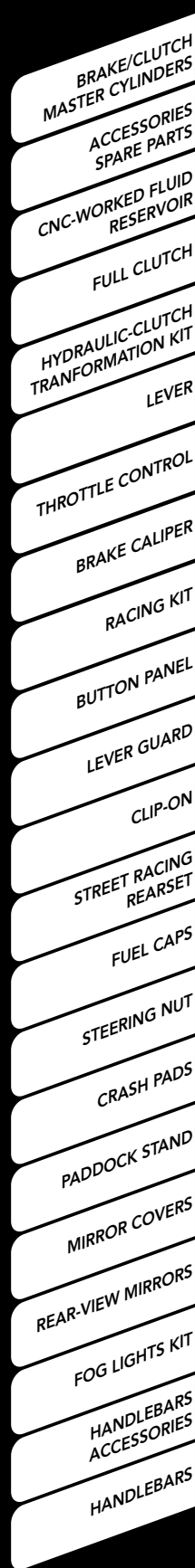

DISTANZIALI

PER PINZE FRENO RADIALI ANTERIORI

FRONT RADIAL CALIPER SPACERS



- BRAKE/CLUTCH MASTER CYLINDERS
- ACCESSORIES SPARE PARTS
- CNC-WORKED FLUID RESERVOIR
- FULL CLUTCH
- HYDRAULIC-CLUTCH TRANSFORMATION KIT
- LEVER
- THROTTLE CONTROL
- BRAKE CALIPER
- RACING KIT
- BUTTON PANEL
- LEVER GUARD
- CLIP-ON
- STREET RACING REARSET
- FUEL CAPS
- STEERING NUT
- CRASH PADS
- PADDOCK STAND
- MIRROR COVERS
- REAR-VIEW MIRRORS
- FOG LIGHTS KIT
- HANDLEBARS ACCESSORIES
- HANDLEBARS

Codice Code	Specifiche tecniche Technical specifications
DS001	H= 7,5mm
DS002	H= 8,5mm
DS003	H= 10,5mm
DS007	solo viti H= 60mm / only screw H= 60mm

Applicazioni per disco originale / OEM brake rotor application list

Marca Brand	Cc	Modello Model	Anno dal From	Anno al To	Codice Code	Novità New
HONDA	1000	CBR 1000 RR	2004	2016	DS007	N
KAWASAKI	600	ZX-6R	2005	2016	DS007	N
KAWASAKI	636	ZX-6R 636	2013	2019	DS002	
KAWASAKI	1000	ZX-10R	2008	2010	DS002	
KAWASAKI	1000	ZX-10R	2011	2015	DS002	
KAWASAKI	1000	ZX-10R	2004	2007	DS007	N
KAWASAKI	1400	ZX-14R	2006	2018	DS002	
SUZUKI	600	GSX R 600	2006	2007	DS002	
SUZUKI	600	GSX R 600	2008	2010	DS002	
SUZUKI	600	GSX R 600	2011	2017	DS002	
SUZUKI	600	GSX-R 600/750	2004	2005	DS007	N
SUZUKI	750	GSX R 750	2006	2007	DS002	
SUZUKI	750	GSX R 750	2008	2010	DS002	
SUZUKI	750	GSX R 750	2011	2017	DS002	
SUZUKI	1000	GSX R 1000	2005	2006	DS002	
SUZUKI	1000	GSX R 1000	2007	2008	DS002	
SUZUKI	1000	GSX R 1000	2009	2011	DS003	
SUZUKI	1000	GSX R 1000	2012	2016	DS003	
SUZUKI	1000	GSX R 1000	2003	2004	DS007	N
SUZUKI	1300	GSX R 1300	2008	2012	DS003	
TRIUMPH	675	DAYTONA 675	2009	2012	DS001	N
TRIUMPH	1050	SPEED TRIPLE S	2005	2007	DS002	
YAMAHA	600	YZF-R6	2008	2015	DS001	
YAMAHA	600	YZF-R6	2017	2019	DS001	
YAMAHA	600	YZF-R46	2005	2005	DS001	N
YAMAHA	600	YZF-R6	2005	2005	DS001	
YAMAHA	600	YZF-R6	2006	2007	DS001	
YAMAHA	850	MT-09	2014	2019	DS001	N
YAMAHA	900	TRACER 900	2018	2019	DS001	N
YAMAHA	900	TRACER 900 GT	2018	2019	DS001	N
YAMAHA	900	XSR 900	2016	2019	DS001	N
YAMAHA	1000	MT-10	2017	2019	DS001	
YAMAHA	1000	YZF-R1	2015	2019	DS001	
YAMAHA	1000	YZF-R1	2004	2006	DS001	
YAMAHA	1000	YZF-R1 SP	2006	--	DS001	

DS001

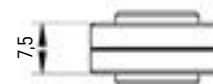

DS002

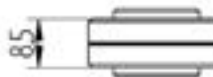

DS003



- BRAKE/CLUTCH MASTER CYLINDERS
- ACCESSORIES SPARE PARTS
- CNC-WORKED FLUID RESERVOIR
- FULL CLUTCH
- HYDRAULIC-CLUTCH TRANFORMATION KIT
- LEVER
- THROTTLE CONTROL
- BRAKE CALIPER
- RACING KIT
- BUTTON PANEL
- LEVER GUARD
- CLIP-ON
- STREET RACING REARSET
- FUEL CAPS
- STEERING NUT
- CRASH PADS
- PADDOCK STAND
- MIRROR COVERS
- REAR-VIEW MIRRORS
- FOG LIGHTS KIT
- HANDLEBARS ACCESSORIES
- HANDLEBARS

Codice Code	Specifiche tecniche Technical specifications
DS003	H= 10,5mm
DS004	H= 12,5mm
DS005	H= 13,5mm
DS006	H= 15,5mm

Applicazioni per disco maggiorato / Oversize brake rotor 320 mm application list

Marca Brand	Cc	Modello Model	Anno dal From	Anno al To	Codice Code	Novità New
KAWASAKI	600	ZX-6R	2009	2016	DS003	
KAWASAKI	600	ZX-6R	2007	2008	DS003	
KAWASAKI	600	ZX-6R/RR	2005	2006	DS003	
KAWASAKI	600	ZX-6R	2009	2016	DS006	
KAWASAKI	600	ZX-6R	2007	2008	DS006	
KAWASAKI	600	ZX-6R/RR	2005	2006	DS006	
KAWASAKI	636	ZX-6R 636	2013	2019	DS005	
KAWASAKI	1000	Z1000	2014	2020	DS003	
KAWASAKI	1000	Z1000	2017	2020	DS003	
KAWASAKI	1000	Z1000 R EDITION	2017	2020	DS003	
KAWASAKI	1000	ZX-10R	2004	2007	DS003	
KAWASAKI	1000	ZX-10R	2004	2007	DS003	
KAWASAKI	1000	Z1000	2007	2009	DS003	
KAWASAKI	1000	Z1000	2010	2013	DS003	
KAWASAKI	1000	ZX-10R	2008	2010	DS005	
KAWASAKI	1000	ZX-10R	2011	2015	DS005	
KAWASAKI	1000	ZX-10R	2004	2007	DS006	
KAWASAKI	1000	ZX-10R	2004	2007	DS006	
KAWASAKI	1400	ZX-14R	2006	2018	DS005	
SUZUKI	600	GSX R 600	2006	2007	DS005	
SUZUKI	600	GSX R 600	2008	2010	DS005	
SUZUKI	600	GSX R 600	2011	2017	DS005	
SUZUKI	750	GSX R 750	2006	2007	DS005	
SUZUKI	750	GSX R 750	2008	2010	DS005	
SUZUKI	750	GSX R 750	2011	2017	DS005	
SUZUKI	1000	GSX R 1000	2005	2006	DS005	
SUZUKI	1000	GSX R 1000	2007	2008	DS005	
SUZUKI	1000	GSX R 1000	2009	2011	DS006	
SUZUKI	1000	GSX R 1000	2012	2016	DS006	
SUZUKI	1300	GSX R 1300	2008	2012	DS006	
YAMAHA	600	YZF-R6	2008	2015	DS004	
YAMAHA	600	YZF-R6	2017	2019	DS004	
YAMAHA	600	YZF-R46	2005	--	DS004	N
YAMAHA	600	YZF-R6	2005	2018	DS004	
YAMAHA	600	YZF-R6	2005	--	DS004	
YAMAHA	600	YZF-R6	2006	2007	DS004	

DS003



DS004



DS005



DS006



- BRAKE/CLUTCH MASTER CYLINDERS
- ACCESSORIES SPARE PARTS
- CNC-WORKED FLUID RESERVOIR
- FULL CLUTCH
- HYDRAULIC-CLUTCH TRANFORMATION KIT
- LEVER
- THROTTLE CONTROL
- BRAKE CALIPER
- RACING KIT
- BUTTON PANEL
- LEVER GUARD
- CLIP-ON
- STREET RACING REARSET
- FUEL CAPS
- STEERING NUT
- CRASH PADS
- PADDOCK STAND
- MIRROR COVERS
- REAR-VIEW MIRRORS
- FOG LIGHTS KIT
- HANDLEBARS ACCESSORIES
- HANDLEBARS

KIT FLANGE FRENO

BRAKE-FLANGES KIT

T-MAX



BMW



MOTARD



Codice Reference	Descrizione Description	Caratteristiche tecniche Technical details	Applicazioni Application list
FL001	Flangia freno T-Max T-Max brake flange	<ul style="list-style-type: none"> Staffe per pinze radiali interasse 100 mm / Brackets for radial brake calipers, distance 100 mm Colore nero / Colour black Contenuto confezione: Flangia Dx + Flangia SX / Packaging: R. flange + L. flange 	Yamaha T-Max 500 2008 - 2014 Yamaha T-Max 530 2008 - 2014
Codice Reference	Descrizione Description	Applicazioni Applications	Applicazioni Applications
FL002	Flangia sx / Left flange	<ul style="list-style-type: none"> Staffe per pinze radiali interasse 108 mm / Brackets for radial brake calipers, distance 108 mm Colore nero / Colour black Contenuto confezione: Flangia Sx / Packaging: L. flange 	Yamaha 250 dal 2010 al 2014 Yamaha 450 dal 2010 al 2014
Codice Reference	Descrizione Description	Caratteristiche tecniche Technical details	Applicazioni Application list
FL003	Flangia freno BMW BMW brake flange	<ul style="list-style-type: none"> Staffe per pinze radiali / brackets for radial brake calipers: Interasse 100 mm / Distance 100 mm Colore / colour: Nero / Black Contenuto confezione / Packaging: Flangia Dx + Flangia Sx: R. flange + L. flange 	BMW R1200S 2006 - 2007

Modello Model

Questo kit realizzato interamente in CNC permette la trasformazione delle pinze freno originali, da assiali a radiali. La modifica dell'impianto frenante migliorerà la potenza di frenata della vostra moto, rendendola più decisa e sicura. N.B. Potrebbe essere necessaria la modifica delle tubazioni originali.

Totally CNC-worked, this kit allows the transformation of original brake calipers from axial into radial ones. By modifying your braking system, you will certainly improve the grip. N.B. modifications onto original brake lines might be necessary.

- BRAKE/CLUTCH MASTER CYLINDERS
- ACCESSORIES SPARE PARTS
- CNC-WORKED FLUID RESERVOIR
- FULL CLUTCH
- HYDRAULIC-CLUTCH TRANSFORMATION KIT
- LEVER
- THROTTLE CONTROL
- BRAKE CALIPER
- RACING KIT
- BUTTON PANEL
- LEVER GUARD
- CLIP-ON
- STREET RACING REARSET
- FUEL CAPS
- STEERING NUT
- CRASH PADS
- PADDOCK STAND
- MIRROR COVERS
- REAR-VIEW MIRRORS
- FOG LIGHTS KIT
- HANDLEBARS ACCESSORIES
- HANDLEBARS

KIT RACING



Codice Reference	Descrizione Description
---------------------	----------------------------

KITA1	Kit pompa freno radiale Ø 19 con leva snodata (tutte le pompe 19X eccetto PRS) + comando elettrico registro leva Master cylinder kit Ø 19 (all m. cyl. Ø 19 except for PRS) with folding lever + electric remote adjuster
-------	--



Codice Reference	Descrizione Description
---------------------	----------------------------

KITA2	Pompa radiale Accossato Ø 19 con leva snodata (tutte le pompe 19X eccetto PRS) + comando frizione Accossato CF002 Accossato master cylinder Ø 19 (all m. cyl. Ø 19 except for PRS) with folding lever + full clutch CF002
-------	--

- BRAKE/CLUTCH MASTER CYLINDERS
- ACCESSORIES SPARE PARTS
- CNC-WORKED FLUID RESERVOIR
- FULL CLUTCH
- HYDRAULIC-CLUTCH TRANSFORMATION KIT
- LEVER
- THROTTLE CONTROL
- BRAKE CALIPER
- RACING KIT
- BUTTON PANEL
- LEVER GUARD
- CLIP-ON
- STREET RACING REARSET
- FUEL CAPS
- STEERING NUT
- CRASH PADS
- Paddock STAND
- MIRROR COVERS
- REAR-VIEW MIRRORS
- FOG LIGHTS KIT
- HANDLEBARS ACCESSORIES
- HANDLEBARS



Codice
Reference

Descrizione
Description

KITA3

Pompa freno Ø 19 con leva fissa + supporto specchio (spec. M8 o M10X1,25) + idrostop + kit vaschetta 30 ml
 Ø 19 brake master cylinder with fix lever + mirror holder (M8 or M10X1,25) + hydraulic brake light switch + 30 ml fluid reservoir-kit



Codice
Reference

Descrizione
Description

KITA4

Pompa freno Ø 19 con leva snodata (tutte le pompe 19 eccetto PRS) + supporto specchio (spec. M8 o M10X1,25) + idrostop + kit vaschetta 30 ml
 Ø 19 brake master cylinder with folding lever (all m. cyl. Ø 19 except for PRS) + mirror holder (M8 or M10X1,25) + hydraulic brake light switch + 30 ml fluid reservoir-kit



Codice
Reference

Descrizione
Description

KITA21

Kit pompa freno radiale "Ready to brake" con leva snodata + controllo remoto
 "Ready to brake" master cylinder kit with folding lever + remote adjuster

New

- BRAKE/CLUTCH MASTER CYLINDERS
- ACCESSORIES SPARE PARTS
- CNC-WORKED FLUID RESERVOIR
- FULL CLUTCH
- HYDRAULIC-CLUTCH TRANFORMATION KIT
- LEVER
- THROTTLE CONTROL
- BRAKE CALIPER
- RACING KIT
- BUTTON PANEL
- LEVER GUARD
- CLIP-ON
- STREET RACING REARSET
- FUEL CAPS
- STEERING NUT
- CRASH PADS
- PADDOCK STAND
- MIRROR COVERS
- REAR-VIEW MIRRORS
- FOG LIGHTS KIT
- HANDLEBARS ACCESSORIES
- HANDLEBARS

SGANCIO RAPIDO TUBO FRENO

BRAKE-HOSE QUICK DISCONNECT



Codice Reference	Descrizione Description	Colore Colour	Passo del filetto Screw thread
BL001	Sgancio rapido tubo freno in titanio <i>Brake-hose quick disconnect, titanium-made</i>	N ● nero - black	3/8" - 24
BL002	Sgancio rapido tubo freno in alluminio <i>Brake-hose quick disconnect, aluminium-made</i>	N ● nero - black	3/8" - 24
BL003	Sgancio rapido tubo freno in titanio <i>Brake-hose quick disconnect, titanium-made</i>	R ● rosso - red	3/8" - 24
BL006	Sgancio rapido tubo freno in alluminio <i>Brake-hose quick disconnect, aluminium-made</i>	R ● rosso - red	3/8" - 24
BL004	Sgancio rapido tubo freno in alluminio <i>Brake-hose quick disconnect, aluminium-made</i>	Y ● oro - gold	3/8" - 24

- BRAKE/CLUTCH MASTER CYLINDERS
- ACCESSORIES SPARE PARTS
- CNC-WORKED FLUID RESERVOIR
- FULL CLUTCH
- HYDRAULIC-CLUTCH TRANSFORMATION KIT
- LEVER
- THROTTLE CONTROL
- BRAKE CALIPER
- RACING KIT
- BUTTON PANEL
- LEVER GUARD
- CLIP-ON
- STREET RACING REARSET
- FUEL CAPS
- STEERING NUT
- CRASH PADS
- Paddock STAND
- MIRROR COVERS
- REAR-VIEW MIRRORS
- FOG LIGHTS KIT
- HANDLEBARS ACCESSORIES
- HANDLEBARS

PULSANTIERE BUTTON PANEL



BRAKE/CLUTCH
MASTER CYLINDERS

ACCESSORIES
SPARE PARTS

CNC-WORKED FLUID
RESERVOIR

FULL CLUTCH

HYDRAULIC-CLUTCH
TRANSFORMATION KIT

LEVER

THROTTLE CONTROL

BRAKE CALIPER

RACING KIT

BUTTON PANEL

LEVER GUARD

CLIP-ON

STREET RACING
REARSET

FUEL CAPS

STEERING NUT

CRASH PADS

Paddock STAND

MIRROR COVERS

REAR-VIEW MIRRORS

FOG LIGHTS KIT

HANDLEBARS
ACCESSORIES

HANDLEBARS

■ Pulsantiera destra 2 pulsanti Plug & Play / 2-key Plug & Play button panels

Marca Brand	CC	Modello Model	Anno dal From	Anno al To	Codice Reference
DUCATI	848	STREETFIGHTER	2013	2015	PS011
DUCATI	848	STREETFIGHTER	2013	2019	PS013
DUCATI	848	SUPERBIKE 848 EVO	2013	2019	PS011
DUCATI	848	SUPERBIKE 848 EVO	2013	2019	PS013
DUCATI	899	PANIGALE ABS	2014	2019	PS010
DUCATI	959	PANIGALE ABS	2017	2019	PS010
DUCATI	1098	STREETFIGHTER S	2013	2019	PS011
DUCATI	1098	STREETFIGHTER S	2013	2019	PS013
DUCATI	1199	PANIGALE S ABS	2014	2019	PS011
DUCATI	1199	PANIGALE ABS	2015	2019	PS010
DUCATI	1199	PANIGALE ABS	2014	2019	PS011
DUCATI	1199	PANIGALE ABS	2014	2019	PS013
DUCATI	1199	PANIGALE R	2013	2019	PS010
DUCATI	1199	PANIGALE R	2013	2017	PS010
DUCATI	1199	PANIGALE R	2015	2019	PS011
DUCATI	1199	PANIGALE R	2015	2019	PS013
DUCATI	1199	PANIGALE S ABS	2015	2019	PS010
DUCATI	1199	PANIGALE S ABS	2014	2019	PS013
DUCATI	1199	PANIGALE SUPERLEGGERA	2014	2019	PS010
DUCATI	1299	PANIGALE ABS	2017	2019	PS010

■ Pulsantiera destra 3 pulsanti Plug & Play / 3-key Plug & Play button panels

Marca Brand	CC CC	Modello Model	Anno dal From	Anno al To	Versione stradale / Street Version		Versione Racing / Racing Version	
					Pompa freno Accossato Master Cylinder Accossato	Pompa freno Brembo Racing Master Cylinder Brembo racing	Pompa freno Accossato Master Cylinder Accossato	Pompa freno Brembo Racing Master Cylinder Brembo racing
APRILIA	1000	RSV4 / RR / TUONO RR / RF	2017	2019	PS020	PS032	PS020	PS032
BMW	1000	S RR	2015	2018	PS021	PS033	PS044	PS047
BMW	1000	S RR	2019	2019			PS044	PS047
DUCATI	821	MONSTER	2017	2019	PS022	PS034	PS022	PS034
DUCATI	959	PANIGALE	2016	2019	PS022	PS034	PS022	PS034
DUCATI	1000	PANIGALE V4 R	2019	2019	PS042	PS043	PS042	PS043
DUCATI	1100	PANIGALE V4 / S	2018	2019	PS023	PS041	PS023	PS041
DUCATI	1299	PANIGALE	2015	2018	PS022	PS034	PS022	PS034
HONDA	1000	CBR RR	2017	2018	PS024	PS035	PS045	PS048
KAWASAKI	400	NINJA	2018	2019	PS025	PS036	PS025	PS036
KAWASAKI	1000	ZX-10R NINJA / RR	2016	2019	PS026	PS037	PS026	PS037
MV AGUSTA	1000	F4 RC	2015	2018	PS027	PS038	PS027	PS038
SUZUKI	1000	GSX-R	2017	2019	PS028	PS039	PS028	PS039
YAMAHA	300	YZF-R3	2019	2019			PS046	PS049
YAMAHA	300	YZF-R3	2015	2018	PS030		PS030	
YAMAHA	600	YZF-R6	2017	2019	PS031	PS040	PS031	PS040
YAMAHA	600	YZF-R6 MECTRONIK	2017	2019	PS031	PS040	PS031	PS040
YAMAHA	1000	YZF-R1	2015	2019	PS029		PS029	
YAMAHA	1000	YZF-R1M	2015	2019	PS029		PS029	

BRAKE/CLUTCH
MASTER CYLINDERS
 ACCESSORIES
SPARE PARTS
 CNC-WORKED FLUID
RESERVOIR
 FULL CLUTCH
 HYDRAULIC-CLUTCH
TRANFORMATION KIT
 LEVER
 THROTTLE CONTROL
 BRAKE CALIPER
 RACING KIT
 BUTTON PANEL
 LEVER GUARD
 CLIP-ON
 STREET RACING
REARSET
 FUEL CAPS
 STEERING NUT
 CRASH PADS
 PADDOCK STAND
 MIRROR COVERS
 REAR-VIEW MIRRORS
 FOG LIGHTS KIT
 HANDLEBARS
ACCESSORIES
 HANDLEBARS

■ Pulsantiera sinistra Plug & Play / Plug & Play Button panels

Marca Brand	CC	Modello Model	Anno dal From	Anno al To	Versione stradale Street Version	Codice Reference		
						n°pulsanti n° buttons	Versione racing Racing Version	n°pulsanti n° buttons
APRILIA	1000	RSV4 / RR / TUONO RR / RF	2017	2019			PS068	5 TASTI
DUCATI	796		2010	2012	PS050	7 TASTI		
DUCATI	821	HYPERMOTARD	2013	2015	PS050	7 TASTI		
DUCATI	821	MONSTER	2017	2019	PS050	7 TASTI		
DUCATI	821	MONSTER	2013	2016	PS050	7 TASTI		
DUCATI	848	STREETFIGHTER	2013	2015	PS050	7 TASTI		
DUCATI	899	PANIGALE	2014	2015	PS050	7 TASTI	PS015	5 TASTI
DUCATI	959	PANIGALE	2016	2019	PS050	7 TASTI	PS014	5 TASTI
DUCATI	1098	STREETFIGHTER / S	2010	2013	PS050	7 TASTI		
DUCATI	1100	HYPERMOTARD EVO / SP	2010	2012	PS050	7 TASTI		
DUCATI	1199	PANIGALE	2012	2017	PS050	7 TASTI	PS014	5 TASTI
DUCATI	1199	PANIGALE	2013	2017	PS012	7 TASTI		
DUCATI	1200	DIAVEL	2011	2016	PS050	7 TASTI		
DUCATI	1200	MONSTER / S	2017	2019	PS050	7 TASTI		
DUCATI	1200	MONSTER / S	2014	2016	PS050	7 TASTI		
DUCATI	1200	MONSTER R	2016	2019	PS050	7 TASTI		
DUCATI	1299	PANIGALE	2015	2018	PS050	7 TASTI	PS014	5 TASTI
HONDA	1000	CBR RR	2017	2018	PS051	8 TASTI	PS060	5 TASTI
KAWASAKI	400	NINJA	2018	2019	PS052	5 TASTI		
KAWASAKI	1000	ZX-10R NINJA / RR	2016	2019	PS053	7 TASTI	PS061	5 TASTI
MV AGUSTA	675	BRUTALE	2012	2017	PS054	6 TASTI	PS062	5 TASTI
MV AGUSTA	675	F3	2012	2018	PS054	6 TASTI	PS062	5 TASTI
MV AGUSTA	800	BRUTALE RR / DRAGSTER	2012	2017	PS054	6 TASTI	PS062	5 TASTI
MV AGUSTA	800	F3	2012	2018	PS054	6 TASTI	PS062	5 TASTI
MV AGUSTA	800	RIVALE	2014	2016	PS054	6 TASTI	PS062	5 TASTI
MV AGUSTA	920	BRUTALE	2010	2011	PS054	6 TASTI	PS062	5 TASTI
MV AGUSTA	1000	F4 R	2010	2015	PS054	6 TASTI	PS062	5 TASTI
MV AGUSTA	1000	F4 RC	2015	2018	PS054	6 TASTI	PS062	5 TASTI
MV AGUSTA	1000	F4 RR	2010	2015	PS054	6 TASTI	PS062	5 TASTI
MV AGUSTA	1090	BRUTALE 1090RR / R	2012	2015	PS054	6 TASTI	PS062	5 TASTI
SUZUKI	1000	GSX-R	2017	2019	PS055	5 TASTI	PS063	5 TASTI
YAMAHA	300	YZF-R3	2015	2018	PS057	7 TASTI		
YAMAHA	1000	YZF-R1	2015	2019	PS056	7 TASTI	PS064	5 TASTI
YAMAHA	1000	YZF-R1M	2015	2019	PS056	5 TASTI	PS064	5 TASTI





Codice Reference	Descrizione Description	Caratteristiche tecniche Technical details		
PS001	Pulsantiera 2 pulsanti 2-key button panel	Lato destro / Right side Funzioni / Functions → Lunghezza cavo / Cable L.: 55 cm Connettore / Connector: N/P Peso / Weight: ≈ 70 gr Cavallotto / Riser: No		Bistabile Bistable
PS006	Pulsantiera 2 pulsanti personalizzabile (compilare l'apposita scheda) ¹ Customized 2-key button panel (specific form to fill in) ¹	Lato dx o sx / r. or l. side Funzioni personalizzabili / Customizable functions: vedi opzioni scheda1 / see form options1 Lunghezza cavo / Cable L.: 55 cm Connettore / Connector: N/P Peso / Weight: ≈ 70 gr *Cavallotto / Riser: No		Monostabile Monostable
Descrizione Description		Compatibile con pompe freno Suitable for brake m. cyl.		

* Non fornita di cavallotto: si assembla direttamente alla pompa freno, al posto del bracciale originale
Assembly to master cylinder directly, in place of original riser.

Accosato
Brembo RCS
→ Originali, interasse fori 30-32 mm / OEM, bolt pattern 30-32 mm

■ Pulsantiera 2 pulsanti per pompa Brembo modello PR
Button panel for Brembo Master Cylinder PR model
(a due fori di fissaggio non in asse /
with two not in axis fixing holes not in)

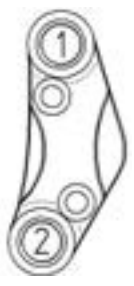

Codice Reference	Descrizione Description	Caratteristiche tecniche Technical details		
PS007	Pulsantiera 2 pulsanti 2-key button panel	Lato destro / Right side Funzioni / Functions → Lunghezza cavo / Cable L.: 55 cm Connettore / Connector: N/P Peso / Weight: ≈ 70 gr Cavallotto / Riser: No		Bistabile Bistable
PS008	Pulsantiera 2 pulsanti personalizzabile (compilare l'apposita scheda) ¹ Customized 2-key button panel (specific form to fill in) ¹	Lato dx o sx / r. or l. side Funzioni personalizzabili / Customizable functions: vedi opzioni scheda1 / see form options1 Lunghezza cavo / Cable L.: 55 cm Connettore / Connector: N/P Peso / Weight: ≈ 70 gr *Cavallotto / Riser: No		Monostabile Monostable
Descrizione Description		Compatibile con pompe freno Suitable for brake m. cyl.		

* Non fornita di cavallotto: si assembla direttamente alla pompa freno, al posto del bracciale originale
Assembly to master cylinder directly, in place of original riser.

Brembo PR

- BRAKE/CLUTCH MASTER CYLINDERS
- ACCESSORIES SPARE PARTS
- CNC-WORKED FLUID RESERVOIR
- FULL CLUTCH
- HYDRAULIC-CLUTCH TRANFORMATION KIT
- LEVER
- THROTTLE CONTROL
- BRAKE CALIPER
- RACING KIT
- BUTTON PANEL
- LEVER GUARD
- CLIP-ON
- STREET RACING REARSET
- FUEL CAPS
- STEERING NUT
- CRASH PADS
- PADDOCK STAND
- MIRROR COVERS
- REAR-VIEW MIRRORS
- FOG LIGHTS KIT
- HANDLEBARS ACCESSORIES
- HANDLEBARS



Codice Reference	Descrizione Description	Caratteristiche tecniche Technical details
---------------------	----------------------------	---

PS002	Pulsantiera 3 pulsanti 3-key button panel	Lato sinistro / Left side Funzioni / Functions → Lunghezza cavo / Cable L.: 55 cm Connettore / Connector: N/P Peso / Weight: ≈ 95 gr Cavallotto / Riser: Sì / Yes
-------	--	--

Codice Reference	Descrizione Description	Caratteristiche tecniche Technical details
---------------------	----------------------------	---

PS003	Pulsantiera 3 pulsanti personalizzabile (compilare l'apposita scheda) ¹ Customized 3-key button panel (specific form to fill in) ¹	Lato dx o sx / r. or l. side Funzioni personalizzabili / Customizable functions: vedi opzioni scheda1 / see form options1 Lunghezza cavo / Cable L.: 55 cm Connettore / Connector: N/P Peso / Weight: ≈ 95 gr *Cavallotto / Riser: Sì / Yes
-------	---	--



Bistabile
Bistable

Monostabile
Monostable

Monostabile
Monostable



Codice Reference	Descrizione Description	Caratteristiche tecniche Technical details
---------------------	----------------------------	---

PS004	Pulsantiera 5 pulsanti 5-key button panel	Lato sinistro / Left side Funzioni / Functions → Lunghezza cavo / Cable L.: 55 cm Connettore / Connector: N/P Peso / Weight: ≈ 145 gr Cavallotto / Riser: Sì / Yes
-------	--	---

Codice Reference	Descrizione Description	Caratteristiche tecniche Technical details
---------------------	----------------------------	---

PS005	Pulsantiera 5 pulsanti personalizzabile (compilare l'apposita scheda) ¹ Customized 5-key button panel (specific form to fill in) ¹	Lato dx o sx / r. or l. side Funzioni personalizzabili / Customizable functions: vedi opzioni scheda1 / see form options1 Lunghezza cavo / Cable L.: 55 cm Connettore / Connector: N/P Peso / Weight: ≈ 95 gr *Cavallotto / Riser: Sì / Yes
-------	---	--

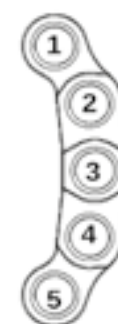

Monostabile
Monostable

Monostabile
Monostable

Monostabile
Monostable

Bistabile
Bistable

Monostabile
Monostable

- BRAKE/CLUTCH MASTER CYLINDERS
- ACCESSORIES SPARE PARTS
- CNC-WORKED FLUID RESERVOIR
- FULL CLUTCH
- HYDRAULIC-CLUTCH TRANFORMATION KIT
- LEVER
- THROTTLE CONTROL
- BRAKE CALIPER
- RACING KIT
- BUTTON PANEL
- LEVER GUARD
- CLIP-ON
- STREET RACING REARSET
- FUEL CAPS
- STEERING NUT
- CRASH PADS
- Paddock STAND
- MIRROR COVERS
- REAR-VIEW MIRRORS
- FOG LIGHTS KIT
- HANDLEBARS ACCESSORIES
- HANDLEBARS

PARALEVA "DEFLECTOR" LEVER GUARD

DE001-DE005



DE011-DE013



DE006-DE010



Colori / Colours

N  nero - black

O  arancione orange

Y  oro - gold

B  blu - blue

R  rosso - red

S  argento - silver

G  verde - green

- BRAKE/CLUTCH MASTER CYLINDERS
- ACCESSORIES SPARE PARTS
- CNC-WORKED FLUID RESERVOIR
- FULL CLUTCH
- HYDRAULIC-CLUTCH TRANSFORMATION KIT
- LEVER
- THROTTLE CONTROL
- BRAKE CALIPER
- RACING KIT
- BUTTON PANEL
- LEVER GUARD
- CLIP-ON
- STREET RACING REARSET
- FUEL CAPS
- STEERING NUT
- CRASH PADS
- PADDOCK STAND
- MIRROR COVERS
- REAR-VIEW MIRRORS
- FOG LIGHTS KIT
- HANDLEBARS ACCESSORIES
- HANDLEBARS

Codice Reference	Descrizione Description	Varianti tubo Hose variants
DE001	Paraleva Accossato dx tubo in alluminio Accossato right handguard, aluminium hose	Tubo dritto / Tubo piegato a 90° Straight hose / 90° bent hose
DE002	Paraleva Accossato sx tubo in alluminio Accossato left handguard, aluminium hose	Tubo dritto / Tubo piegato a 90° Straight hose / 90° bent hose
DE003	Paraleva Accossato dx+sx tubo in alluminio Accossato left+right handguard, aluminium hose	Tubo dritto / Tubo piegato a 90° Straight hose / 90° bent hose
DE004	Paraleva Accossato dx tubo in alluminio + terminale sx Accossato right handguard, aluminium hose + left end	Tubo dritto / Tubo piegato a 90° Straight hose / 90° bent hose
DE005	Paraleva Accossato sx tubo in alluminio + terminale dx Accossato left handguard, aluminium hose + right end	Tubo dritto / Tubo piegato a 90° Straight hose / 90° bent hose
DE006	Paraleva Accossato dx tubo in carbonio Accossato right handguard, carbon hose	Tubo dritto / Tubo piegato a 90° Straight hose / 90° bent hose
DE007	Paraleva Accossato sx tubo in carbonio Accossato left handguard, carbon hose	Tubo dritto / Tubo piegato a 90° Straight hose / 90° bent hose
DE008	Paraleva Accossato dx+sx tubo in carbonio Accossato left+right handguard, carbon hose	Tubo dritto / Tubo piegato a 90° Straight hose / 90° bent hose
DE009	Paraleva Accossato dx tubo in carbonio + terminale sx Accossato right handguard, carbon hose + left end	Tubo dritto / Tubo piegato a 90° Straight hose / 90° bent hose
DE010	Paraleva Accossato sx tubo in carbonio + terminale dx Accossato left handguard, carbon hose + right end	Tubo dritto / Tubo piegato a 90° Straight hose / 90° bent hose
DE011	Paraleva destro Accossato, "Ultra Light" realizzato in carbonio Accossato "Ultra Light" right handguard, carbon-made	
DE012	Paraleva sinistro Accossato, "Ultra Light" realizzato in carbonio Accossato "Ultra Light" left handguard, carbon-made	
DE013	Paraleva Accossato Dx+SX, "Ultra light" realizzato in carbonio Accossato "Ultra Light" right/left handguard, carbon-made	

Spiegazione Explanation

Il paraleva "Deflector" è stato studiato per garantire la massima sicurezza dei piloti durante le gare. Deflector protegge la leva freno e frizione, da qualsiasi contatto accidentale con altri veicoli. La ricercatezza nello sviluppo ha permesso di ridurre al minimo l'incidenza aerodinamica. Il paraleva "Deflector" può essere regolato in lunghezza e lateralmente, attraverso adattatori. Compatibile per tutti i manubri con diametro interno da 12 a 20 mm.

The "Deflector" handguard was designed to guarantee the total safety for the racers during the races. Deflector safeguard the clutch lever and the brake one from any kind of dangerous contact with other vehicles. The research during the planning of this product led up to the reduction of the aerodynamics incidence. The "Deflector" handguard can be extend laterally and in lenght by adaptors, Deflector is suitable for any handlebar from 12 to 20 mm.

Ricambi / Spare parts

Codice Reference	Descrizione Description
RC049-12	Attacco Ø12-16 per paraleva in carbonio DE011-DE013 Ø 12-16 fittings for carbon fiber handguards DE011-DE013
RC049-16	Attacco Ø16-17,5 per paraleva in carbonio DE011-DE013 Ø 16-17,5 fittings for carbon fiber handguards DE011-DE013
RC067	Ricambio aletta Paraleva destro Accossato, "Ultra Light" realizzato in carbonio per DE011-DE013 Spare flap for Accossato "Ultra Light" right handguard, carbon-made DE011-DE013
RC068	Ricambio aletta Paraleva sinistro Accossato, "Ultra Light" realizzato in carbonio per DE011-DE013 Spare left flap Accossato, "Ultra Light" made of carbon for DE011-DE013

Note: colori selezionabili da B2B / Colors selectable from B2b

BRAKE/CLUTCH
MASTER CYLINDERS
ACCESSORIES
SPARE PARTS
CNC-WORKED FLUID
RESERVOIR
FULL CLUTCH
HYDRAULIC-CLUTCH
TRANFORMATION KIT
LEVER
THROTTLE CONTROL
BRAKE CALIPER
RACING KIT
BUTTON PANEL
LEVER GUARD
CLIP-ON
STREET RACING
REARSET
FUEL CAPS
STEERING NUT
CRASH PADS
PADDOCK STAND
MIRROR COVERS
REAR-VIEW MIRRORS
FOG LIGHTS KIT
HANDLEBARS
ACCESSORIES
HANDLEBARS

SEMI MANUBRI REGOLABILI ADJUSTABLE CLIP-ON



Codice Reference	Descrizione Description	Per forcelle Ø Fits forks Ø	Note Notes
CP001	Semi-manubrio regolabile con inclinazione da 6° a 10°, con guscio Adjustable clip-on with inclination from 6° to 10°, with inner ring	48mm - 50 mm - 51 mm - 52 mm 53 mm - 55 mm	Colore gusci: nero Inner ring color: black
CP002	Semi-manubrio regolabile con inclinazione da 6° a 10°, senza guscio Adjustable clip-on with inclination from 6° to 10°, no inner ring		

Codice Reference	Descrizione Description	Per forcelle Ø Fits forks Ø	Colore guscio Inner ring colour
GU048	Coppia di gusci per semi-manubri a diametro intercambiabile Pair of inner rings for cli-on with adjustable diameter	48mm - 50 mm - 51 mm 52 mm - 53 mm - 55 mm	N ● nero - black
GU050			
GU051			
GU052			
GU053			
GU055			

Colori tubo semimanubrio / Clip-on colours

N ●
nero - black

O ●
arancione
orange

Y ●
oro - gold

B ●
blu - blue

R ●
rosso - red

S ●
argento - silver

G ●
verde - green

CP001 Applicazioni / Application list

Marca Brand	Cc	Modello Model	Anno dal From	Anno al To	Ø Forcella Fork Ø	Novità New	Marca Brand	Cc	Modello Model	Anno dal From	Anno al To	Ø Forcella Fork Ø	Novità New
APRILIA	250	RS REPLICA	1995	2003	50MM		DUCATI	848	848 EVO H6	2008	2013	53MM	
APRILIA	1000	RSV RR	2004	2004	51MM		DUCATI	888	888 S	1993	1996	50MM	
APRILIA	1000	RSV4 R APRC RK	2011	2011	51MM		DUCATI	900	SUPERSPORT SS	1993	1993	50MM	
APRILIA	1000	RSV4 R RK	2010	2010	51MM		DUCATI	900	MONSTER	1993	2002	50MM	
APRILIA	1000	RSV4 RF APRC	2015	2015	51MM		DUCATI	900	SUPERSPORT I.E.	1998	2002	50MM	
APRILIA	1000	RSV4 RR	2015	2015	51MM		DUCATI	900	900 SS/S	1991	1998	50MM	
APRILIA	1000	RSV4 RACING FACTORY LE	2015	2018	50MM	N	DUCATI	916	SPORT TOURING ST2	1997	2003	50MM	N
APRILIA	1000	RSV4 RR RACER PACK	2015	2018	50MM	N	DUCATI	916	MONSTER S4	2001	2002	50MM	N
APRILIA	1000	RSV4 FACTORY APRC RK	2011	2014	51MM		DUCATI	916	SPORT TOURING ST4	1999	2002	50MM	N
APRILIA	1000	RSV4 FACTORY RK	2010	2012	51MM		DUCATI	916	916	1994	1998	53MM	
APRILIA	1000	RSV4/FACTORY/APRC	2009	2012	50MM		DUCATI	916	916 SPS	1997	1998	53MM	
APRILIA	1000	RSV R FACTORY RR	2004	2010	51MM		DUCATI	959	PANIGALE	2018	2019	53MM	N
APRILIA	1000	RSV R	1998	2009	53MM		DUCATI	959	PANIGALE CORSE	2018	2019	53MM	N
APRILIA	1000	RSV/FACTORY	2006	2009	50MM		DUCATI	996	MONSTER S4R	2003	2006	50MM	
APRILIA	1000	TUONO	1999	2008	53MM		DUCATI	996	996 SPS H1	1997	2001	53MM	
APRILIA	1000	RSV R TUONO	2002	2005	51MM	N	DUCATI	998	PANIGALE V4	2018	2019	53MM	N
APRILIA	1000	SL FALCO PA	2000	2005	51MM		DUCATI	998	PANIGALE V4 S	2018	2019	53MM	N
APRILIA	1000	RSV	1998	2003	53MM		DUCATI	998	PANIGALE V4 R	2018	2019	53MM	N
APRILIA	1000	RSV R RP / ME	2000	2003	51MM		DUCATI	998	998 S H2	2001	2004	53MM	
APRILIA	1000	RSV RP	2001	2003	53MM		DUCATI	998	998 H2	2001	2003	53MM	
APRILIA	1000	RSV ME	1998	2000	53MM		DUCATI	999	999, S,R,BIPOSTO	2002	2006	53MM	
BMW	1000	HP RR K10	2013	2013	55MM		DUCATI	1000	RR FIREBLAD SP	2014	2014	53MM	
BMW	1000	HP4	2013	2013	55MM		DUCATI	1000	SUPERSPORT I.E.	2003	2006	50MM	
BMW	1000	RR K10	2009	2009	55MM		DUCATI	1000	MONSTER 1000	2003	2005	50MM	N
BMW	1000	S RR K10	2009	2009	55MM		DUCATI	1098	1098, R, S H7	2007	2009	53MM	
BMW	1000	S1000 RR	2009	2016	55MM		DUCATI	1198	DIAVEL	2011	2013	53MM	
DUCATI	400	MONSTER	1995	1997	50MM	N	DUCATI	1198	1198, S, SP, R	2009	2011	53MM	
DUCATI	400	MONSTER SS	1993	1997	50MM	N	DUCATI	1199	PANIGALE	2012	2012	53MM	
DUCATI	400	SUPERSPORT SS	1993	1997	50MM	N	DUCATI	1199	PANIGALE R	2013	2017	53MM	
DUCATI	600	MONSTER	1993	1997	50MM		DUCATI	1199	PANIGALE S	2012	2013	53MM	
DUCATI	600	MONSTER SS	1991	1997	50MM	N	HONDA	600	CBR RR	2005	2016	48MM	
DUCATI	600	SUPERSPORT SS	1991	1997	50MM	N	HONDA	600	CBR RR ABS	2009	2010	48MM	
DUCATI	620	SUPERSPORT I.E.	2003	2003	50MM		HONDA	900	CBR RR	2002	2002	50MM	
DUCATI	620	MONSTER	2002	2005	50MM		HONDA	900	CBR RR FIREBLADE	2000	2003	50MM	
DUCATI	748	748	1994	1994	53MM		HONDA	900	CBR RR SC 50	2002	2003	50MM	
DUCATI	748	748 H3	2000	2003	53MM		HONDA	900	CBR RR SC 44	2000	2001	50MM	
DUCATI	748	748 S	1995	2002	53MM	N	HONDA	1000	CBR RR SC59	2008	2008	50MM	
DUCATI	748	748 SP	1995	2002	53MM		HONDA	1000	TR SP2 SC45	2002	2002	50MM	
DUCATI	748	748 SPS	1995	2000	53MM		HONDA	1000	CBR RR	2004	2016	50MM	
DUCATI	749	749 R,S H5	2003	2007	53MM		HONDA	1000	CBR FIREBLADE SC57	2004	2007	50MM	
DUCATI	749	749 R	2004	2006	53MM		HONDA	1000	VTR SP2	2002	2007	50MM	
DUCATI	749	749 S	2003	2006	53MM		HONDA	1000	VTR F	2000	2006	50MM	
DUCATI	750	MONSTER	1997	2002	50MM		HONDA	1000	VTR SP1	2000	2006	50MM	
DUCATI	750	SUPERSPORT I.E.	1999	2002	50MM		HONDA	1000	VTR SP1 SC45	2000	2001	50MM	
DUCATI	750	750 SS/SC	1991	1998	50MM		KAWASAKI	400	ZXR	1991	2003	50MM	
DUCATI	750	MONSTER	1996	1997	50MM	N	KAWASAKI	400	ZXR R	1991	2001	50MM	
DUCATI	750	MONSTER SS	1991	1997	50MM	N	KAWASAKI	600	ZX-6R	2009	2019	51MM	
DUCATI	750	SUPERSPORT SS	1991	1997	50MM		KAWASAKI	600	ZX-6R NINJA	2003	2008	50MM	
DUCATI	750	750 SS/S	1993	1994	50MM		KAWASAKI	600	ZX-6RR NINJA	2003	2006	50MM	
DUCATI	800	MONSTER S2R	1993	1993	50MM		KAWASAKI	636	ZX-6R NINJA	2003	2006	50MM	
DUCATI	800	SUPERSPORT I.E.	2003	2005	50MM		KAWASAKI	750	ZX-7 R	1996	2003	52MM	
DUCATI	848	848 S H6	2007	2007	53MM		KAWASAKI	750	ZX-7R NINJA ZX750 P	1995	2002	52MM	

BRAKE/CLUTCH
 MASTER CYLINDERS
 ACCESSORIES
 SPARE PARTS
 CNC-WORKED FLUID
 RESERVOIR
 FULL CLUTCH
 HYDRAULIC-CLUTCH
 TRANFORMATION KIT
 LEVER
 THROTTLE CONTROL
 BRAKE CALIPER
 RACING KIT
 BUTTON PANEL
 LEVER GUARD
 CLIP-ON
 STREET RACING
 REARSET
 FUEL CAPS
 STEERING NUT
 CRASH PADS
 PADDOCK STAND
 MIRROR COVERS
 REAR-VIEW MIRRORS
 FOG LIGHTS KIT
 HANDLEBARS
 ACCESSORIES
 HANDLEBARS

Marca Brand	Cc	Modello Model	Anno dal From	Anno al To	Ø Forcella Fork Ø	Novità New	Marca Brand	Cc	Modello Model	Anno dal From	Anno al To	Ø Forcella Fork Ø	Novità New
KAWASAKI	750	ZXR ZX750/L/M	1991	1995	52MM		SUZUKI	1000	TL R AM	1998	1998	50MM	
KAWASAKI	900	ZX 9R NINJA ZX900B	1994	1997	52MM		SUZUKI	1000	GSXR	2001	2018	50MM	
KAWASAKI	900	ZX-9R	1994	1997	52MM		SUZUKI	1000	GSXR WVCL	2007	2008	50MM	
KAWASAKI	1000	ZX-10R	2008	2019	50MM		SUZUKI	1000	SV, S, N	2003	2008	50MM	
KAWASAKI	1000	ZX-10R NINJA	2006	2007	48MM		SUZUKI	1000	GSXR WVB6	2005	2006	50MM	
KAWASAKI	1000	ZX-10R	2004	2005	52MM	N	SUZUKI	1000	GSXR WVBZ	2003	2004	50MM	
MV AGUSTA	675	F3	2015	2017	50MM		SUZUKI	1000	TL	1997	2003	50MM	
MV AGUSTA	800	F3	2014	2014	50MM		SUZUKI	1000	GSXR WVBL	2001	2002	50MM	
MV AGUSTA	800	RVS #1	2018	2018	50MM	N	SUZUKI	1000	TL R	1998	2002	50MM	
MV AGUSTA	920	BRUTALE	2010	2011	50MM	N	SUZUKI	1000	TL R/S	1997	2001	50MM	
MV AGUSTA	1000	F4	2010	2015	50MM	N	SUZUKI	1000	TL S	1997	2001	50MM	
MV AGUSTA	1090	BRUTALE	2012	2015	50MM	N	SUZUKI	1100	GSXR W GU75C	1993	1997	52MM	
SUZUKI	250	RGV VJ22B	1991	1991	50MM		SUZUKI	1100	GSXR WUGU75C	1993	1997	50MM	
SUZUKI	250	RGV	1991	1992	50MM		SUZUKI	1100	GSXR GV73C	1989	1992	52MM	
SUZUKI	600	GSX-R	2004	2018	50MM		SUZUKI	1300	R HAYABUSA	2005	2012	50MM	
SUZUKI	600	GSXR WVCV	2008	2010	50MM		TRIUMPH	675	DAYTONA H67	2013	2013	50MM	
SUZUKI	600	GSXR WCE	2006	2007	50MM		TRIUMPH	675	DAYTONA D 67 LC	2006	2012	50MM	
SUZUKI	600	GSXR WVB2	2004	2005	50MM		TRIUMPH	675	DAYTONA R	2006	2012	50MM	
SUZUKI	750	C4	2011	2011	50MM		YAMAHA	600	YZF R6	2005	2018	50MM	
SUZUKI	750	GSX-R	1997	2018	50MM		YAMAHA	750	YZF R7	1999	2002	50MM	
SUZUKI	750	GSXR WVCW	2008	2010	50MM		YAMAHA	750	YZF R SP	1993	1998	50MM	
SUZUKI	750	GSXR WVCF	2006	2007	50MM		YAMAHA	750	YZF R	1993	1996	50MM	
SUZUKI	750	GSXR WV34	2004	2005	50MM		YAMAHA	750	YZF R 4HN	1993	1996	50MM	
SUZUKI	750	GSXR WVCB	2000	2003	50MM		YAMAHA	750	YZF SP 4HT	1995	1996	50MM	
SUZUKI	750	GSXR W GR7DB	1998	1999	50MM		YAMAHA	1000	YZF-R1	1998	2018	50MM	
SUZUKI	750	GSXR W GR7BB	1992	1995	50MM		YAMAHA	1000	FZR	1998	2009	50MM	
SUZUKI	750	GSXR GR7AB	1990	1991	50MM		YAMAHA	1000	THUNDERACE	1996	2002	48MM	
SUZUKI	1000	GSXR WWCY	2009	2009	50MM		YAMAHA	1000	FZR UP SIDE D. 3LE	1991	1995	50MM	
SUZUKI	1000	TL AG	1997	1997	50MM								

Nota: questi semi-manubri possono essere montati ed adattati su altre moto, con diametro delle forcelle 48, 50, 51, 52, 53, 55 mm
 Note: these adjustable clip-on can be fitted on other motorbikes, with fork diameter 48, 50, 51, 52, 53, 55 mm

- BRAKE/CLUTCH MASTER CYLINDERS
- ACCESSORIES SPARE PARTS
- CNC-WORKED FLUID RESERVOIR
- FULL CLUTCH
- HYDRAULIC-CLUTCH TRANFORMATION KIT
- LEVER
- THROTTLE CONTROL
- BRAKE CALIPER
- RACING KIT
- BUTTON PANEL
- LEVER GUARD
- CLIP-ON
- STREET RACING REARSET
- FUEL CAPS
- STEERING NUT
- CRASH PADS
- PADDOCK STAND
- MIRROR COVERS
- REAR-VIEW MIRRORS
- FOG LIGHTS KIT
- HANDLEBARS ACCESSORIES
- HANDLEBARS

SEMI MANUBRI CLIP-ON



Codice Reference	Descrizione Description	Per forcelle Ø Fits forks Ø	Colori braccialeto Rings colours
CP003	Semi-manubrio forgiato in alluminio con morsetto di bloccaggio composto da 2 semi-gusci Aluminium-forged clip-on provided with metal clamp composed of 2 half-rings	50 mm - 51 mm 52 mm - 53 mm	N ● nero - black S ● argento - silver

Colori tubi / Rod colours

N ● nero - black	O ● arancione orange	Y ● oro - gold	B ● blu - blue	R ● rosso - red	S ● argento - silver	G ● verde - green
----------------------------	-----------------------------------	--------------------------	--------------------------	---------------------------	--------------------------------	-----------------------------

Note: inclinazione 10° / inclination 10° - Lunghezza tubi / Rods length: 250 mm -280 mm

BRAKE/CLUTCH
 MASTER CYLINDERS
 ACCESSORIES
 SPARE PARTS
 CNC-WORKED FLUID
 RESERVOIR
 FULL CLUTCH
 HYDRAULIC-CLUTCH
 TRANSFORMATION KIT
 LEVER
 THROTTLE CONTROL
 BRAKE CALIPER
 RACING KIT
 BUTTON PANEL
 LEVER GUARD
 CLIP-ON
 STREET RACING
 REARSET
 FUEL CAPS
 STEERING NUT
 CRASH PADS
 PADDOCK STAND
 MIRROR COVERS
 REAR-VIEW MIRRORS
 FOG LIGHTS KIT
 HANDLEBARS
 ACCESSORIES
 HANDLEBARS

CP003 Applicazioni / Application list

Marca Brand	Cc	Modello Model	Anno dal From	Anno al To	Ø Forcella Fork Ø	Novità New	Marca Brand	Cc	Modello Model	Anno dal From	Anno al To	Ø Forcella Fork Ø	Novità New
APRILIA	250	RS REPLICA	1995	2003	50MM		DUCATI	916	SPORT TOURING ST2	1997	2003	50MM	N
APRILIA	1000	RSV RR	2004	2004	51MM		DUCATI	916	MONSTER S4	2001	2002	50MM	N
APRILIA	1000	RSV4 R APRC RK	2011	2011	51MM		DUCATI	916	SPORT TOURING ST4	1999	2002	50MM	N
APRILIA	1000	RSV4 R RK	2010	2010	51MM		DUCATI	916	916	1994	1998	53MM	
APRILIA	1000	RSV4 RF APRC	2015	2015	51MM		DUCATI	916	916 SPS	1997	1998	53MM	
APRILIA	1000	RSV4 RR	2015	2015	51MM		DUCATI	959	PANIGALE	2018	2019	53MM	N
APRILIA	1000	RSV4 RACING FACTORY LE	2015	2018	50MM	N	DUCATI	959	PANIGALE CORSE	2018	2019	53MM	N
APRILIA	1000	RSV4 RR RACER PACK	2015	2018	50MM	N	DUCATI	996	MONSTER S4R	2003	2006	50MM	
APRILIA	1000	RSV4 FACTORY APRC RK	2011	2014	51MM		DUCATI	996	996 SPS H1	1997	2001	53MM	
APRILIA	1000	RSV4 FACTORY RK	2010	2012	51MM		DUCATI	998	PANIGALE V4	2018	2019	53MM	N
APRILIA	1000	RSV4/FACTORY/APRC	2009	2012	50MM		DUCATI	998	PANIGALE V4 S	2018	2019	53MM	N
APRILIA	1000	RSV R FACTORY RR	2004	2010	51MM		DUCATI	998	PANIGALE V4 R	2018	2019	53MM	N
APRILIA	1000	RSV R	1998	2009	53MM		DUCATI	998	998 S H2	2001	2004	53MM	
APRILIA	1000	RSV/FACTORY	2006	2009	50MM		DUCATI	998	998 H2	2001	2003	53MM	
APRILIA	1000	TUONO	1999	2008	53MM		DUCATI	999	999, S,R,BIPOSTO	2002	2006	53MM	
APRILIA	1000	RSV R TUONO	2002	2005	51MM	N	DUCATI	1000	RR FIREBLAD SP	2014	2014	53MM	
APRILIA	1000	SL FALCO PA	2000	2005	51MM		DUCATI	1000	SUPERSPORT I.E.	2003	2006	50MM	
APRILIA	1000	RSV	1998	2003	53MM		DUCATI	1000	MONSTER 1000	2003	2005	50MM	N
APRILIA	1000	RSV R RP / ME	2000	2003	51MM		DUCATI	1098	1098, R, S H7	2007	2009	53MM	
APRILIA	1000	RSV RP	2001	2003	53MM		DUCATI	1198	DIAVEL	2011	2013	53MM	
APRILIA	1000	RSV ME	1998	2000	53MM		DUCATI	1198	1198, S, SP, R	2009	2011	53MM	
DUCATI	400	MONSTER	1995	1997	50MM	N	DUCATI	1199	PANIGALE	2012	2012	53MM	
DUCATI	400	MONSTER SS	1993	1997	50MM	N	DUCATI	1199	PANIGALE R	2013	2014	53MM	
DUCATI	400	SUPERSPORT SS	1993	1997	50MM	N	DUCATI	1199	PANIGALE S	2012	2013	53MM	
DUCATI	600	MONSTER	1993	1997	50MM		HONDA	900	CBR RR	2002	2002	50MM	
DUCATI	600	MONSTER SS	1991	1997	50MM	N	HONDA	900	CBR RR FIREBLADE	2000	2003	50MM	
DUCATI	600	SUPERSPORT SS	1991	1997	50MM	N	HONDA	900	CBR RR SC 50	2002	2003	50MM	
DUCATI	620	SUPERSPORT I.E.	2003	2003	50MM		HONDA	900	CBR RR SC44	2000	2001	50MM	
DUCATI	620	MONSTER	2002	2005	50MM		HONDA	1000	CBR RR SC59	2008	2008	50MM	
DUCATI	748	748	1994	1994	53MM		HONDA	1000	TR SP2 SC45	2002	2002	50MM	
DUCATI	748	748 H3	2000	2003	53MM		HONDA	1000	CBR RR	2004	2016	50MM	
DUCATI	748	748 S	1995	2002	53MM	N	HONDA	1000	CBR FIREBLADE SC57	2004	2007	50MM	
DUCATI	748	748 SP	1995	2002	53MM		HONDA	1000	VTR SP2	2002	2007	50MM	
DUCATI	748	748 SPS	1995	2000	53MM		HONDA	1000	VTR F	2000	2006	50MM	
DUCATI	749	749 R,S H5	2003	2007	53MM		HONDA	1000	VTR SP1	2000	2006	50MM	
DUCATI	749	749 R	2004	2006	53MM		HONDA	1000	VTR SP1 SC45	2000	2001	50MM	
DUCATI	749	749 S	2003	2006	53MM		KAWASAKI	400	ZXR	1991	2003	50MM	
DUCATI	750	MONSTER	1997	2002	50MM		KAWASAKI	400	ZXR R	1991	2001	50MM	
DUCATI	750	SUPERSPORT I.E.	1999	2002	50MM		KAWASAKI	600	ZX-6R	2009	2019	51MM	
DUCATI	750	750 SS/SC	1991	1998	50MM		KAWASAKI	600	ZX-6R NINJA	2003	2008	50MM	
DUCATI	750	MONSTER	1996	1997	50MM	N	KAWASAKI	600	ZX-6RR NINJA	2003	2006	50MM	
DUCATI	750	MONSTER SS	1991	1997	50MM	N	KAWASAKI	636	ZX-6R NINJA	2003	2006	50MM	
DUCATI	750	SUPERSPORT SS	1991	1997	50MM		KAWASAKI	750	ZX-7 R	1996	2003	52MM	
DUCATI	750	750 SS/S	1993	1994	50MM		KAWASAKI	750	ZX-7R NINJA ZX750 P	1995	2002	52MM	
DUCATI	800	MONSTER S2R	1993	1993	50MM		KAWASAKI	750	ZXR ZX750/L/M	1991	1995	52MM	
DUCATI	800	SUPERSPORT I.E.	2003	2005	50MM		KAWASAKI	900	ZX 9R NINJA ZX900B	1994	1997	52MM	
DUCATI	848	848 S H6	2007	2007	53MM		KAWASAKI	900	ZX-9R	1994	1997	52MM	
DUCATI	848	848 EVO H6	2008	2013	53MM		KAWASAKI	1000	ZX-10R	2008	2019	50MM	
DUCATI	888	888 S	1993	1996	50MM		KAWASAKI	1000	ZX-10R	2004	2005	52MM	N
DUCATI	900	SUPERSPORT SS	1993	1993	50MM		MV AGUSTA	675	F3	2015	2017	50MM	
DUCATI	900	MONSTER	1993	2002	50MM		MV AGUSTA	800	F3	2014	2014	50MM	
DUCATI	900	SUPERSPORT I.E.	1998	2002	50MM		MV AGUSTA	800	RVS #1	2018	2018	50MM	N
DUCATI	900	900 SS/S	1991	1998	50MM		MV AGUSTA	920	BRUTALE	2010	2011	50MM	N

BRAKE/CLUTCH
 MASTER CYLINDERS
 ACCESSORIES
 SPARE PARTS
 CNC-WORKED FLUID
 RESERVOIR
 FULL CLUTCH
 HYDRAULIC-CLUTCH
 TRANFORMATION KIT
 LEVER
 THROTTLE CONTROL
 BRAKE CALIPER
 RACING KIT
 BUTTON PANEL
 LEVER GUARD
 CLIP-ON
 STREET RACING
 REARSET
 FUEL CAPS
 STEERING NUT
 CRASH PADS
 PADDOCK STAND
 MIRROR COVERS
 REAR-VIEW MIRRORS
 FOG LIGHTS KIT
 HANDLEBARS
 ACCESSORIES
 HANDLEBARS

Marca Brand	Cc	Modello Model	Anno dal From	Anno al To	Ø Forcella Fork Ø	Novità New	Marca Brand	Cc	Modello Model	Anno dal From	Anno al To	Ø Forcella Fork Ø	Novità New
MV AGUSTA	1000	F4	2010	2015	50MM	N	SUZUKI	1000	GSXR WVBL	2001	2002	50MM	
MV AGUSTA	1090	BRUTALE	2012	2015	50MM	N	SUZUKI	1000	TL R	1998	2002	50MM	
SUZUKI	250	RGV VJ22B	1991	1991	50MM		SUZUKI	1000	TL R/S	1997	2001	50MM	
SUZUKI	250	RGV	1991	1992	50MM		SUZUKI	1000	TL S	1997	2001	50MM	
SUZUKI	600	GSX-R	2004	2018	50MM		SUZUKI	1100	GSXR W GU75C	1993	1997	52MM	
SUZUKI	600	GSXR WVCV	2008	2010	50MM		SUZUKI	1100	GSXR WUGU75C	1993	1997	50MM	
SUZUKI	600	GSXR WVCE	2006	2007	50MM		SUZUKI	1100	GSXR GV73C	1989	1992	52MM	
SUZUKI	600	GSXR WVB2	2004	2005	50MM		SUZUKI	1300	R HAYABUSA	2005	2012	50MM	
SUZUKI	750	C4	2011	2011	50MM		TRIUMPH	675	DAYTONA H67	2013	2013	50MM	
SUZUKI	750	GSX-R	1997	2018	50MM		TRIUMPH	675	DAYTONA D 67 LC	2006	2012	50MM	
SUZUKI	750	GSXR WVCW	2008	2010	50MM		TRIUMPH	675	DAYTONA R	2006	2012	50MM	
SUZUKI	750	GSXR WVCF	2006	2007	50MM		YAMAHA	600	YZF R6	2005	2019	50MM	
SUZUKI	750	GSXR WV34	2004	2005	50MM		YAMAHA	750	YZF R7	1999	2002	50MM	
SUZUKI	750	GSXR WVCB	2000	2003	50MM		YAMAHA	750	YZF R SP	1993	1998	50MM	
SUZUKI	750	GSXR W GR7DB	1998	1999	50MM		YAMAHA	750	YZF R	1993	1996	50MM	
SUZUKI	750	GSXR W GR7BB	1992	1995	50MM		YAMAHA	750	YZF R 4HN	1993	1996	50MM	
SUZUKI	750	GSXR GR7AB	1990	1991	50MM		YAMAHA	750	YZF SP 4HT	1995	1996	50MM	
SUZUKI	1000	GSXR WVCY	2009	2009	50MM		YAMAHA	1000	YZF-R1	1998	2019	50MM	
SUZUKI	1000	TL AG	1997	1997	50MM		YAMAHA	1000	FZR	1998	2009	50MM	
SUZUKI	1000	TL R AM	1998	1998	50MM		YAMAHA	1000	FZR UP SIDE D. 3LE	1991	1995	50MM	
SUZUKI	1000	GSXR	2001	2018	50MM								
SUZUKI	1000	GSXR WVCL	2007	2008	50MM								
SUZUKI	1000	SV, S, N	2003	2008	50MM								
SUZUKI	1000	GSXR WVB6	2005	2006	50MM								
SUZUKI	1000	GSXR WVBZ	2003	2004	50MM								
SUZUKI	1000	TL	1997	2003	50MM								

Nota: questi semi-manubri possono essere montati ed adattati su altre moto, con diametro delle forcelle 50, 51, 52, 53 mm

Note: these adjustable clip-on can be fitted on other motorbikes, with fork diameter 50, 51, 52, 53 mm

- BRAKE/CLUTCH MASTER CYLINDERS
- ACCESSORIES SPARE PARTS
- CNC-WORKED FLUID RESERVOIR
- FULL CLUTCH
- HYDRAULIC-CLUTCH TRANFORMATION KIT
- LEVER
- THROTTLE CONTROL
- BRAKE CALIPER
- RACING KIT
- BUTTON PANEL
- LEVER GUARD
- CLIP-ON
- STREET RACING REARSET
- FUEL CAPS
- STEERING NUT
- CRASH PADS
- PADDOCK STAND
- MIRROR COVERS
- REAR-VIEW MIRRORS
- FOG LIGHTS KIT
- HANDLEBARS ACCESSORIES
- HANDLEBARS

SEMI MANUBRI RIALZATI

RAISED CLIP-ON



Codice Reference	Descrizione Description	Materiale Material	Per forcelle Ø Fits forks Ø	Rialzo Rise	Colori braccialetto Rings colours
CP004	Semi-Manubrio CNC rialzato con inclinazione 10° Lifted clip-on 10° inclination	Ergal 7075	50mm	+10mm +20mm	N ● nero - black S ● argento - silver

Colori tubi / Rod colours

N ●
nero - black

O ●
arancione
orange

Y ●
oro - gold

B ●
blu - blue

R ●
rosso - red

S ●
argento - silver

G ●
verde - green

BRAKE/CLUTCH
MASTER CYLINDERS
 ACCESSORIES
SPARE PARTS
 CNC-WORKED FLUID
RESERVOIR
 FULL CLUTCH
 HYDRAULIC-CLUTCH
TRANFORMATION KIT
 LEVER
 THROTTLE CONTROL
 BRAKE CALIPER
 RACING KIT
 BUTTON PANEL
 LEVER GUARD
 CLIP-ON
 STREET RACING
REARSET
 FUEL CAPS
 STEERING NUT
 CRASH PADS
 PADDOCK STAND
 MIRROR COVERS
 REAR-VIEW MIRRORS
 FOG LIGHTS KIT
 HANDLEBARS
ACCESSORIES
 HANDLEBARS

CP004 Applicazioni / Application list

Marca Brand	Cc	Modello Model	Anno dal From	Anno al To	Ø Forcella Fork Ø	Novità New	Marca Brand	Cc	Modello Model	Anno dal From	Anno al To	Ø Forcella Fork Ø	Novità New
APRILIA	250	RS REPLICA	1995	2003	50MM		MV AGUSTA	675	F3	2015	2017	50MM	
APRILIA	1000	RSV4 RACING FACTORY LE	2015	2018	50MM	N	MV AGUSTA	800	F3	2014	2014	50MM	
APRILIA	1000	RSV4 RR RACER PACK	2015	2018	50MM	N	MV AGUSTA	800	RVS #1	2018	2018	50MM	N
APRILIA	1000	RSV4/FACTORY/APRC	2009	2012	50MM		MV AGUSTA	920	BRUTALE	2010	2011	50MM	N
APRILIA	1000	RSV/FACTORY	2006	2009	50MM		MV AGUSTA	1000	F4	2010	2015	50MM	N
DUCATI	400	MONSTER	1995	1997	50MM	N	MV AGUSTA	1090	BRUTALE	2012	2015	50MM	N
DUCATI	400	MONSTER SS	1993	1997	50MM	N	SUZUKI	250	RGV VJ22B	1991	1991	50MM	
DUCATI	400	SUPERSPORT SS	1993	1997	50MM	N	SUZUKI	250	RGV	1991	1992	50MM	
DUCATI	600	MONSTER	1993	1997	50MM		SUZUKI	600	GSX-R	2004	2018	50MM	
DUCATI	600	MONSTER SS	1991	1997	50MM	N	SUZUKI	600	GSXR WVCV	2008	2010	50MM	
DUCATI	600	SUPERSPORT SS	1991	1997	50MM	N	SUZUKI	600	GSXR WVCE	2006	2007	50MM	
DUCATI	620	SUPERSPORT I.E.	2003	2003	50MM		SUZUKI	600	GSXR WVB2	2004	2005	50MM	
DUCATI	620	MONSTER	2002	2005	50MM		SUZUKI	750	C4	2011	2011	50MM	
DUCATI	750	MONSTER	1997	2002	50MM		SUZUKI	750	GSX-R	1997	2018	50MM	
DUCATI	750	SUPERSPORT I.E.	1999	2002	50MM		SUZUKI	750	GSXR WVCW	2008	2010	50MM	
DUCATI	750	750 SS/SC	1991	1998	50MM		SUZUKI	750	GSXR WVCF	2006	2007	50MM	
DUCATI	750	MONSTER	1996	1997	50MM	N	SUZUKI	750	GSXR WV34	2004	2005	50MM	
DUCATI	750	MONSTER SS	1991	1997	50MM	N	SUZUKI	750	GSXR WVCB	2000	2003	50MM	
DUCATI	750	SUPERSPORT SS	1991	1997	50MM		SUZUKI	750	GSXR W GR7DB	1998	1999	50MM	
DUCATI	750	750 SS/S	1993	1994	50MM		SUZUKI	750	GSXR W GR7BB	1992	1995	50MM	
DUCATI	800	MONSTER S2R	1993	1993	50MM		SUZUKI	750	GSXR GR7AB	1990	1991	50MM	
DUCATI	800	SUPERSPORT I.E.	2003	2005	50MM		SUZUKI	1000	GSXR WVCY	2009	2009	50MM	
DUCATI	888	888 S	1993	1996	50MM		SUZUKI	1000	TL AG	1997	1997	50MM	
DUCATI	900	SUPERSPORT SS	1993	1993	50MM		SUZUKI	1000	TL R AM	1998	1998	50MM	
DUCATI	900	MONSTER	1993	2002	50MM		SUZUKI	1000	GSX-R	2001	2018	50MM	
DUCATI	900	SUPERSPORT I.E.	1998	2002	50MM		SUZUKI	1000	GSX-R WVCL	2007	2008	50MM	
DUCATI	900	900 SS/S	1991	1998	50MM		SUZUKI	1000	SV, S, N	2003	2008	50MM	
DUCATI	916	SPORT TOURING ST2	1997	2003	50MM	N	SUZUKI	1000	GSXR WVB6	2005	2006	50MM	
DUCATI	916	MONSTER S4	2001	2002	50MM	N	SUZUKI	1000	GSXR WVBZ	2003	2004	50MM	
DUCATI	916	SPORT TOURING ST4	1999	2002	50MM	N	SUZUKI	1000	TL	1997	2003	50MM	
DUCATI	996	MONSTER S4R	2003	2006	50MM		SUZUKI	1000	GSXR WVBL	2001	2002	50MM	
DUCATI	1000	SUPERSPORT I.E.	2003	2006	50MM		SUZUKI	1000	TL R	1998	2002	50MM	
DUCATI	1000	MONSTER 1000	2003	2005	50MM	N	SUZUKI	1000	TL R/S	1997	2001	50MM	
HONDA	900	CBR RR	2002	2002	50MM		SUZUKI	1000	TL S	1997	2001	50MM	
HONDA	900	CBR RR FIREBLADE	2000	2003	50MM		SUZUKI	1100	GSXR WUGU75C	1993	1997	50MM	
HONDA	900	CBR RR SC 50	2002	2003	50MM		SUZUKI	1300	R HAYABUSA	2005	2012	50MM	
HONDA	900	CBR RR SC44	2000	2001	50MM		TRIUMPH	675	DAYTONA D 67 LC	2006	2012	50MM	
HONDA	1000	CBR RR SC59	2008	2008	50MM		TRIUMPH	675	DAYTONA H67	2013	2013	50MM	
HONDA	1000	TR SP2 SC45	2002	2002	50MM		TRIUMPH	675	DAYTONA R	2006	2012	50MM	
HONDA	1000	CBR RR	2004	2016	50MM		TRIUMPH	765	STREET TRIPLE RS	-	-	50MM	N
HONDA	1000	CBR FIREBLADE SC57	2004	2007	50MM		YAMAHA	600	YZF R6	2005	2018	50MM	
HONDA	1000	VTR SP2	2002	2007	50MM		YAMAHA	750	YZF R	1993	1996	50MM	
HONDA	1000	VTR F	2000	2006	50MM		YAMAHA	750	YZF R 4HN	1993	1996	50MM	
HONDA	1000	VTR SP1	2000	2006	50MM		YAMAHA	750	YZF R SP	1993	1998	50MM	
HONDA	1000	VTR SP1 SC45	2000	2001	50MM		YAMAHA	750	YZF R7	1999	2002	50MM	
KAWASAKI	400	ZXR	1991	2003	50MM		YAMAHA	750	YZF SP 4HT	1995	1996	50MM	
KAWASAKI	400	ZXR R	1991	2001	50MM		YAMAHA	1000	YZF-R1	1998	2018	50MM	
KAWASAKI	600	ZX-6R NINJA	2003	2008	50MM		YAMAHA	1000	FZR	1998	2009	50MM	
KAWASAKI	600	ZX-6RR NINJA	2003	2006	50MM		YAMAHA	1000	FZR UP SIDE D. 3LE	1991	1995	50MM	
KAWASAKI	636	ZX-6R NINJA	2003	2006	50MM								
KAWASAKI	1000	ZX-10R	2008	2019	50MM								

Nota: questi semi-manubri possono essere montati ed adattati su altre moto, con diametro delle forcelle 50 mm
 Note: these adjustable clip-on can be fitted on other motorbikes, with fork diameter 50 mm



SEMI MANUBRI REGOLABILI ADJUSTABLE CLIP-ON

Semimanubri con predisposizione per
ammortizzatore di sterzo, foro filettato M6
Handlebars with provision for steering damper,
M6 threaded hole



Codice
Reference

Descrizione
Description

Per forcelle Ø
Fits forks Ø

Colori tubi
Rods colours

CP007

Semi-manubrio CNC regolabile dritto con inclinazione da 6° a 10°
Adjustable CNC clip-on with inclination from 6° to 10°

50 mm
48 mm **New**
51 mm **New**

N ● nero - black

BRAKE/CLUTCH
MASTER CYLINDERS

ACCESSORIES
SPARE PARTS

CNC-WORKED FLUID
RESERVOIR

FULL CLUTCH

HYDRAULIC-CLUTCH
TRANSFORMATION KIT

LEVER

THROTTLE CONTROL

BRAKE CALIPER

RACING KIT

BUTTON PANEL

LEVER GUARD

CLIP-ON

STREET RACING
REARSET

FUEL CAPS

STEERING NUT

CRASH PADS

PADOCK STAND

MIRROR COVERS

REAR-VIEW MIRRORS

FOG LIGHTS KIT

HANDLEBARS
ACCESSORIES

HANDLEBARS

Caratteristiche tecniche

Technical details

- Regolabili 6°-10° / *Adjustable 6°-10°*
- Braccialetto a sgancio rapido / *Quick clamp disconnection*
- Semimanubrio con predisposizione per ammortizzatore di sterzo, foro filettato M6 / *Handlebars with provision for steering damper, M6 threaded hole*

CP007 sono plug&play per i seguenti modelli: / *CP007 are plug & play for the following models:*

Marca Brand	Cc	Modello Model	Anno dal From	Anno al To	Ø Forcella Fork Ø	Novità New
Ducati	998	Superleggera V4	2020	2021	50 mm	N
Ducati	998	Panigale V4 R	2019	2020	50 mm	N
Ducati	1100	Panigale 25° Anniversario	2000	2000	50 mm	N
Ducati	1100	Panigale V4	2018	2021	50 mm	N
Ducati	1100	Panigale V4 S	2018	2021	50 mm	N
Ducati	1100	Panigale V4 S CORSE	2019	2020	50 mm	N
Ducati	1100	Panigale V4 SPECIALE	2018	2019	50 mm	N
Ducati	1103	Panigale V4 SP	2021	2021	50 mm	N

Nota: questi semi-manubri possono essere montati ed adattati su altre moto, con diametro delle forcelle 50 / 48 / 51 mm (vedi pagina 115-116 per le applicazioni) e ammortizzatore di sterzo con filetto M6

Note: these adjustable clip-on can be fitted on other motorbikes, with fork diameter 50 / 48 / 51 mm (for application see pages 115-116) and steering damper with M6 thread



SEMI-MANUBRI RIALZATI REGOLABILI

ADJUSTABLE RAISED CLIP-ON



Semimanubrio rialzato di 40 mm rispetto alla posizione originale
Raised clip on of 40 mm compared to original position

- BRAKE/CLUTCH MASTER CYLINDERS
- ACCESSORIES SPARE PARTS
- CNC-WORKED FLUID RESERVOIR
- FULL CLUTCH
- HYDRAULIC-CLUTCH TRANSFORMATION KIT
- LEVER
- THROTTLE CONTROL
- BRAKE CALIPER
- RACING KIT
- BUTTON PANEL
- LEVER GUARD
- CLIP-ON
- STREET RACING REARSET
- FUEL CAPS
- STEERING NUT
- CRASH PADS
- PADOCK STAND
- MIRROR COVERS
- REAR-VIEW MIRRORS
- FOG LIGHTS KIT
- HANDLEBARS ACCESSORIES
- HANDLEBARS

Codice <i>Reference</i>	Descrizione <i>Description</i>	Ø	Applicativo <i>Suitable for</i>
CP005	Semi-manubri rialzati regolabili <i>Adjustable raised clip-on</i>	41 mm	Universali-adattabili per forcelle Ø 41 mm <i>Universal-adjustable for Ø 41 mm-forks</i>
CP006	Semi-manubri rialzati regolabili <i>Adjustable raised clip-on</i>	46 mm	Universali-adattabili per forcelle Ø 46 mm <i>Universal-adjustable for Ø 46 mm-forks</i>

Spiegazione
Explanation

- Realizzati in alluminio forgiato
- Consentono di regolare l'altezza della posizione di guida originale, assecondando le esigenze del pilota
- Aluminium-forged
- They allow to adjust the length of original driving position, according to drivers' needs

CP005 Applicazioni / *Application list*

Marca <i>Brand</i>	CC	Modello <i>Model</i>	Anno dal <i>From</i>	Anno al <i>To</i>	Novità <i>New</i>
SUZUKI	1000	SV 1000 S	2003	2010	N
SUZUKI	1000	SV 1000	2003	2007	N
KAWASAKI	600	ZX6-R	1998	2002	N
KAWASAKI	636	ZX6-R	2002	2002	N
KAWASAKI	900	ZX9-R	1998	2003	N

CP006 Applicazioni / *Application list*

Marca <i>Brand</i>	CC	Modello <i>Model</i>	Anno dal <i>From</i>	Anno al <i>To</i>	Novità <i>New</i>
BMW	650	F650ST STRADA	1993	2001	N
HONDA	250	MC21 NSR250 R / SE / SP	1990	1993	N
HONDA	250	MC28 NSR250 R / SE / SP	1994	1996	N
HONDA	400	NC23 CBR400 RR	1987	1989	N
HONDA	400	NC29 CBR400 RR	1990	1999	N
HONDA	400	NC30 VFR400 R	1990	1991	N
HONDA	400	CB-400 F	1989	1990	N
HONDA	500	CBR 500	2013	2015	N
HONDA	500	CB 500 X	2013	2015	N
HONDA	600	CB 600 F	1998	2004	N
HONDA	600	CBR 600 F2	1992	1994	N
HONDA	600	CBR 600 F3	1995	1998	N
HONDA	750	VFR 750	1991	1997	N
HONDA	800	VFR 800 FI	1998	2001	N
HONDA	1000	CBF 1000	2006	2015	N
HONDA	1000	CBR 1000 F	1993	1996	N
KAWASAKI	600	ZX-6 R	1995	1997	N
KAWASAKI	600	ZZR 600	1993	2002	N
KAWASAKI	650	ER6 N	2006	2015	N
KAWASAKI	650	ER6 F	2006	2015	N
KAWASAKI	750	Z750	2004	2006	N
KAWASAKI	750	Z750 S	2005	2006	N

BRAKE/CLUTCH
MASTER CYLINDERS
 ACCESSORIES
SPARE PARTS
 CNC-WORKED FLUID
RESERVOIR
 FULL CLUTCH
 HYDRAULIC-CLUTCH
TRANFORMATION KIT
 LEVER
 THROTTLE CONTROL
 BRAKE CALIPER
 RACING KIT
 BUTTON PANEL
 LEVER GUARD
 CLIP-ON
 STREET RACING
REARSET
 FUEL CAPS
 STEERING NUT
 CRASH PADS
 PADDOCK STAND
 MIRROR COVERS
 REAR-VIEW MIRRORS
 FOG LIGHTS KIT
 HANDLEBARS
ACCESSORIES
 HANDLEBARS

Marca Brand	CC	Modello Model	Anno dal From	Anno al To	Novità New
KAWASAKI	1000	NINJA ZX-10	1988	1990	N
SUZUKI	400	GSF 400 M N P BANDIT	1991	1993	N
SUZUKI	600	GSF 600 BANDIT	1999	2003	N
SUZUKI	600	GSF BANDIT 600	1996	2005	N
SUZUKI	600	GSX 600 FJ KATANA	1989	1991	N
SUZUKI	600	GSX 600 F KATANA	1992	2004	N
SUZUKI	600	GSX 600 FK / FL / FM KATANA	1989	1991	N
SUZUKI	600	GSXF 600	1998	2004	N
SUZUKI	600	GSXF 600 FJ FK FL FM KATANA	1988	2006	N
SUZUKI	650	SV 650 A L7-L8	2017	2018	N
SUZUKI	650	GSF BANDIT ET BANDIT S 650	2006	2015	N
SUZUKI	650	GSXF 650	1998	2004	N
SUZUKI	650	SV 650	1999	2010	
SUZUKI	750	GSX 750 F KATANA	1992	2004	N
SUZUKI	750	GSX 750 FK / FL / FM KATANA	1989	1991	N
SUZUKI	750	GSXF 750 KATANA	1988	2006	N
SUZUKI	800	VL-800 K1-K4 INTRUDER VOLUSIA	2001	2004	N
SUZUKI	800	VX 800	1990	1993	N
SUZUKI	800	VZ 800 MARAUDER	1997	2004	N
SUZUKI	1100	GS 1100	1982	1984	N
SUZUKI	1100	GSX-1100 FJ KATANA	1988	1988	N
SUZUKI	1200	GV-1200 MADURA	1985	1986	N
SUZUKI	1400	GV-1400	1985	1989	N
SUZUKI	1400	VS 1400 GLP INTRUDER	1992	2004	N
SUZUKI	1400	VS-1400 GLP H / J	1987	1988	N
SUZUKI	1400	VS-1400 GLP INTRUDER	1992	2004	N
SUZUKI	1400	VS-1400 GLP L / M	1990	1991	N
YAMAHA	250	TZR 250	1988	1995	N
YAMAHA	600	FAZER 600	1998	2001	N
YAMAHA	600	YZF 600 THUNDERCAT	1996	2003	N
YAMAHA	600	FZR 600 R	1996	2002	N
YAMAHA	650	XVS-650	1998	2003	N
YAMAHA	650	XVS-650 S	2004	2004	N
YAMAHA	750	FZR 750	1987	1988	N
YAMAHA	750	FZR-750 RT / RU	1987	1988	N
YAMAHA	750	YZF-750	1996	1998	N
YAMAHA	850	TDM-850	1992	1993	N
YAMAHA	900	DIVERSION 900	1996	2001	N
YAMAHA	1000	FZR-1000	1987	1988	N
YAMAHA	1000	FZR-1000	1991	1993	N
YAMAHA	1000	YZF-1000 RK	1998	1998	N
YAMAHA	1100	FJ-1100 L / LC / N / NC	1984	1985	N
YAMAHA	1100	XVS-1100	2000	2003	N
YAMAHA	1200	V-MAX 1200	1988	1992	N
YAMAHA	1200	FJ-1200	1987	1990	N
YAMAHA	1200	FJ-1200	1992	1993	N

BRAKE/CLUTCH
MASTER CYLINDERS

ACCESSORIES
SPARE PARTS

CNC-WORKED FLUID
RESERVOIR

FULL CLUTCH

HYDRAULIC-CLUTCH
TRANFORMATION KIT

LEVER

THROTTLE CONTROL

BRAKE CALIPER

RACING KIT

BUTTON PANEL

LEVER GUARD

CLIP-ON

STREET RACING
REARSET

FUEL CAPS

STEERING NUT

CRASH PADS

PADDOCK STAND

MIRROR COVERS

REAR-VIEW MIRRORS

FOG LIGHTS KIT

HANDLEBARS
ACCESSORIES

HANDLEBARS

TUBI SEMI-MANUBRI

CLIP-ON RODS



Codice Reference	Descrizione Description	Misure Dimension	Ricambio per Spare part for
TB001	Tubi semi-manubri in alluminio realizzati in lega aeronautica 2014, no tappi tubi <i>Aluminium-made clip-on in 2014 aeronautic alloy no rod caps</i>	Lunghezza / Length: 280 mm Ø Interno / Inner Ø: 17 mm	CP003 + CP004
TB002	Tubi semi-manubri in alluminio realizzati in lega 7003 <i>Aluminium-made clip-on in 7003 alloy</i>	Lunghezza / Length: 250 mm Ø Interno / Inner Ø: 17 mm	CP003 + CP004
TB003	Tubi semi-manubri in alluminio realizzati in lega 7003 <i>Aluminium-made clip-on in 7003 alloy</i>	Lunghezza / Length: 280 mm Ø Interno / Inner Ø: 17 mm	CP001 + CP002
TB004	Tubi semi-manubri in alluminio realizzati in lega 7003 <i>Aluminium-made clip-on in 7003 alloy</i>	Lunghezza / Length: 280 mm Ø Interno / Inner Ø: 17 mm	CP007

Ricambi / Spare parts

Codice Reference	Descrizione Description	Misure Dimension	Colore tappi Cap colour
TT001	Tappi tubo semi-manubrio <i>Cap for clip-on rod</i>	Ø Interno / Inner Ø: 17 mm	N ● nero - black

Colori tubi / Colours clip-on

N ●
nero - black

O ●
arancione
orange

Y ●
oro - gold

B ●
blu - blue

R ●
rosso - red

S ●
argento - silver

G ●
verde - green

BRAKE/CLUTCH
MASTER CYLINDERS
 ACCESSORIES
SPARE PARTS
 CNC-WORKED FLUID
RESERVOIR
 FULL CLUTCH
 HYDRAULIC-CLUTCH
TRANSFORMATION KIT
 LEVER
 THROTTLE CONTROL
 BRAKE CALIPER
 RACING KIT
 BUTTON PANEL
 LEVER GUARD
 CLIP-ON
 STREET RACING
REARSET
 FUEL CAPS
 STEERING NUT
 CRASH PADS
 PADDOCK STAND
 MIRROR COVERS
 REAR-VIEW MIRRORS
 FOG LIGHTS KIT
 HANDLEBARS
ACCESSORIES
 HANDLEBARS

MANOPOLE RACING ALLUMINIO CNC

ALUMINIUM CNC-WORKED RACING GRIPS



Codice Reference	Descrizione Description	Note Note
GR004	Manopole racing in alluminio CNC Aluminium CNC-Worked racing grips	Vendute a coppie / Sold in pairs

Colori / Colours

N  nero - black

Y  oro - gold

B  blu - blue

R  rosso - red

S  argento - silver

G  verde - green

BRAKE/CLUTCH
MASTER CYLINDERS

ACCESSORIES
SPARE PARTS

CNC-WORKED FLUID
RESERVOIR

FULL CLUTCH

HYDRAULIC-CLUTCH
TRANSFORMATION KIT

LEVER

THROTTLE CONTROL

BRAKE CALIPER

RACING KIT

BUTTON PANEL

LEVER GUARD

CLIP-ON

STREET RACING
REARSET

FUEL CAPS

STEERING NUT

CRASH PADS

Paddock STAND

MIRROR COVERS

REAR-VIEW MIRRORS

FOG LIGHTS KIT

HANDLEBARS
ACCESSORIES

HANDLEBARS

Applicazioni / Application list

Marca Brand	CC	Modello Model	Anno dal From	Anno al To	Novità New	Marca Brand	CC	Modello Model	Anno dal From	Anno al To	Novità New
APRILIA	250	RS 250	1998	2003	N	BENELLI	900	TRE-K 899	2009	2011	N
APRILIA	660	PEGASO STRADA(FUN)-FACTORY-TRAIL	2005	2009	N	BENELLI	1130	TNT	2006	2006	N
APRILIA	750	DORSODURO FACTORY	2010	2013		BENELLI	1130	TNT - TNT SPORT	2004	2005	N
APRILIA	750	DORSODURO 750	2008	2016	N	BENELLI	1130	TNT CAFE' RACER	2006	2014	N
APRILIA	750	SHIVER GT	2009	2009		BENELLI	1130	TNT CENTURY RACER	2011	2014	N
APRILIA	750	SHIVER 750	2010	2016	N	BENELLI	1130	TNT R	2011	2014	N
APRILIA	850	MANA GT	2009	2016		BENELLI	1130	TNT R160	2010	2014	N
APRILIA	850	MANA	2007	2011	N	BENELLI	1130	TNT SPORT	2006	2006	N
APRILIA	900	SHIVER EURO 4 ABS NAVI	2019	2019	N	BENELLI	1130	TNT SPORT EVO	2007	2007	N
APRILIA	900	SHIVER 900	2017	2018	N	BENELLI	1130	TNT TITANIUM	2005	2007	
APRILIA	900	DORSODURO EURO 4 ABS	2018	2018	N	BENELLI	1130	TORNADO 1130 TRE	2007	2007	
APRILIA	900	DORSODURO	2017	2017	N	BENELLI	1130	TRE-K	2007	2012	N
APRILIA	1000	RSV4 FACTORY / SBK RACING	2009	2014		BENELLI	1130	TRE-K AMAZONAS	2007	2012	N
APRILIA	1000	RSV4 FACTORY APRC ABS	2013	2014	N	BENELLI	1130	TRE-K BIANCO/ROSSO	2008	2008	N
APRILIA	1000	SL 1000 FALCO	2000	2003		BIMOTA	1078	DELIRIO	2006	2015	
APRILIA	1000	RSV 1000 R - FACTORY - DREAM	2004	2008		BIMOTA	1100	DB5R EVO	2011	2013	
APRILIA	1000	RSV4 R	2009	2014		BIMOTA	1100	DB7 / DB7 ORONERO	2008	2009	
APRILIA	1000	RSV 1000 R TUONO	2002	2005		BIMOTA	1100	DB7	2008	2008	N
APRILIA	1000	RSV, RSV R	2003	2003		BIMOTA	1200	DB8 - DB8 SP	2011	2013	
APRILIA	1000	RSV, RSV R	2000	2002	N	BIMOTA	1200	DB9 BRIVIDO - DB9 BRIVIDO S	2012	2013	
APRILIA	1000	RST FUTURA	2001	2003	N	BMW	800	F800 GS / ADVENTURE	2008	2015	N
APRILIA	1000	ETV CAPO NORD ABS	2004	2007	N	BMW	800	F800 R	2009	2015	N
APRILIA	1000	ETV CAPO NORD - RALLY	2001	2003	N	BMW	1000	S1000 R	2014	2018	N
APRILIA	1000	RSV V2 1000	2004	2008	N	BMW	1000	S1000 RR	2009	2018	N
APRILIA	1000	RSV4 RACING FACTORY LE	2015	2018	N	BMW	1200	K 1200 R	2005	2008	
APRILIA	1000	RSV4 RR	2015	2018	N	BMW	1200	R 1200 GS	2004	2013	
APRILIA	1000	RSV4 RR RACER PACK	2015	2015	N	BMW	1200	R 1200 R	2006	2009	
APRILIA	1000	TUONO V2 1000	2002	2009	N	BMW	1200	R 1200 S	2006	2009	
APRILIA	1000	TUONO V4 R STD - APRC	2011	2014	N	BMW	1200	R1200 GS ADVENTURE	2006	2013	N
APRILIA	1000	RSV4 FACTORY APRC STD - SE	2011	2012	N	CAGIVA	650	RAPTOR / V RAPTOR / RAPTOR IE	2001	2006	
APRILIA	1000	RSV4 APRC R	2011	2012	N	CAGIVA	1000	RAPTOR / V RAPTOR / X-TRA RAPTOR	2000	2005	
APRILIA	1000	RSV4 APRC R ABS	2013	2014	N	CAGIVA	1000	NAVIGATOR	2000	2005	N
APRILIA	1000	TUONO 1000 R FACTORY	2006	2009	N	DUCATI	400	MONSTER 400	2004	2008	N
APRILIA	1000	RSV 1000	1998	1999	N	DUCATI	400	MONSTER 400 DARK	2005	2005	N
APRILIA	1000	RSV 1000 SP	1999	2000	N	DUCATI	400	SCRAMBLER HASHTAG	2018	2018	N
APRILIA	1100	TUONO V4 FACTORY	2015	2019		DUCATI	400	SCRAMBLER SIXTY2	2016	2020	N
APRILIA	1100	TUONO V4 RR	2015	2019	N	DUCATI	600	MONSTER 600	1994	2002	N
APRILIA	1200	CAPONORD 1200	2013	2016		DUCATI	620	MONSTER 620	2002	2002	N
APRILIA	1200	CAPONORD RALLY	2015	2016	N	DUCATI	620	MONSTER 620 DARK	2005	2006	N
APRILIA	1200	DORSODURO 1200	2010	2016	N	DUCATI	620	MONSTER 620 DARK SINGLE DISC	2005	2005	N
BENELLI	300	BN302	2015	2016	N	DUCATI	620	MULTISTRADA 620	2006	2006	N
BENELLI	300	BN302 ABS EURO 4	2017	2017	N	DUCATI	620	MULTISTRADA 620 DARK	2006	2006	N
BENELLI	302	302R ABS EURO 4	2017	2017	N	DUCATI	620	SUPERSPORT 620 S	2003	2003	N
BENELLI	500	LEONCINO 500 / TRAIL	2017	2018	N	DUCATI	695	MONSTER 695	2007	2012	N
BENELLI	600	BN600	2014	2016	N	DUCATI	696	MONSTER 696 ABS	2011	2014	
BENELLI	600	BN600 GT	2015	2016	N	DUCATI	696	MONSTER 696 ABS ANNIVERSARY	2013	2013	N
BENELLI	600	BN600 GT EU3 ABS	2016	2016	N	DUCATI	696	MONSTER 696 ANNIVERSARY	2013	2013	N
BENELLI	600	BN600 R	2014	2014	N	DUCATI	748	748	1995	2006	
BENELLI	900	899 CAFE' RACER	2010	2010	N	DUCATI	748	748 E	2001	2002	N
BENELLI	900	TNT 899	2012	2014	N	DUCATI	748	748 R	1999	1999	N
BENELLI	900	TNT 899	2008	2009	N	DUCATI	748	748 R SINGLE-SEAT	1998	2002	N
BENELLI	900	TNT 899 CENTURY RACER	2011	2014	N	DUCATI	748	748 RS	2000	2001	N
BENELLI	900	TNT 899S	2008	2009	N	DUCATI	748	748 S	2000	2002	N
BENELLI	900	TORNADO 900 TRE	2003	2003	N	DUCATI	748	748 SPS	1998	1999	N
BENELLI	900	TORNADO LE	2002	2003	N	DUCATI	749	749	2003	2007	
BENELLI	900	TORNADO RS	2004	2005	N	DUCATI	750	MONSTER 750	2002	2002	N

- BRAKE/CLUTCH MASTER CYLINDERS
- ACCESSORIES SPARE PARTS
- CNC-WORKED FLUID RESERVOIR
- FULL CLUTCH
- HYDRAULIC-CLUTCH TRANSFORMATION KIT
- LEVER
- THROTTLE CONTROL
- BRAKE CALIPER
- RACING KIT
- BUTTON PANEL
- LEVER GUARD
- CLIP-ON
- STREET RACING REARSET
- FUEL CAPS
- STEERING NUT
- CRASH PADS
- PADOCK STAND
- MIRROR COVERS
- REAR-VIEW MIRRORS
- FOG LIGHTS KIT
- HANDLEBARS ACCESSORIES
- HANDLEBARS

Marca Brand	CC	Modello Model	Anno dal From	Anno al To	Novità New	Marca Brand	CC	Modello Model	Anno dal From	Anno al To	Novità New
DUCATI	750	SUPERSPORT 750 SS	1999	2002	N	DUCATI	998	998 FINAL ED. SINGLE	2004	2004	N
DUCATI	795	MONSTER 795 ABS CORSE STRIPE	2014	2015	N	DUCATI	998	998 MATRIX	2004	2004	N
DUCATI	795	MONSTER 795 ABS RED STRIPE C	2015	2015	N	DUCATI	998	998 MATRIX SINGLE-SEAT	2004	2004	N
DUCATI	796	MONSTER 796 ABS	2011	2014	N	DUCATI	998	998 R	2002	2002	N
DUCATI	796	MONSTER 796 ABS ANNIVERSARY	2013	2013	N	DUCATI	998	998 RS	2002	2003	N
DUCATI	796	MONSTER 796 ANNIVERSARY	2013	2013	N	DUCATI	998	998 S BAYLISS	2002	2002	N
DUCATI	797	MONSTER 797	2017	2019	N	DUCATI	998	998 S BOSTROM	2002	2002	N
DUCATI	800	HYPERMOTARD 796	2010	2012	N	DUCATI	998	999 R	2003	2006	N
DUCATI	800	MONSTER 796	2011	2013	N	DUCATI	998	999 R XEROX 998	2006	2006	N
DUCATI	800	MONSTER 797	2017	2019	N	DUCATI	998	999 S	2003	2006	N
DUCATI	800	MONSTER 797 PLUS	2017	2019	N	DUCATI	998	999 S AMA REPLICA	2007	2007	N
DUCATI	800	MONSTER 800	2003	2005	N	DUCATI	999	999 / R / S	2002	2006	N
DUCATI	800	MONSTER S2R 800	2005	2007	N	DUCATI	1000	MONSTER 1000	2003	2005	N
DUCATI	800	MONSTER S2R 800 DARK	2005	2006	N	DUCATI	1000	MONSTER 1000 S	2005	2005	N
DUCATI	800	SCRAMBLER CAFE RACER	2017	2018	N	DUCATI	1000	MONSTER S2 R 1000	2006	2008	N
DUCATI	800	SCRAMBLER CLASSIC	2015	2018	N	DUCATI	1000	MONSTER S4 RS	2006	2006	N
DUCATI	800	SCRAMBLER DESERT SLED	2017	2018	N	DUCATI	1000	MULTISTRADA 1000	2003	2006	N
DUCATI	800	SCRAMBLER FULL THROTTLE	2015	2018	N	DUCATI	1000	SPORT TOURING ST3	2004	2006	N
DUCATI	800	SCRAMBLER ICON	2015	2018	N	DUCATI	1000	SPORT TOURING ST3 S ABS	2006	2006	N
DUCATI	800	SCRAMBLER ITALIA INDEPENDENT / U	2016	2016	N	DUCATI	1000	SPORTCLASSIC GT1000	2007	2010	N
DUCATI	800	SCRAMBLER MACH 2.0	2018	2018	N	DUCATI	1000	SPORTCLASSIC GT1000	2010	2010	N
DUCATI	800	SCRAMBLER STREET CLASSIC	2018	2018	N	DUCATI	1000	SPORTCLASSIC GT1000 TOURING	2009	2009	N
DUCATI	800	SCRAMBLER URBAN ENDURO	2015	2016	N	DUCATI	1000	SPORTCLASSIC PAUL SMART	2006	2006	N
DUCATI	800	SUPERSPORT 800 SS	2003	2005	N	DUCATI	1000	SPORTCLASSIC SPORT 1000	2007	2008	N
DUCATI	848	STREETFIGHTER 848	2011	2015	N	DUCATI	1000	SPORTCLASSIC SPORT 1000 BIPOSTO	2007	2008	N
DUCATI	848	848	2008	2010	N	DUCATI	1000	SPORTCLASSIC SPORT 1000 S	2007	2009	N
DUCATI	848	848 EVO	2011	2013	N	DUCATI	1000	SPORTCLASSIC SPORT 1000 SINGLE-SEAT	2006	2007	N
DUCATI	848	848 EVO CORSE	2012	2013	N	DUCATI	1000	SUPERSPORT 1000 SS	2003	2006	N
DUCATI	848	848 HAYDEN	2010	2010	N	DUCATI	1098	STREETFIGHTER 1098	2009	2014	N
DUCATI	900	MONSTER 900	2000	2002	N	DUCATI	1098	STREETFIGHTER 1098 S	2009	2014	N
DUCATI	900	SPORTCLASSIC MH900E	2001	2002	N	DUCATI	1098	1098	2007	2008	N
DUCATI	900	SUPERSPORT 900 SS	1998	2002	N	DUCATI	1098	1098 R	2008	2009	N
DUCATI	916	MONSTER S4	2001	2002	N	DUCATI	1098	1098 S	2007	2008	N
DUCATI	916	MONSTER S4 FOGARTY	2002	2002	N	DUCATI	1100	HYPERMOTARD 1100	2007	2009	N
DUCATI	916	SPORT TOURING ST4	1999	2003	N	DUCATI	1100	HYPERMOTARD 1100 EVO	2010	2012	N
DUCATI	916	916	1994	1997	N	DUCATI	1100	HYPERMOTARD 1100 EVO SP	2010	2012	N
DUCATI	916	916 SENNA	1994	1998	N	DUCATI	1100	HYPERMOTARD 1100 S	2007	2009	N
DUCATI	916	916 SP	1995	1996	N	DUCATI	1100	MONSTER 1100	2009	2010	N
DUCATI	939	HYPERMOTARD HYPERSTRADA 939	2016	2016	N	DUCATI	1100	MONSTER 1100 ABS	2010	2010	N
DUCATI	944	SPORT TOURING ST2	1997	2003	N	DUCATI	1100	MONSTER 1100 DIESEL	2013	2013	N
DUCATI	989	DESMOSEDICI RR	2008	2008	N	DUCATI	1100	MONSTER 1100 EVO ABS	2012	2013	N
DUCATI	996	MONSTER S4R	2003	2006	N	DUCATI	1100	MONSTER 1100 EVO ANNIVERSARY	2013	2013	N
DUCATI	996	SPORT TOURING ST4 S	2001	2005	N	DUCATI	1100	MONSTER 1100 S	2009	2010	N
DUCATI	996	SPORT TOURING ST4 S ABS	2003	2005	N	DUCATI	1100	MONSTER 1100 S ABS	2010	2010	N
DUCATI	996	916 R	1997	1998	N	DUCATI	1100	STREETFIGHTER S 1100	2010	2012	N
DUCATI	996	916 SPS	1997	1998	N	DUCATI	1100	STREETFIGHTER 1100	2010	2011	N
DUCATI	996	996	1999	2001	N	DUCATI	1198	1198	2009	2011	N
DUCATI	996	996 R	1999	2001	N	DUCATI	1198	1198 S	2009	2010	N
DUCATI	996	996 R II	2001	2001	N	DUCATI	1198	1198 S CORSE	2010	2010	N
DUCATI	996	996 RS	2000	2001	N	DUCATI	1198	1198 SP	2011	2011	N
DUCATI	996	996 S	2001	2001	N	DUCATI	1198	1198 R 1200	2010	2010	N
DUCATI	996	996 SPS	1999	2000	N	DUCATI	1200	DIAVEL 1200	2011	2018	N
DUCATI	996	996 SPS II	1999	1999	N	DUCATI	1200	MULTISTRADA 1200	2010	2012	N
DUCATI	996	996 SPS III	2000	2000	N	DUCATI	1200	MULTISTRADA 1200 ABS	2010	2014	N
DUCATI	998	998	2002	2003	N	DUCATI	1200	MULTISTRADA 1200 S ABS	2010	2010	N
DUCATI	998	998 FINAL ED.	2004	2004	N	DUCATI	1200	MULTISTRADA 1200 S GT	2013	2014	N

BRAKE/CLUTCH
MASTER CYLINDERS
 ACCESSORIES
SPARE PARTS
 CNC-WORKED FLUID
RESERVOIR
 FULL CLUTCH
 HYDRAULIC-CLUTCH
TRANFORMATION KIT
 LEVER
 THROTTLE CONTROL
 BRAKE CALIPER
 RACING KIT
 BUTTON PANEL
 LEVER GUARD
 CLIP-ON
 STREET RACING
REARSET
 FUEL CAPS
 STEERING NUT
 CRASH PADS
 PADDOCK STAND
 MIRROR COVERS
 REAR-VIEW MIRRORS
 FOG LIGHTS KIT
 HANDLEBARS
ACCESSORIES
 HANDLEBARS

Marca Brand	CC	Modello Model	Anno dal From	Anno al To	Novità New	Marca Brand	CC	Modello Model	Anno dal From	Anno al To	Novità New
DUCATI	1200	MULTISTRADA 1200 S SPORT	2011	2012	N	KAWASAKI	900	Z900	2018	2019	N
DUCATI	1200	MULTISTRADA 1200 S TOURING	2013	2014	N	KAWASAKI	900	Z900 A2	2018	2019	N
DUCATI	1260	MULTISTRADA 1260 ENDURO	2019	2019	N	KAWASAKI	1000	KLZ 1000 VERSYS	2015	2018	N
GILERA	125	NEXUS EURO3 125	2007	2008	N	KAWASAKI	1000	Z1000 ABS	2007	2009	N
GILERA	125	NEXUS EURO3 IE 125	2008	2010	N	KAWASAKI	1000	NINJA H2 SX	2018	2019	N
GILERA	250	NEXUS EURO3	2006	2007	N	KAWASAKI	1000	Z1000	2003	2013	N
GILERA	300	NEXUS EURO3 300	2008	2011	N	KAWASAKI	1000	NINJA ZX-10 R	2004	2017	N
GILERA	500	NEXUS 500	2003	2005	N	KAWASAKI	1000	KLZ VERSYS 1000	2017	2018	N
GILERA	500	NEXUS 500	2003	2005	N	KAWASAKI	1000	Z 1000 SX ABS	2011	2013	N
GILERA	500	NEXUS 500 SP EURO3	2006	2007	N	KAWASAKI	1100	ZRX 1100	1997	1999	N
GILERA	500	NEXUS EURO3 500	2006	2011	N	KAWASAKI	1200	ZRX 1200 S	2001	2004	N
GILERA	500	NEXUS SP EURO3 500	2006	2007	N	KAWASAKI	1200	ZRX 1200 R	2001	2006	N
GILERA	800	GP 800	2007	2011	N	KAWASAKI	1200	ZRX 1200	2001	2004	N
GILERA	800	GP 800 CENTENARIO	2009	2009	N	KAWASAKI	1400	ZZR 1400 ABS	2006	2020	N
HONDA	600	HORNET 600	2007	2013	N	KAWASAKI	1400	GTR 1400	2008	2009	N
HONDA	600	CBR 600 F	2007	2013	N	KAWASAKI	1400	ZZR 1400	2006	2007	N
HONDA	600	CBR 600 RR	2007	2014	N	KTM	125	DUKE 125	2013	2018	N
HONDA	700	NC700X ABS	2012	2013	N	KTM	125	RC 125	2013	2018	N
HONDA	750	INTEGRA	2012	2013	N	KTM	390	DUKE 390	2012	2018	N
HONDA	1000	CB 1000 R	2008	2015	N	KTM	390	RC 390 R	2018	2018	N
HONDA	1000	CBR 1000 RR FIREBLADE	2006	2014	N	KTM	390	RC 390	2017	2018	N
HUSQVARNA	900	NUDA - NUDA R ABS	2012	2013	N	KTM	690	DUKE 690 R	2014	2017	N
KAWASAKI	250	NINJA 250 R	2008	2012	N	KTM	690	DUKE 690	2014	2016	N
KAWASAKI	300	Z300	2015	2016	N	KTM	690	ENDURO 690 R	2014	2017	N
KAWASAKI	300	Z300 ABS	2017	2018	N	KTM	950	SUPERMOTO 950	2005	2008	N
KAWASAKI	300	NINJA 300	2013	2016	N	KTM	990	DUKE 990 SD	2005	2011	N
KAWASAKI	300	KLE 300 VERSYS-X	2017	2020	N	KTM	990	SUPERMOTO 990 SMR/SMT	2009	2012	N
KAWASAKI	400	Z400	2019	2019	N	KTM	1050	ADVENTURE 1050	2015	2016	N
KAWASAKI	400	NINJA 400	2018	2020	N	KTM	1090	ADVENTURE 1090 R	2017	2019	N
KAWASAKI	500	ER-5	1997	2005	N	KTM	1090	ADVENTURE 1090	2017	2019	N
KAWASAKI	600	NINJA ZX-6 R	2003	2014	N	KTM	1190	RC8 R 1190	2009	2015	N
KAWASAKI	600	NINJA ZX-6 RR	2003	2005	N	KTM	1190	ADVENTURE 1190 R	2013	2016	N
KAWASAKI	636	NINJA ZX-6 R	2003	2006	N	KTM	1190	ADVENTURE 1190	2013	2016	N
KAWASAKI	650	ER-6 F	2012	2016	N	KTM	1290	ADVENTURE 1290 SUPER ADV	2015	2016	N
KAWASAKI	650	Z650 ABS	2017	2019	N	KTM	1290	DUKE 1290 R SD	2014	2016	N
KAWASAKI	650	VULCAN 650 S	2015	2020	N	MV AGUSTA	750	BRUTALE 4 CILINDRI 750 S	2003	2008	N
KAWASAKI	650	NINJA 650	2017	2019	N	MV AGUSTA	750	F4 1000	2000	2006	N
KAWASAKI	650	KLE 650 VERSYS	2011	2020	N	MV AGUSTA	750	F4 750	2000	2006	N
KAWASAKI	650	ER-6F ABS	2012	2016	N	MV AGUSTA	800	DRAGSTER 800 RC	2017	2018	N
KAWASAKI	650	ER-6N ABS	2012	2016	N	MV AGUSTA	910	BRUTALE 4 CILINDRI 910 R	2005	2011	N
KAWASAKI	650	ER-6 N	2012	2016	N	MV AGUSTA	910	BRUTALE 4 CILINDRI 910 S	2003	2011	N
KAWASAKI	650	KLE VERSYS 650 ABS	2007	2014	N	MV AGUSTA	920	BRUTALE 4 CILINDRI 920	2011	2012	N
KAWASAKI	650	ER-6 N	2006	2011	N	MV AGUSTA	989	BRUTALE 4 CILINDRI 989 R	2005	2008	N
KAWASAKI	650	ER-6 N ABS	2006	2011	N	MV AGUSTA	990	BRUTALE 4 CILINDRI 990 R	2009	2012	N
KAWASAKI	650	ER-6 F	2006	2011	N	MV AGUSTA	1000	F4 1000	2010	2017	N
KAWASAKI	650	ER-6F ABS	2006	2011	N	MV AGUSTA	1000	F4 1000 312 R	2007	2008	N
KAWASAKI	650	KLE VERSYS 650	2007	2014	N	MV AGUSTA	1000	F4 1000 R	2010	2017	N
KAWASAKI	750	Z750 ABS	2007	2012	N	MV AGUSTA	1000	F4 1000 RC	2015	2018	N
KAWASAKI	750	Z750	2004	2014	N	MV AGUSTA	1000	F4 1000 RR	2010	2017	N
KAWASAKI	750	ZR-7 S	2001	2003	N	MV AGUSTA	1078	BRUTALE 4 CILINDRI 1078 RR	2007	2011	N
KAWASAKI	750	ZR-7	1999	2003	N	MV AGUSTA	1078	F4 1078 312 RR	2007	2008	N
KAWASAKI	750	Z750 S	2005	2006	N	MV AGUSTA	1090	BRUTALE 4 CILINDRI 1090	2013	2017	N
KAWASAKI	800	Z800 / E / ABS	2013	2016	N	MV AGUSTA	1090	BRUTALE 4 CILINDRI 1090 CORSA	2013	2016	N
KAWASAKI	900	Z900 ABS	2017	2017	N	MV AGUSTA	1090	BRUTALE 4 CILINDRI 1090 R	2012	2015	N
KAWASAKI	900	Z900 RS	2018	2020	N	MV AGUSTA	1090	BRUTALE 4 CILINDRI 1090 RR	2010	2017	N
KAWASAKI	900	Z900RS CAFE	2018	2020	N	SUZUKI	125	UX SIXTEEN 125	2008	2011	N

- BRAKE/CLUTCH MASTER CYLINDERS
- ACCESSORIES SPARE PARTS
- CNC-WORKED FLUID RESERVOIR
- FULL CLUTCH
- HYDRAULIC-CLUTCH TRANFORMATION KIT
- LEVER
- THROTTLE CONTROL
- BRAKE CALIPER
- RACING KIT
- BUTTON PANEL
- LEVER GUARD
- CLIP-ON
- STREET RACING REARSET
- FUEL CAPS
- STEERING NUT
- CRASH PADS
- PADDOCK STAND
- MIRROR COVERS
- REAR-VIEW MIRRORS
- FOG LIGHTS KIT
- HANDLEBARS ACCESSORIES
- HANDLEBARS

Marca Brand	CC	Modello Model	Anno dal From	Anno al To	Novità New	Marca Brand	CC	Modello Model	Anno dal From	Anno al To	Novità New
SUZUKI	125	UH125 BURGMAN	2007	2013	N	YAMAHA	600	FZ6 NS	2005	2006	N
SUZUKI	150	UX SIXTEEN 150	2008	2011	N	YAMAHA	600	FZ6 FAZER S2 ABS	2008	2008	N
SUZUKI	200	UH200 BURGMAN	2007	2013	N	YAMAHA	600	FZ6 FAZER S2	2007	2008	N
SUZUKI	400	AN400 BURGMAN	2007	2016	N	YAMAHA	600	FZ6 FAZER ABS	2006	2007	N
SUZUKI	600	GSX-R600	2004	2015	N	YAMAHA	600	FZ6 FAZER	2004	2007	N
SUZUKI	600	GSR600 K	2006	2011	N	YAMAHA	600	FZ6	2004	2007	N
SUZUKI	650	SV650 XA	2018	2018	N	YAMAHA	600	YZF-R6	2006	2018	N
SUZUKI	650	SV650 A	2017	2018	N	YAMAHA	660	XT660ZA TENERE	2011	2015	N
SUZUKI	650	DL650 V-STROM	2017	2011	N	YAMAHA	660	XT660Z TENERE	2008	2015	N
SUZUKI	650	GSF 650 BANDIT	2005	2008	N	YAMAHA	660	XT660 X	2004	2014	N
SUZUKI	650	GSX 650 F	2008	2012	N	YAMAHA	660	XT660 R	2004	2014	N
SUZUKI	750	GSX-R750	2004	2011	N	YAMAHA	660	MT-03	2006	2012	N
SUZUKI	750	GSR 750	2010	2014	N	YAMAHA	700	MT-07	2014	2018	N
SUZUKI	1000	GSX-R1000	2005	2014	N	YAMAHA	800	FZ8 N / NA / S / SA	2011	2015	N
SUZUKI	1200	GSF 1200 BANDIT	2006	2006	N	YAMAHA	850	XSR 900	2016	2019	N
SUZUKI	1250	GSX1250 FA	2010	2016	N	YAMAHA	850	MT-09 A ABS	2014	2016	N
SUZUKI	1250	GSF1250 SA	2015	2016	N	YAMAHA	850	MT-09 SP (MTN850 D)	2018	2018	N
SUZUKI	1250	GSF1250 S	2011	2012	N	YAMAHA	850	MT-09	2014	2019	N
SUZUKI	1250	GSF1250 BANDIT	2007	2010	N	YAMAHA	1000	FZ1	2006	2014	N
TRIUMPH	675	DAYTONA R 675 ABS	2009	2016	N	YAMAHA	1000	FZ1-NA	2010	2011	N
TRIUMPH	675	DAYTONA R 675	2010	2012	N	YAMAHA	1000	FZ1-N	2011	2011	N
TRIUMPH	675	STREET TRIPLE R	2009	2012	N	YAMAHA	1000	YZF-R1 SP	2006	2006	N
TRIUMPH	675	STREET TRIPLE R ABS	2012	2014	N	YAMAHA	1000	MT-10 D	2017	2017	N
TRIUMPH	675	STREET TRIPLE	2007	2013	N	YAMAHA	1000	MT-10	2016	2019	N
TRIUMPH	1050	SPEED TRIPLE 1050	2005	2015	N	YAMAHA	1000	FZS FAZER	2001	2005	N
YAMAHA	125	YP125RA X-MAX ABS	2013	2013	N	YAMAHA	1000	FZ1 FAZER	2006	2012	N
YAMAHA	125	YP125R X-MAX ABS	2011	2011	N	YAMAHA	1000	FZ1 FAZER ABS	2007	2012	N
YAMAHA	125	YP125R X-MAX	2006	2013	N	YAMAHA	1000	YZF-R1	1998	2016	N
YAMAHA	125	VP X-CITY	2008	2011	N	YAMAHA	1300	XJR1300	2002	2013	N
YAMAHA	250	YP250RA X-MAX ABS	2011	2013	N	YAMAHA	1300	XJR1300 C	2015	2016	N
YAMAHA	250	YP250R X-MAX SPORT	2011	2012	N	YAMAHA	1300	XJR1300 - XJR1300 SP	1999	2001	N
YAMAHA	250	YP250R X-MAX	2005	2013	N	YAMAHA	1700	MT-01 S	2009	2009	N
YAMAHA	250	YP250R BLACK X-MAX	2009	2009	N	YAMAHA	1700	MT-01	2005	2009	N
YAMAHA	250	YP250 MAJESTY DX	1998	1999	N	YAMAHA	1700	V-MAX	2009	2016	N
YAMAHA	250	YP250 MAJESTY ABS	2003	2003	N						
YAMAHA	250	YP250 MAJESTY	2000	2003	N						
YAMAHA	250	VP X-CITY	2007	2015	N						
YAMAHA	250	YZF R25	2014	2015	N						
YAMAHA	320	YZF R3	2015	2018	N						
YAMAHA	400	YP400 MAJESTY ABS	2007	2011	N						
YAMAHA	400	YP400 MAJESTY	2004	2011	N						
YAMAHA	500	XP T-MAX WHITE MAX ABS	2010	2010	N						
YAMAHA	500	XP T-MAX WHITE MAX	2010	2010	N						
YAMAHA	500	XP T-MAX SV / ABS	2011	2011	N						
YAMAHA	500	XP T-MAX ABS SV	2010	2011	N						
YAMAHA	530	XP T-MAX	2008	2016	N						
YAMAHA	530	XP T-MAX SP / ABS	2015	2016	N						
YAMAHA	530	XP T-MAX ABS	2015	2016	N						
YAMAHA	600	XJ6-S DIVERSION ABS	2013	2015	N						
YAMAHA	600	XJ6-S DIVERSION	2003	2015	N						
YAMAHA	600	XJ6-NA ABS	2011	2015	N						
YAMAHA	600	XJ6-N SP	2013	2013	N						
YAMAHA	600	XJ6-N	2009	2014	N						
YAMAHA	600	XJ6-FA DIVERSION ABS	2010	2011	N						
YAMAHA	600	XJ6-F DIVERSION	2010	2011	N						
YAMAHA	600	FZS FAZER	1998	2003	N						
YAMAHA	600	FZ6 S2	2007	2008	N						

BRAKE/CLUTCH
 MASTER CYLINDERS
 ACCESSORIES
 SPARE PARTS
 CNC-WORKED FLUID
 RESERVOIR
 FULL CLUTCH
 HYDRAULIC-CLUTCH
 TRANFORMATION KIT
 LEVER
 THROTTLE CONTROL
 BRAKE CALIPER
 RACING KIT
 BUTTON PANEL
 LEVER GUARD
 CLIP-ON
 STREET RACING
 REARSET
 FUEL CAPS
 STEERING NUT
 CRASH PADS
 PADDOCK STAND
 MIRROR COVERS
 REAR-VIEW MIRRORS
 FOG LIGHTS KIT
 HANDLEBARS
 ACCESSORIES
 HANDLEBARS

MANOPOLE RISCALDATE

WARMED-UP GRIPS



Codice Reference	Descrizione Description	Caratteristiche tecniche Technical details
GR005	Manopole riscaldate Warming-up grips	Lunghezza / Length: 123 mm Diametro / Ø: 22 mm Peso netto / Net weight: 221 gr Tensione d'alimentazione / Electric tension: 12V Potenza riscaldante / Rated heat: max 24 w

Colore / Color

N ●
nero - black

Spiegazione
Explanation

- Standard di qualità superiore
- Facili da installare
- Dispositivo di protezione anti-inversione di polarità integrato: in caso di collegamento errato, la centralina non subisce danni
- Regolazione di temperatura in 4 posizioni integrata alla manopola
- Centralina di regolazione separata: in caso di sostituzione, non occorre smontare le manopole
- Manopole in gomma con disegno anti-scivolo
- Guaina in calza trecciata per la protezione dei cablaggi elettrici

- High-quality standard
- Easy to assemble
- Anti-polarity inversion device integrated: in case of wrong connection, control unit won't undergo any damages
- 4-position heat adjuster integrated to grip
- Separated control unit: replaceable without grips dismantling
- Rubber-coated grips, with non-slip pattern
- Sheath in braided sock for the protection of electrical wiring

Manopole vendute a coppie / Grips sold in pairs

BRAKE/CLUTCH
MASTER CYLINDERS
ACCESSORIES
SPARE PARTS
CNC-WORKED FLUID
RESERVOIR
FULL CLUTCH
HYDRAULIC-CLUTCH
TRANSFORMATION KIT
LEVER
THROTTLE CONTROL
BRAKE CALIPER
RACING KIT
BUTTON PANEL
LEVER GUARD
CLIP-ON
STREET RACING
REARSET
FUEL CAPS
STEERING NUT
CRASH PADS
PADDOCK STAND
MIRROR COVERS
REAR-VIEW MIRRORS
FOG LIGHTS KIT
HANDLEBARS
ACCESSORIES
HANDLEBARS

PEDANE STREET RACING STREET RACING REARSETS



BRAKE/CLUTCH
MASTER CYLINDERS

ACCESSORIES
SPARE PARTS

CNC-WORKED FLUID
RESERVOIR

FULL CLUTCH

HYDRAULIC-CLUTCH
TRANFORMATION KIT

LEVER

THROTTLE CONTROL

BRAKE CALIPER

RACING KIT

BUTTON PANEL

LEVER GUARD

CLIP-ON

STREET RACING
REARSET

FUEL CAPS

STEERING NUT

CRASH PADS

Paddock STAND

MIRROR COVERS

REAR-VIEW MIRRORS

FOG LIGHTS KIT

HANDLEBARS
ACCESSORIES

HANDLEBARS

Applicazioni / Application list

Marca Brand	CC	Modello Model	Anno dal Form	Anno al To	Cambio / Shift		Codice Reference	Novità New	Colore Pedana Rearset colour	Colore inserti Insets colour
					Standard	Rovesciato/ Reversed				
APRILIA	1000	RSV4 RACING FACTORY LE	2015	2019	x		FT002	N		
APRILIA	1000	RSV4 RR	2015	2019	x		FT002	N		
APRILIA	1000	RSV4 RR RACER PACK	2015	2019	x		FT002	N		
APRILIA	1000	RSV4 APRC R ABS	2013	2014	x	x	FT095		N ●	R ●
APRILIA	1000	RSV4 FACTORY APRC ABS	2013	2014	x	x	FT095		nero - black	rosso - red
APRILIA	1000	RSV4 APRC R	2011	2012	x		FT002			
APRILIA	1000	RSV4 FACTORY APRC STD - SE	2011	2012	x		FT002			
APRILIA	1000	RSV4(R/FACTORY)	2009	2012	x		FT002			
BMW	999	S1000R	2017	2018	x	x	FT052	N		
BMW	999	S1000RR	2015	2018	x	x	FT052	N		
BMW	999	S1000R	2014	2016	x		FT003		N ●	B ●
BMW	999	S1000RR	2009	2014	x		FT003		nero - black	blu - blue
BMW	999	S1000RR (RACING)	2009	2014	x	x	FT094			
DUCATI	850	848 EVO	2011	2013	x	x	FT053			
DUCATI	850	848 EVO CORSE SE	2012	2013	x	x	FT053			
DUCATI	850	848 HAYDEN	2010	2010	x	x	FT053			
DUCATI	850	848	2008	2008	x	x	FT053			
DUCATI	899	899	2013	2015	x		FT097			
DUCATI	1100	1098	2007	2008	x	x	FT008			
DUCATI	1100	1098 S	2007	2008	x	x	FT008		N ●	R ●
DUCATI	1100	1098 S TRICOLORE	2007	2008	x	x	FT008		nero - black	rosso - red
DUCATI	1200	1199PANIGALE	2012	2012	x	x	FT007			
DUCATI	1200	1198	2009	2011	x	x	FT053			
DUCATI	1200	1198 SP	2011	2011	x	x	FT053			
DUCATI	1200	1198 S	2009	2010	x	x	FT053			
DUCATI	1200	1098 R	2009	2009	x	x	FT053			
DUCATI	1200	1098 R BAYLISS	2009	2009	x	x	FT053			
HONDA	125	MSX125	2013	2016	x		FT073			
HONDA	250	CBR250R	2011	2013	x		FT011			
HONDA	599	CBR600RR	2009	2013	x	x	FT108			
HONDA	599	CBR600RR	2007	2008		x	FT014		N ●	R ●
HONDA	600	CBR600RR	2004	2006	x		FT098		nero - black	rosso - red
HONDA	999	CBR1000RR	2008	2011	x	x	FT074			
HONDA	999	CBR1000RR	2004	2007		x	FT017			
HONDA	1000	CBR 1000 RR (NON ABS)	2012	2017	x		FT086	N		
KAWASAKI	125	Z125 PRO	2015	2017	x		FT104			
KAWASAKI	250	NINJA 250R	2008	2012	x	x	FT021			
KAWASAKI	300	NINJA 300R	2013	2015	x	x	FT075			
KAWASAKI	400	NINJA 400	2018	2020	x	x	FT114	N		
KAWASAKI	400	Z 400	2019	2020	x	x	FT114	N		
KAWASAKI	600	ZX-6R	2014	2016	x	x	FT076			
KAWASAKI	600	ZX-6R	2009	2013	x	x	FT076			
KAWASAKI	600	ZX-6R	2007	2008	x		FT077			
KAWASAKI	600	ZX-6R	2005	2006	x		FT099			
KAWASAKI	600	ZX-6RR	2005	2005	x		FT078			
KAWASAKI	636	636 ZX-6R	2013	2016	x	x	FT076		N ●	G ●
KAWASAKI	636	636 ZX-6R ABS	2013	2016	x	x	FT076		nero - black	verde - green
KAWASAKI	636	636 ZX-6R	2005	2006	x		FT078			
KAWASAKI	800	Z800	2013	2016	x		FT079			
KAWASAKI	800	Z800-ABS	2013	2016	x		FT079			
KAWASAKI	800	Z800-E	2013	2016	x		FT079			
KAWASAKI	800	Z800-E-ABS	2013	2016	x		FT079			
KAWASAKI	800	Z800-E-SPECIAL-EDITION	2016	2016	x		FT079			
KAWASAKI	1000	ZX-10R	2016	2019	x		FT105	N		
KAWASAKI	1000	Z1000	2014	2016	x		FT083			
KAWASAKI	1000	ZX-10R	2015	2015	x		FT084			
KAWASAKI	1000	ZX-10R	2011	2014	x		FT027			
KAWASAKI	1000	ZX-10R	2008	2010	x	x	FT082			
KAWASAKI	1000	ZX-10R	2006	2007	x		FT081			
KAWASAKI	1000	ZX-10R	2004	2005	x		FT080			

- BRAKE/CLUTCH MASTER CYLINDERS
- ACCESSORIES SPARE PARTS
- CNC-WORKED FLUID RESERVOIR
- FULL CLUTCH
- HYDRAULIC-CLUTCH TRANFORMATION KIT
- LEVER
- THROTTLE CONTROL
- BRAKE CALIPER
- RACING KIT
- BUTTON PANEL
- LEVER GUARD
- CLIP-ON
- STREET RACING REARSET
- FUEL CAPS
- STEERING NUT
- CRASH PADS
- PADDOCK STAND
- MIRROR COVERS
- REAR-VIEW MIRRORS
- FOG LIGHTS KIT
- HANDLEBARS ACCESSORIES
- HANDLEBARS

Marca Brand	CC	Modello Model	Anno dal Form	Anno al To	Cambio / Shift		Codice Reference	Novità New	Colore Pedana Rearset colour	Colore inserti Insets colour
					Standard	Rovesciato/ Reversed				
KTM	1290	SUPER DUKE R	2014	2016	x		FT092		N ● nero - black	O ● arancione / orange
MV AGUSTA	675	F3 675 ORO	2012	2019	x		FT060	N		
MV AGUSTA	800	F3 800 AGO	2012	2019	x		FT060	N	N ● nero - black	
MV AGUSTA	800	F3 800 RC	2012	2019	x		FT060	N		
MV AGUSTA	800	F3(800)	2012	2019	x		FT060	N		
SUZUKI	600	GSX-R600	2011	2015	x	x	FT040			
SUZUKI	600	GSX-R600	2006	2010	x	x	FT039			
SUZUKI	650	SV 650	2016	2018	x		FT106	N		
SUZUKI	650	SV 650	1999	2002	x		FT090			
SUZUKI	750	GSR750	2011	2016	x		FT091			
SUZUKI	750	GSX-S750	2015	2016	x		FT091			
SUZUKI	750	GSX-R750	2006	2010	x	x	FT039		N ● nero - black	Y ● oro - gold
SUZUKI	1000	GSX-S1000/F	2015	2015	x		FT109	N		
SUZUKI	1000	GSX-R1000	2017	2019	x	x	FT101	N		
SUZUKI	1000	GSX-R1000	2009	2016	x	x	FT062			
SUZUKI	1000	GSX-R1000	2007	2008	x		FT035			
SUZUKI	1000	GSX-R1000	2005	2006	x		FT034			
SUZUKI	1300	GSX1300R HAYABUSA	2008	2016	x		FT037			
SUZUKI	1300	GSX1300R HAYABUSA	1999	2007	x		FT061			
TRIUMPH	675	DAYTONA 675/R	2013	2014	x	x	FT064		N ● nero - black	
TRIUMPH	1050	SPEED TRIPLE 1050	2011	2014	x		FT063			
TRIUMPH	1050	SPEED TRIPLE 1049	2005	2010	x		FT093			
YAMAHA	125	MT-25	2015	2016	x		FT087			
YAMAHA	250	YZF-R25	2015	2016	x	x	FT069			
YAMAHA	320	YZF-R3	2015	2018	x	x	FT069	N		
YAMAHA	320	MT-03	2015	2016	x	x	FT087			
YAMAHA	600	YZF-R6	2017	2019	x	x	FT107	N		
YAMAHA	600	YZF-R6	2006	2012	x	x	FT046			
YAMAHA	600	YZF-R6	2003	2005	x		FT045			
YAMAHA	700	FZ-07	2014	2016	x		FT089			
YAMAHA	700	MT-07	2014	2016	x		FT089			
YAMAHA	800	FZ8 (NON-ABS)	2010	2013	x		FT085			
YAMAHA	850	XSR900	2016	2019	x		FT088	N	N ● nero - black	B ● blu - blue
YAMAHA	850	FZ-09	2014	2016	x		FT088			
YAMAHA	850	MT-09	2014	2016	x		FT088			
YAMAHA	1000	MT-10	2016	2019	x	x	FT103	N		
YAMAHA	1000	YZF-R1	2015	2019	x	x	FT070	N		
YAMAHA	1000	FZ-10	2016	2017	x	x	FT103			
YAMAHA	1000	YZF-R1M	2015	2017	x	x	FT070	N		
YAMAHA	1000	FZ1	2006	2016	x		FT085			
YAMAHA	1000	YZF-R1(RACING)	2015	2016	x	x	FT071			
YAMAHA	1000	YZF-R1	2009	2014	x	x	FT067			
YAMAHA	1000	YZF-R1	2007	2008	x	x	FT096			
YAMAHA	1000	YZF-R1	2004	2006	x		FT066			

Codice Reference	Descrizione Description
KPD1	Kit ricambio pedana (pioli, inserti e rondelle) / Spare parts kit (Pins, inserts, washers)
KPD2	Pioli di ricambio per pedane universali (venduti a coppie) / Pins for spare part rearsset universal (sold in pairs)
KPD3	Inserti e rondelle di ricambio per pedane / Spare parts insert and washers for rearsset
KPD4	Poggiapiedi di ricambio per pedane universali (venduti a coppie) / Spare parts footrest for rearsset universal (sold in pairs)

BRAKE/CLUTCH
MASTER CYLINDERS
 ACCESSORIES
SPARE PARTS
 CNC-WORKED FLUID
RESERVOIR
 FULL CLUTCH
 HYDRAULIC-CLUTCH
TRANFORMATION KIT
 LEVER
 THROTTLE CONTROL
 BRAKE CALIPER
 RACING KIT
 BUTTON PANEL
 LEVER GUARD
 CLIP-ON
 STREET RACING
REARSET
 FUEL CAPS
 STEERING NUT
 CRASH PADS
 PADDOCK STAND
 MIRROR COVERS
 REAR-VIEW MIRRORS
 FOG LIGHTS KIT
 HANDLEBARS
ACCESSORIES
 HANDLEBARS

PEDANE TOURING

TOURING REARSETS



Colori / Colours

N ●

Pedana nera
black rearset

R ●

Inserto rosso
Red insert

BRAKE/CLUTCH
MASTER CYLINDERS
ACCESSORIES
SPARE PARTS
CNC-WORKED FLUID
RESERVOIR
FULL CLUTCH
HYDRAULIC-CLUTCH
TRANSFORMATION KIT
LEVER
THROTTLE CONTROL
BRAKE CALIPER
RACING KIT
BUTTON PANEL
LEVER GUARD
CLIP-ON
STREET RACING
REARSET
FUEL CAPS
STEERING NUT
CRASH PADS
Paddock STAND
MIRROR COVERS
REAR-VIEW MIRRORS
FOG LIGHTS KIT
HANDLEBARS
ACCESSORIES
HANDLEBARS

FT102 - Applicazioni / Application list

Marca Brand	CC	Modello Model	Anno dal From	Anno al To	Novità New	Marca Brand	CC	Modello Model	Anno dal From	Anno al To	Novità New
DUCATI	800	SCRAMBLER DESERT SLED	2017	2020		DUCATI	1198	MULTISTRADA 1200 ENDURO	2016	2018	
DUCATI	800	SCRAMBLER DESERT SLED THAILAND	2017	2018	N	DUCATI	1198	MULTISTRADA 1200 ABS SPORT PACK	2017	2018	
DUCATI	800	SCRAMBLER DESERT SLED USA	2019	2020	N	DUCATI	1198	MULTISTRADA 1200 ENDURO PRO	2018	2018	
DUCATI	821	HYPERSTRADA	2013	2015	N	DUCATI	1198	MULTISTRADA 1200 ENDURO PRO USA	2018	2018	
DUCATI	821	HYPERSTRADA BRASIL	2014	2016	N	DUCATI	1198	MULTISTRADA 1200 ENDURO THAILAND	2016	2019	N
DUCATI	821	HYPERSTRADA LOW SEAT	2015	2015		DUCATI	1198	MULTISTRADA 1200 ENDURO TOURING	2016	2018	N
DUCATI	821	HYPERSTRADA THAILAND	2016	2017		DUCATI	1198	MULTISTRADA 1200 ENDURO USA	2016	2018	N
DUCATI	821	HYPERSTRADA USA	2013	2015		DUCATI	1198	MULTISTRADA 1200 S THAILAND	2016	2018	N
DUCATI	821	HYPERMOTARD	2013	2015		DUCATI	1198	MULTISTRADA 1200 S TOURING	2011	2017	
DUCATI	821	HYPERMOTARD BRASIL	2014	2016		DUCATI	1200	MULTISTRADA 1200 ABS	2011	2017	
DUCATI	821	HYPERMOTARD LOW SEAT	2015	2015		DUCATI	1200	MULTISTRADA 1200 ABS BRASIL	2014	2018	N
DUCATI	821	HYPERMOTARD SP	2013	2015		DUCATI	1200	MULTISTRADA 1200 ABS THAILAND	2014	2018	N
DUCATI	821	HYPERMOTARD SP USA	2013	2015		DUCATI	1200	MULTISTRADA 1200 ABS USA	2011	2017	N
DUCATI	821	HYPERMOTARD THAILAND	2015	2015		DUCATI	1200	MULTISTRADA 1200 S ABS	2015	2017	N
DUCATI	821	HYPERMOTARD USA	2013	2014		DUCATI	1200	MULTISTRADA 1200 S ABS USA	2015	2017	N
DUCATI	936	HYPERSTRADA 939	2016	2016		DUCATI	1200	MULTISTRADA 1200 S D-AIR	2016	2017	N
DUCATI	936	HYPERSTRADA 939 THAILAND	2016	2017		DUCATI	1200	MULTISTRADA 1200 S GT	2013	2014	N
DUCATI	936	HYPERSTRADA 939 USA	2016	2016		DUCATI	1200	MULTISTRADA 1200 S GT USA	2013	2014	N
DUCATI	936	HYPERMOTARD 939	2016	2018		DUCATI	1200	MULTISTRADA 1200 S PIKES PEAK	2012	2017	N
DUCATI	936	HYPERMOTARD 939 SP / SP U	2016	2018		DUCATI	1200	MULTISTRADA 1200 S PIKES PEAK BR	2014	2015	N
DUCATI	936	HYPERMOTARD 939 THAILAND	2016	2019		DUCATI	1200	MULTISTRADA 1200 S PIKES PEAK TH	2014	2017	N
DUCATI	936	HYPERMOTARD 939 USA	2016	2018		DUCATI	1200	MULTISTRADA 1200 S PIKES PEAK US	2012	2017	N
DUCATI	936	MULTISTRADA 950	2017	2020	N	DUCATI	1200	MULTISTRADA 1200 S SPORT	2011	2012	N
DUCATI	936	MULTISTRADA 950 BRASIL	2018	2018		DUCATI	1200	MULTISTRADA 1200 S SPORT USA	2011	2012	N
DUCATI	936	MULTISTRADA 950 S	2019	2020	N	DUCATI	1200	MULTISTRADA 1200 S TOURING BRASIL	2014	2018	N
DUCATI	936	MULTISTRADA 950 S SW	2019	2020	N	DUCATI	1200	MULTISTRADA 1200 S TOURING D-AIR	2016	2017	N
DUCATI	936	MULTISTRADA 950 S SW THAILAND	2019	2019	N	DUCATI	1200	MULTISTRADA 1200 S TOURING THAILAND	2014	2014	N
DUCATI	936	MULTISTRADA 950 S SW USA	2019	2020	N	DUCATI	1200	MULTISTRADA 1200 S TOURING USA	2011	2017	N
DUCATI	936	MULTISTRADA 950 S THAILAND	2019	2019		DUCATI	1200	MULTISTRADA 1200 TOURING	2015	2017	N
DUCATI	936	MULTISTRADA 950 S TOURING	2019	2020		DUCATI	1200	MULTISTRADA 1200 TOURING USA	2015	2017	N
DUCATI	936	MULTISTRADA 950 S USA	2019	2020		DUCATI	1200	MULTISTRADA 1200 USA	2011	2012	N
DUCATI	936	MULTISTRADA 950 SW	2018	2018	N	DUCATI	1262	MULTISTRADA 1260 ABS	2018	2020	N
DUCATI	936	MULTISTRADA 950 SW THAILAND	2017	2018	N	DUCATI	1262	MULTISTRADA 1260 ABS BRASIL	2018	2019	N
DUCATI	936	MULTISTRADA 950 SW USA	2018	2018	N	DUCATI	1262	MULTISTRADA 1260 ABS THAILAND	2018	2019	N
DUCATI	936	MULTISTRADA 950 THAILAND	2017	2019		DUCATI	1262	MULTISTRADA 1260 ABS USA	2018	2020	N
DUCATI	936	MULTISTRADA 950 TOURING	2017	2018		DUCATI	1262	MULTISTRADA 1260 ENDURO THAILAND	2019	2019	N
DUCATI	936	MULTISTRADA 950 TOURING THAILAND	2017	2017		DUCATI	1262	MULTISTRADA 1260 ENDURO TOURING	2019	2020	N
DUCATI	936	MULTISTRADA 950 TOURING USA	2018	2018		DUCATI	1262	MULTISTRADA 1260 ENDURO USA	2019	2019	N
DUCATI	936	MULTISTRADA 950 USA	2017	2020		DUCATI	1262	MULTISTRADA 1260 S ABS	2018	2020	N
DUCATI	950	HYPERMOTARD 950	2019	2019		DUCATI	1262	MULTISTRADA 1260 S ABS D-AIR	2018	2020	N
DUCATI	950	HYPERMOTARD 950 SP / SP U	2019	2019		DUCATI	1262	MULTISTRADA 1260 S ABS THAILAND	2018	2019	N
DUCATI	950	HYPERMOTARD 950 USA	2019	2019		DUCATI	1262	MULTISTRADA 1260 S ABS USA	2018	2020	N
DUCATI	1079	SCRAMBLER 1100	2018	2018		DUCATI	1262	MULTISTRADA 1260 S PIKES PEAK	2018	2020	N
DUCATI	1079	SCRAMBLER 1100 SPECIAL	2018	2019		DUCATI	1262	MULTISTRADA 1260 S PIKES PEAK THAILAND	2018	2019	N
DUCATI	1079	SCRAMBLER 1100 SPECIAL/SPORT THAILAND	2019	2019		DUCATI	1262	MULTISTRADA 1260 S PIKES PEAK USA	2018	2020	N
DUCATI	1079	SCRAMBLER 1100 SPECIAL/SPORT USA	2018	2018	N	DUCATI	1262	MULTISTRADA 1260 S TOURING	2018	2020	N
DUCATI	1079	SCRAMBLER 1100 SPORT	2018	2019		DUCATI	1262	MULTISTRADA 1260 S TOURING BRASIL	2018	2019	N
DUCATI	1079	SCRAMBLER 1100 THAILAND	2019	2019	N	DUCATI	1262	MULTISTRADA 1260 S TOURING USA	2018	2020	N
DUCATI	1079	SCRAMBLER 1100 USA	2018	2019		DUCATI	1262	MULTISTRADA 1260 TOURING	2018	2020	N
DUCATI	1198	MULTISTRADA 1200	2011	2012		DUCATI	1262	MULTISTRADA 1260 TOURING USA	2018	2020	N

BRAKE/CLUTCH MASTER CYLINDERS
 ACCESSORIES SPARE PARTS
 CNC-WORKED FLUID RESERVOIR
 FULL CLUTCH
 HYDRAULIC-CLUTCH TRANFORMATION KIT
 LEVER
 THROTTLE CONTROL
 BRAKE CALIPER
 RACING KIT
 BUTTON PANEL
 LEVER GUARD
 CLIP-ON
 STREET RACING REARSET
 FUEL CAPS
 STEERING NUT
 CRASH PADS
 PADDOCK STAND
 MIRROR COVERS
 REAR-VIEW MIRRORS
 FOG LIGHTS KIT
 HANDLEBARS ACCESSORIES
 HANDLEBARS

TAPPI SERBATOIO

FUEL-CAPS



STANDARD MODEL



NEW MODEL

Colori (asola nottolino gruppo chiusura) / Flap colours

N ●
nero - black

Y ●
oro - gold

B ●
blu - blue

R ●
rosso - red

G ●
verde - green

S ●
argento -

- BRAKE/CLUTCH MASTER CYLINDERS
- ACCESSORIES SPARE PARTS
- CNC-WORKED FLUID RESERVOIR
- FULL CLUTCH
- HYDRAULIC-CLUTCH TRANSFORMATION KIT
- LEVER
- THROTTLE CONTROL
- BRAKE CALIPER
- RACING KIT
- BUTTON PANEL
- LEVER GUARD
- CLIP-ON
- STREET RACING REARSET
- FUEL CAPS
- STEERING NUT
- CRASH PADS
- Paddock STAND
- MIRROR COVERS
- REAR-VIEW MIRRORS
- FOG LIGHTS KIT
- HANDLEBARS ACCESSORIES
- HANDLEBARS

Applicazioni / Application list

Marca Brand	CC	Modello Model	Dal From	Al To	Modello Standard Model	Nuovo Modello New Model	Novità New	Marca Brand	CC	Modello Model	Dal From	Al To	Modello Standard Model	Nuovo Modello New Model	Novità New
Aprilia	50	Rs4 50	2011	2019	FC001		N	Ducati	659	Monster 696 / Abs	2011	2014	FC005		
Aprilia	50	Rs4 50 Replica	2014	2016	FC001		N	Ducati	695	Monster 695	2007	2008	FC004	FC104	N
Aprilia	125	Rs 125	1999	2019	FC001		N	Ducati	748	748	1995	2001	FC004	FC104	N
Aprilia	125	Rs 125 4T Abs	2021	2021	FC001		N	Ducati	748	748 E	2001	2002	FC004	FC104	N
Aprilia	125	Rs 125 Replica	2017	2019	FC001		N	Ducati	748	748 R Single Seat	1998	2002	FC004	FC104	N
Aprilia	125	Rs GP 125 Replica	2021	2022	FC001		N	Ducati	748	748 Rs	2000	2000	FC004	FC104	N
Aprilia	125	Rs4 125	2011	2018	FC001		N	Ducati	748	748 S	2000	2002	FC004	FC104	N
Aprilia	125	Rs4 125 Replica	2014	2019	FC001		N	Ducati	748	748 Sps	1998	1999	FC004	FC104	N
Aprilia	125	Tuono 125	2003	2004	FC001		N	Ducati	749	749 / S	2003	2004	FC006		
Aprilia	125	Tuono 125 Abs	2020	2020	FC001		N	Ducati	750	Monster 750	1996	2002	FC004	FC104	N
Aprilia	125	Tuono 125 Abs	2017	2018	FC001		N	Ducati	750	Monster 750 Dark / City	1999	1999	FC004	FC104	N
Aprilia	250	Rs 250 – 6 Holes	1995	2003	FC001			Ducati	750	Supersport 750 Ss	1999	2002	FC004	FC104	N
Aprilia	650	Moto' 6.5	1995	1999	FC001		N	Ducati	796	Monster 796 / Abs	2011	2014	FC005		
Aprilia	650	Pegaso 3 / I.E.	1997	2004	FC001		N	Ducati	796	Monster 796 Anniversary	2013	2013	FC005		N
Aprilia	660	RS 660 T1	2020	2022	FC001		N	Ducati	800	Hypermotard 796	2010	2012	FC008		N
Aprilia	660	Tuono 660	2021	2022	FC001		N	Ducati	800	Monster 797 / Plus	2017	2019	FC004	FC104	N
Aprilia	750	Shiver 750	2007	2016	FC001		N	Ducati	800	Monster 800	2003	2004	FC004	FC104	N
Aprilia	750	Shiver 750 Gt	2009	2009	FC001		N	Ducati	800	Monster S2R 800 / Dark	2005	2007	FC004	FC104	N
Aprilia	900	Shiver 900	2017	2019	FC001		N	Ducati	800	Scrambler 800 Cafe Racer	2017	2020	FC005		N
Aprilia	1000	Etv Capo Nord / Rally / Abs	2001	2007	FC001		N	Ducati	800	Scrambler 800 Classic	2015	2018	FC005		N
Aprilia	1000	Rst Futura	2001	2003	FC001		N	Ducati	800	Scrambler 800 Desert Sled	2017	2022	FC005		N
Aprilia	1000	Rsv 1000	2000	2003	FC001			Ducati	800	Scrambler 800 Full Throttle	2015	2020	FC005		N
Aprilia	1000	Rsv 1000 R / Factory / Dream	2004	2008	FC002	FC102		Ducati	800	Scrambler 800 Icon	2015	2022	FC005		N
Aprilia	1000	Rsv4 Aprc R	2011	2014	FC002	FC102	N	Ducati	800	Scrambler 800 Mach 2.0	2018	2018	FC005		N
Aprilia	1000	Rsv4 Factory / Sbk Racing	2009	2010	FC002	FC102	N	Ducati	800	Scrambler 800 Street Classic	2018	2018	FC005		N
Aprilia	1000	Rsv4 Factory Abs	2021	2022	FC002	FC102	N	Ducati	800	Scrambler Italia Independent	2016	2016	FC005		N
Aprilia	1000	Rsv4 Factory Aprc	2011	2014	FC002	FC102	N	Ducati	800	Supersport 800 Ss	2003	2005	FC004	FC104	N
Aprilia	1000	Rsv4 R	2009	2010	FC002	FC102	N	Ducati	821	Hypermotard 821 / Sp	2013	2015	FC008		N
Aprilia	1000	Rsv4 Racing Factory Abs	2018	2020	FC002	FC102		Ducati	821	Hypermotard 821 Low Seat	2015	2015	FC008		N
Aprilia	1000	Rsv4 Racing Factory Le	2015	2017	FC002	FC102	N	Ducati	821	Hyperstrada 821	2013	2015	FC008		N
Aprilia	1000	Rsv4 RR	2015	2018	FC002	FC102	N	Ducati	821	Monster 821	2015	2020	FC004	FC104	
Aprilia	1000	SI Falco	2000	2003	FC001		N	Ducati	821	Monster 821 Dark	2015	2021	FC004	FC104	
Aprilia	1000	Tuono	2003	2018	FC001		N	Ducati	821	Monster 821 Stealth	2019	2021	FC004	FC104	
Aprilia	1100	Rsv4 R / Rr / Rf / Factory / 1100	2009	2021	FC002	FC102		Ducati	821	Monster 821 Stripes	2015	2017	FC004	FC104	N
Aprilia	1100	Tuono / V4 / Rr / 1100	2005	2021	FC002	FC102		Ducati	848	848	2008	2010	FC004	FC104	
Aprilia	1100	Tuono V4 E5	2021	2021	FC002	FC102	N	Ducati	848	848 Evo	2011	2013	FC004	FC104	N
Aprilia	1100	Tuono V4 Factory	2015	2017	FC002	FC102	N	Ducati	848	848 Hayden	2010	2010	FC004	FC104	N
Aprilia	1100	Tuono V4 Factory Superpole Euro 4	2019	2020	FC002	FC102		Ducati	848	Evo Corse Se	2012	2013	FC004	FC104	N
Bmw	800	F 800 R	2009	2018	FC003	FC103	N	Ducati	848	Streetfighter / 848	2015	2015	FC005		
Bmw	1000	S 1000Rr / Hp4	2010	2021	FC003	FC103		Ducati	851	851	1991	1991	FC004	FC104	N
Bmw	1000	S1000R Naked	2014	2021	FC003	FC103		Ducati	899	Panigale 899 Abs	2014	2015	FC005		N
Bmw	1170	HP2 Sport	2008	2011	FC003	FC103	N	Ducati	900	Monster 900	1993	2002	FC004	FC104	N
Bmw	1200	R 1200 Gs	2008	2012	FC003	FC103		Ducati	900	Monster 900 S / Dark / Cromo / City	1998	1999	FC004	FC104	N
Bmw	1200	R Nine T Scrambler	2015	2021	FC003	FC103		Ducati	900	Supersport 900 Ss	1998	2002	FC004	FC104	N
Ducati	400	Monster 400	1995	2008	FC004	FC104	N	Ducati	916	916	1994	1997	FC004	FC104	N
Ducati	400	Scrambler 400 Hashtag	2018	2018	FC005		N	Ducati	916	916 Senna	1994	1998	FC004	FC104	N
Ducati	400	Scrambler 400 Sixty 2	2016	2020	FC005		N	Ducati	916	916 Sp	1994	1996	FC004	FC104	N
Ducati	600	Monster 600	1993	2001	FC004	FC104	N	Ducati	916	916 Sps	1997	1998	FC004	FC104	N
Ducati	600	Monster 600 Dark / City	1998	1999	FC004	FC104	N	Ducati	936	Hypermotard 939 / Sp / Sp U	2016	2018	FC008		N
Ducati	620	Monster 620 / Dark	2002	2006	FC004	FC104	N	Ducati	936	Supersport 939 / S	2017	2020	FC004	FC104	
Ducati	620	Multistrada 620	2006	2006	FC006		N	Ducati	944	Sport Touring St2	1997	2003	FC004	FC104	N

BRAKE/CLUTCH MASTER CYLINDERS
 ACCESSORIES SPARE PARTS
 CNC-WORKED FLUID RESERVOIR
 FULL CLUTCH
 HYDRAULIC-CLUTCH TRANFORMATION KIT
 LEVER
 THROTTLE CONTROL
 BRAKE CALIPER
 RACING KIT
 BUTTON PANEL
 LEVER GUARD
 CLIP-ON
 STREET RACING REARSET
 FUEL CAPS
 STEERING NUT
 CRASH PADS
 PADDOCK STAND
 MIRROR COVERS
 REAR-VIEW MIRRORS
 FOG LIGHTS KIT
 HANDLEBARS ACCESSORIES
 HANDLEBARS

Marca Brand	CC	Modello Model	Dal From	Al To	Modello Standard Model	Nuovo Modello New Model	Novità New	Marca Brand	CC	Modello Model	Dal From	Al To	Modello Standard Model	Nuovo Modello New Model	Novità New
Ducati	950	Hypermotard 950 / Sp	2019	2022	FC007			Ducati	1200	Multistrada 1200 S Sport	2011	2012	FC007		N
Ducati	950	Multistrada 950	2017	2021	FC007			Ducati	1200	Multistrada 1200 S Touring	2010	2017	FC007		N
Ducati	950	Multistrada 950 S / S Sw / S Touring	2019	2021	FC007			Ducati	1200	Multistrada 1200 Touring	2015	2017	FC007		N
Ducati	950	Multistrada 950 Touring	2017	2018	FC007		N	Ducati	1260	Diavel 1260 / S	2019	2021	FC007		N
Ducati	950	Multistrada V2 / S	2022	2022	FC007		N	Ducati	1260	Multistrada 1260 Abs / S Abs	2018	2020	FC007		N
Ducati	955	Panigale Corse / U	2018	2019	FC005		N	Ducati	1260	Multistrada 1260 S D-Air	2018	2020	FC007		N
Ducati	955	Panigale V2	2020	2022	FC005		N	Ducati	1260	Multistrada 1260 S Pikes Peak	2018	2020	FC007		N
Ducati	959	Panigale 959 Abs	2017	2019	FC005		N	Ducati	1260	Multistrada Touring / S	2018	2020	FC007		N
Ducati	991	Sport Touring St4	1999	2003	FC004	FC104	N	Ducati	1260	X Diavel	2016	2021	FC005		N
Ducati	996	996	1999	2001	FC004	FC104	N	Ducati	1260	X Diavel S	2016	2021	FC005		N
Ducati	996	996 S / R / R li	2001	2001	FC004	FC104	N	Ducati	1299	Panigale 1299 / R	2012	2015	FC005		N
Ducati	996	996 Sps / Sps li / Sps lii	1999	2000	FC004	FC104	N	Ducati	1300	1299 Abs / S Abs	2015	2017	FC005		N
Ducati	996	Sport Touring St4 S / S Abs	2004	2005	FC004	FC104	N	Honda	150	Cbr 150 R	2016	2017	FC025	FC125	N
Ducati	998	998	2002	2003	FC004	FC104	N	Honda	400	CBR 400 RR	1983	1994	FC009	FC109	N
Ducati	998	998 Matrix / Final Ed.	2004	2004	FC004	FC104	N	Honda	400	RVF 400	1994	1996	FC009	FC109	N
Ducati	998	998 R S Bayliss / S Bostrom	2002	2002	FC004	FC104	N	Honda	400	VFR 400	1990	1990	FC009	FC109	N
Ducati	999	999 / R / S	2003	2004	FC006			Honda	500	Cbr 500 F / R	2016	2020	FC025	FC125	
Ducati	1000	Gt 1000 / Sport 1000	2007	2010	FC006			Honda	600	CB 600 F / Hornet / 599	2000	2000	FC009	FC109	N
Ducati	1000	Gt 1000 Touring	2009	2009	FC006		N	Honda	600	Cbr 600 F	1999	2006	FC009	FC109	
Ducati	1000	Monster 1000 / S	2003	2005	FC004	FC104	N	Honda	600	CBR 600 F4I	2000	2000	FC009	FC109	N
Ducati	1000	Monster S2R 1000	2006	2008	FC004	FC104	N	Honda	600	Cbr 600 Rr	2003	2021	FC009	FC109	
Ducati	1000	Monster S4Rs	2006	2007	FC004	FC104	N	Honda	600	Hornet 600	2002	2002	FC009	FC109	
Ducati	1000	Mosnter S4R	2003	2008	FC004	FC104	N	Honda	650	Cbr 650 R / F	2015	2020	FC025	FC125	
Ducati	1000	Multistrada 1000	2003	2006	FC006			Honda	650	Hawk GT NT 650	1988	1991	FC009	FC109	N
Ducati	1000	Multistrada 1000 S	2005	2006	FC006		N	Honda	750	VFR 750	1990	1990	FC009	FC109	N
Ducati	1000	Sport Touring St3	2004	2007	FC004	FC104	N	Honda	800	VFR 800	1990	1990	FC009	FC109	N
Ducati	1000	Sport Touring St3 S Abs	2006	2007	FC004	FC104	N	Honda	900	Cbr 900 Rr	1995	2004	FC009	FC109	
Ducati	1000	Supersport 1000 Ss	2003	2006	FC004	FC104	N	Honda	900	CBR 900 RR	1992	1993	FC009	FC109	N
Ducati	1079	Scrambler 1100 / Sport / Special	2018	2019	FC005		N	Honda	929	CBR 929 RR	2000	2000	FC009	FC109	N
Ducati	1098	1098 / S / S Tricolore	2007	2008	FC004	FC104	N	Honda	954	CBR 954 RR	2002	2002	FC009	FC109	N
Ducati	1098	1098 R / R Bayliss	2009	2009	FC004	FC104	N	Honda	1000	CB 1000	1992	1997	FC009	FC109	N
Ducati	1100	Hypermotard 1100 / S	2008	2009	FC008		N	Honda	1000	CB 1000 R	1995	1995	FC009	FC109	N
Ducati	1100	Hypermotard 1100 Evo / Sp	2010	2012	FC008		N	Honda	1000	CBF 1000	2000	2000	FC009	FC109	N
Ducati	1100	Monster 1100	2009	2010	FC005			Honda	1000	Cbr 1000 Rr	2004	2013	FC009	FC109	
Ducati	1100	Monster 1100 Diesel	2013	2013	FC005		N	Honda	1000	CBR 1000 RR / Fireblade	2000	2000	FC009	FC109	N
Ducati	1100	Monster 1100 Evo Abs / Anniversary	2013	2013	FC005		N	Honda	1000	Cbr 1000 Rr / Sp	2014	2016	FC010		
Ducati	1100	Monster 1100 S Abs	2010	2010	FC005		N	Honda	1000	Cbr 1000 Rr / Sp / Sp2	2017	2021	FC025	FC125	
Ducati	1100	Panigale V4 / S / Speciale / R	2015	2020	FC005			Honda	1000	Vtr 1000 Sp1 / Sp2	2000	2006	FC009	FC109	N
Ducati	1100	Streetfighter V4 / S	2020	2022	FC005		N	Honda	1000	VTR1000F / Firestorm / SuperHawk	2000	2000	FC009	FC109	N
Ducati	1198	1198 / R / S / Sp	2009	2011	FC004	FC104	N	Honda	1100	CBR 1100 XX / Super Blackbird	1996	2007	FC009	FC109	N
Ducati	1199	1199 Panigale Superleggera	2014	2014	FC005		N	Honda	1100	CBR 1100 XX Blackbird	2000	2000	FC009	FC109	N
Ducati	1200	Monster 1200	2014	2020	FC004	FC104	N	Honda	1200	VFR1200F	2008	2008	FC009	FC109	N
Ducati	1200	Monster 1200 / S	2014	2020	FC004	FC104	N	Honda	1300	CB 1300 / CB 1300 S	2000	2000	FC009	FC109	N
Ducati	1200	Monster 1200 R	2016	2019	FC004	FC104	N	Kawasaki	125	Ninja 125	2021	2022	FC026	FC126	N
Ducati	1200	Monster 1200 S	2014	2020	FC004	FC104	N	Kawasaki	125	Z 125	2021	2022	FC026	FC126	N
Ducati	1200	Multistrada 1200	2010	2012	FC007		N	Kawasaki	230	Klx 230	2020	2020	FC026	FC126	N
Ducati	1200	Multistrada 1200 Abs	2010	2017	FC007		N	Kawasaki	250	GPZ250 / GPX250	1988	2007	FC011	FC111	N
Ducati	1200	Multistrada 1200 Abs Sport Pack	2017	2017	FC007		N	Kawasaki	250	Ninja 250R / 250 / EX250	1988	2007	FC011	FC111	N
Ducati	1200	Multistrada 1200 Enduro	2016	2018	FC007		N	Kawasaki	250	Zr 250	1996	2003	FC011	FC111	N
Ducati	1200	Multistrada 1200 Enduro Touring	2016	2018	FC007		N	Kawasaki	300	Kle 300 Versys-X Abs	2017	2022	FC026	FC126	N
Ducati	1200	Multistrada 1200 S Abs	2015	2017	FC007		N	Kawasaki	400	Ninja 400	2017	2022	FC026	FC126	N
Ducati	1200	Multistrada 1200 S D-Air	2016	2017	FC007		N	Kawasaki	400	Z 400	2019	2022	FC026	FC126	
Ducati	1200	Multistrada 1200 S Gt	2013	2014	FC007		N	Kawasaki	400	Zr 400	1991	1999	FC011	FC111	N
Ducati	1200	Multistrada 1200 S Pikes Peak	2012	2017	FC007		N	Kawasaki	400	Zr 400 H2	1990	1990	FC011	FC111	N

- BRAKE/CLUTCH MASTER CYLINDERS
- ACCESSORIES SPARE PARTS
- CNC-WORKED FLUID RESERVOIR
- FULL CLUTCH
- HYDRAULIC-CLUTCH TRANFORMATION KIT
- LEVER
- THROTTLE CONTROL
- BRAKE CALIPER
- RACING KIT
- BUTTON PANEL
- LEVER GUARD
- CLIP-ON
- STREET RACING REARSET
- FUEL CAPS
- STEERING NUT
- CRASH PADS
- PADDOCK STAND
- MIRROR COVERS
- REAR-VIEW MIRRORS
- FOG LIGHTS KIT
- HANDLEBARS ACCESSORIES
- HANDLEBARS

Marca Brand	CC	Modello Model	Dal From	Al To	Modello Standard Standard Model	Nuovo Modello New Model	Novità New	Marca Brand	CC	Modello Model	Dal From	Al To	Modello Standard Standard Model	Nuovo Modello New Model	Novità New
Kawasaki	500	Er-5	2001	2005	FC012	FC112	N	Kawasaki	1200	ZRX-1200	1999	2000	FC011	FC111	N
Kawasaki	500	Gpz 500 S	1987	2003	FC011	FC111	N	Kawasaki	1200	Zr 1200	2002	2005	FC012	FC112	N
Kawasaki	500	Kle 500	1991	2004	FC011	FC111	N	Kawasaki	1400	Gtr 1400	2008	2014	FC013	FC113	N
Kawasaki	500	Ninja 500 / EX500 / 500R	1987	2001	FC011	FC111	N	Kawasaki	1400	Gtr 1400 Abs	2015	2018	FC013	FC113	N
Kawasaki	600	ZX-6 / ZX-6E	1993	2001	FC011	FC111	N	Kawasaki	1400	Zr-1400	2006	2011	FC013	FC113	N
Kawasaki	600	Zx-6R	1995	1999	FC011	FC111		Ktm	390	Duke 390 / Rc 390	2017	2021	FC027		
Kawasaki	600	Zr 600	1993	2005	FC011	FC111	N	Ktm	690	Duke 690 / R	2013	2017	FC014		N
Kawasaki	636	Zx-6 R /Rr - 636	2000	2006	FC012	FC112		Ktm	790	Duke 790	2018	2021	FC027		
Kawasaki	636	Zx-6R / 636	2019	2022	FC026	FC126		Ktm	990	Super Duke 990	2005	2013	FC014		
Kawasaki	636	Zx-6R / Abs	2007	2017	FC013	FC113		Ktm	1150	Rc8 / R	2008	2015	FC015	FC115	
Kawasaki	650	Er-6F / Abs	2006	2016	FC013	FC113	N	Ktm	1290	1290 Super Duke R	2014	2021	FC016		
Kawasaki	650	Er-6N / Abs	2005	2016	FC013	FC113	N	Mv Agusta	675	Brutale 675	2012	2020	FC020		
Kawasaki	650	Ninja 650	2017	2022	FC026	FC126		Mv Agusta	675	F3 675	2012	2020	FC020		
Kawasaki	650	Versys 650	2022	2022	FC026	FC126	N	Mv Agusta	750	F4 750	1999	2003	FC018	FC118	N
Kawasaki	650	Versys 650	2006	2018	FC013	FC113	N	Mv Agusta	800	Brutale 800	2012	2019	FC020		N
Kawasaki	650	Versys 650 Abs	2007	2014	FC013	FC113	N	Mv Agusta	800	Brutale 800 Rr	2012	2019	FC020		N
Kawasaki	650	Z 650	2017	2022	FC026	FC126		Mv Agusta	800	Brutale Dragster 800	2014	2019	FC020		N
Kawasaki	650	Z 650 RS	2022	2022	FC026	FC126	N	Mv Agusta	800	Brutale Dragster 800 Rc	2014	2019	FC020		N
Kawasaki	750	Z 750	2007	2013	FC013	FC113	N	Mv Agusta	800	Brutale Dragster 800 Rr	2014	2019	FC020		N
Kawasaki	750	Z 750 / S	2004	2006	FC012	FC112		Mv Agusta	800	F3 800	2012	2020	FC020		
Kawasaki	750	Zr 750 Zephyr	1991	1994	FC011	FC111	N	Mv Agusta	800	F3 800 Rc	2012	2019	FC020		N
Kawasaki	750	Zr-7	1999	2003	FC011	FC111	N	Mv Agusta	800	Rivale 800	2014	2019	FC020		N
Kawasaki	750	Zx-7 R	1998	2016	FC011	FC111		Mv Agusta	800	Rvs #1	2018	2018	FC020		N
Kawasaki	750	Zx-7 Rr	1996	1999	FC011	FC111	N	Mv Agusta	1000	Brutale 1000 T2 RR / Serie oro / Rush	2020	2021	FC019	FC119	N
Kawasaki	750	Zxr 750	1990	1998	FC011	FC111	N	Mv Agusta	1000	F4	2010	2019	FC019	FC119	N
Kawasaki	750	Zxr 750 H1 Stinger	1989	1989	FC011	FC111	N	Mv Agusta	1000	F4 1000 / R / Veltro	1997	2009	FC018	FC118	
Kawasaki	750	Zxr 750 H2 Stinger	1990	1990	FC011	FC111	N	Mv Agusta	1000	F4 Rc	2010	2019	FC019	FC119	N
Kawasaki	800	Z 800 / R	2007	2016	FC013	FC113	N	Mv Agusta	1000	F4 Rr	2010	2019	FC019	FC119	N
Kawasaki	900	Z900 / Abs	2017	2022	FC026	FC126		Mv Agusta	1078	F4 100CC / 312 RR	2007	2008	FC018	FC118	N
Kawasaki	900	Zx-9 R	1994	1999	FC011	FC111	N	Mv Agusta	1090	Btutale 1090 R	2012	2015	FC019	FC119	N
Kawasaki	900	Zx-9R	2000	2005	FC012	FC112	N	Mv Agusta	1090	Btutale 1090 Rr	2012	2015	FC019	FC119	N
Kawasaki	1000	GTR1000 / ZG1000 Concours	1986	2006	FC011	FC111	N	Mv Agusta	--	Brutale 750 / 910 / 1078	1997	2009	FC018	FC118	
Kawasaki	1000	Klz 1000 Versys	2019	2022	FC026	FC126		Mv Agusta	--	Brutale 920 / 990 / 1090 / Rr	2010	2019	FC019	FC119	N
Kawasaki	1000	Ninja 1000 Sx	2020	2020	FC026	FC126	N	Suzuki	250	DI 250 V-Strom	2018	2019	FC022		N
Kawasaki	1000	Ninja H2	2022	2022	FC026	FC126	N	Suzuki	250	Gsx-R 250	2017	2020	FC022		N
Kawasaki	1000	Ninja H2 / R	2016	2021	FC013	FC113		Suzuki	500	Gs 500	2001	2007	FC021	FC121	N
Kawasaki	1000	Versys 1000	2012	2018	FC013	FC113	N	Suzuki	600	Gsf 600 Bandit	2000	2004	FC021	FC121	N
Kawasaki	1000	Z 1000	2003	2006	FC012	FC112		Suzuki	600	Gsr 600	2006	2012	FC022		N
Kawasaki	1000	Z 1000 / R / Abs	2007	2020	FC013	FC113	N	Suzuki	600	Gsx-R 600	2004	2018	FC022		N
Kawasaki	1000	Z 1000 H2	2020	2022	FC026	FC126	N	Suzuki	600	Gsx-R 600	1996	2003	FC021	FC121	
Kawasaki	1000	Z1000 Sx	2010	2019	FC013	FC113	N	Suzuki	650	Bandit 650	2007	2012	FC022		N
Kawasaki	1000	Zx-10R	2021	2022	FC026	FC126	N	Suzuki	650	DI 650 V-Strom	2004	2011	FC021	FC121	N
Kawasaki	1000	Zx-10R	2004	2005	FC012	FC112		Suzuki	650	DI 650 V-Strom Abs	2012	2016	FC022		N
Kawasaki	1000	Zx-10R / Rr	2006	2020	FC013	FC113		Suzuki	650	Gladius 650	2009	2015	FC022		
Kawasaki	1100	Gpz 1100	1995	1997	FC011	FC111	N	Suzuki	650	Gsx-F 650	1998	2006	FC021	FC121	N
Kawasaki	1100	ZRX-1100	1999	2000	FC011	FC111	N	Suzuki	650	Gsx-F 650	2008	2012	FC022		N
Kawasaki	1100	ZRX-1100	2002	2004	FC011	FC111	N	Suzuki	650	Sv 650	2003	2020	FC022		
Kawasaki	1100	ZX-11	1995	1997	FC011	FC111	N	Suzuki	650	Sv 650	1999	2002	FC021	FC121	
Kawasaki	1100	ZX-11C / ZX-11D	1990	1993	FC011	FC111	N	Suzuki	650	Xf 650 Freewind	1997	2001	FC021	FC121	N
Kawasaki	1100	Zr 1100	1990	1998	FC011	FC111	N	Suzuki	750	Gsr 750	2010	2016	FC022		N
Kawasaki	1200	Zrx 1200	2001	2004	FC012	FC112	N	Suzuki	750	Gsx 750	1998	2001	FC021	FC121	N
Kawasaki	1200	Zrx 1200 R	2001	2006	FC012	FC112	N	Suzuki	750	Gsx-F 750	1998	2006	FC021	FC121	N
Kawasaki	1200	Zrx 1200 S	2001	2004	FC012	FC112	N	Suzuki	750	Gsx-R 750	2004	2018	FC022		N

- BRAKE/CLUTCH MASTER CYLINDERS
- ACCESSORIES SPARE PARTS
- CNC-WORKED FLUID RESERVOIR
- FULL CLUTCH
- HYDRAULIC-CLUTCH TRANFORMATION KIT
- LEVER
- THROTTLE CONTROL
- BRAKE CALIPER
- RACING KIT
- BUTTON PANEL
- LEVER GUARD
- CLIP-ON
- STREET RACING REARSET
- FUEL CAPS
- STEERING NUT
- CRASH PADS
- PADDOCK STAND
- MIRROR COVERS
- REAR-VIEW MIRRORS
- FOG LIGHTS KIT
- HANDLEBARS ACCESSORIES
- HANDLEBARS

Marca Brand	CC	Modello Model	Dal From	Al To	Modello Standard Standard Model	Nuovo Modello New Model	Novità New	Marca Brand	CC	Modello Model	Dal From	Al To	Modello Standard Standard Model	Nuovo Modello New Model	Novità New
Suzuki	750	Gsx-R 750	1996	2003	FC021	FC121		Yamaha	600	Fz 6 R	2009	2015	FC024	FC124	N
Suzuki	750	Gsx-S 750	2015	2020	FC022			Yamaha	600	Fzs Fazer 600	2002	2003	FC024	FC124	N
Suzuki	1000	DI 1000 V-Strom	2002	2010	FC021	FC121	N	Yamaha	600	TT 600 E / TT 600 S	1993	1999	FC024	FC124	N
Suzuki	1000	DI 1000 V-Strom	2018	2019	FC022		N	Yamaha	600	Xj6	2009	2015	FC024	FC124	N
Suzuki	1000	Gsx-R 1000	2003	2020	FC022			Yamaha	600	Xj6-N / Xj6-Na Abs	2009	2015	FC024	FC124	N
Suzuki	1000	Gsx-R 1000	2001	2002	FC021	FC121		Yamaha	600	Xj6-S Diversion / F Diversion / Fa Diversion Abs	2009	2011	FC024	FC124	N
Suzuki	1000	Gsx-S 1000	2015	2018	FC022		N	Yamaha	600	Yzf-R46	2005	2005	FC024	FC124	N
Suzuki	1000	Sv 1000	2003	2015	FC022			Yamaha	600	Yzf-R6	1999	2021	FC024	FC124	N
Suzuki	1000	TI 1000 R	1998	2000	FC021	FC121	N	Yamaha	600	Yzf-R6 50Th	2012	2012	FC024	FC124	N
Suzuki	1000	TI 1000 S	1997	2001	FC021	FC121	N	Yamaha	660	Xt 660 Z / Za Tenere	2010	2015	FC024	FC124	N
Suzuki	1200	Gsf 1200 Bandit	1996	2005	FC021	FC121		Yamaha	700	Fz-07	2017	2017	FC024	FC124	N
Suzuki	1200	Gsx 1200	1998	2001	FC021	FC121	N	Yamaha	700	Mt-07	2014	2017	FC024	FC124	N
Suzuki	1250	Bandit 1250	2006	2017	FC022			Yamaha	700	Xsr 700 Abs	2016	2016	FC024	FC124	N
Suzuki	1250	Gsx 1250 Fa	2010	2016	FC022		N	Yamaha	750	Fzr-750	2006	2016	FC024	FC124	
Suzuki	1300	Gsx-R 1300 Hayabusa	1999	2007	FC021	FC121		Yamaha	800	Fz 8 / Fazer	2010	2016	FC024	FC124	N
Suzuki	1300	Gsx-R 1300 Hayabusa	2008	2017	FC022			Yamaha	850	Fz-09	2017	2017	FC024	FC124	N
Suzuki	1400	Gsx 1400	2002	2007	FC021	FC121	N	Yamaha	850	Mxt 850 Niken / Niken Gt	2018	2019	FC024	FC124	N
Triumph	595	Daytona T595	1996	2002	FC023		N	Yamaha	900	Mt-09	2013	2016	FC024	FC124	N
Triumph	600	Speed Four	2002	2006	FC023		N	Yamaha	900	Tdm 900 / Abs	2002	2010	FC024	FC124	N
Triumph	675	Daytona 675	2013	2016	FC023			Yamaha	900	Xsr 900 Abs	2016	2016	FC024	FC124	N
Triumph	675	Street Triple	2008	2013	FC023			Yamaha	1000	Fz 1 / Fazer	2006	2013	FC024	FC124	N
Triumph	675	Street Triple 675 All Years	2008	2013	FC023		N	Yamaha	1000	Fz 1 / Fazer	2001	2005	FC024	FC124	
Triumph	800	Tiger	2010	2014	FC023			Yamaha	1000	Fz-10	2017	2017	FC024	FC124	N
Triumph	955	Daytona 955i	1998	2000	FC023		N	Yamaha	1000	Fzs Fazer 1000	2001	2005	FC024	FC124	N
Triumph	955	Speed Triple 955i	1999	2001	FC023		N	Yamaha	1000	Mt-10	2016	2021	FC024	FC124	
Triumph	1050	Speed Triple	2005	2013	FC023			Yamaha	1000	Yzf-R1	1998	2021	FC024	FC124	
Triumph	1050	Sprint 1050	2005	2005	FC023		N	Yamaha	1100	Bt Bulldog	2005	2006	FC024	FC124	N
Yamaha	125	Yzf-R125	2012	2012	FC024	FC124	N	Yamaha	1200	Super tenere / XT 1200 ZE	2012	2016	FC024	FC124	N
Yamaha	150	Fz 16	2011	2015	FC024	FC124	N	Yamaha	1200	V-Max	2009	2016	FC024	FC124	N
Yamaha	150	Yzf-R15	2013	2014	FC024	FC124	N	Yamaha	1200	Xjr 1200	1994	1997	FC024	FC124	N
Yamaha	250	Yzf-R25	2015	2018	FC024	FC124	N	Yamaha	1200	Xt 1200 Z / Ze Super Tenere	2013	2019	FC024	FC124	N
Yamaha	320	Mt-03	2016	2019	FC024	FC124	N	Yamaha	1300	Fjr 1300 / As / Abs	2001	2011	FC024	FC124	N
Yamaha	320	Yzf-R3	2015	2021	FC024	FC124	N	Yamaha	1300	Xjr 1300	2007	2011	FC024	FC124	N
Yamaha	600	Fz 6 / Fazer	2004	2016	FC024	FC124		Yamaha	1670	MT-01	2004	2009	FC024	FC124	N

Ricambi / Spare Part

Codice Reference	Specifiche tecniche Technical specifications
GC001	Nottolino gruppo chiusura tappo serbatoio rapido (codice FC0--) Flap quick-action fuel caps with (code FC0--)
GC101	Nottolino gruppo chiusura tappo serbatoio rapido (codice FC1--) Flap quick-action fuel caps (code FC1--)

Colori / Colours

N 	Y 	B 	R 	G 	S 
nero - black	oro - gold	blu - blue	rosso - red	verde - green	argento - silver

RC056	Guarnizione tappo serbatoio rapido Fuel caps gasket
-------	--

BRAKE/CLUTCH MASTER CYLINDERS
 ACCESSORIES SPARE PARTS
 CNC-WORKED FLUID RESERVOIR
 FULL CLUTCH
 HYDRAULIC-CLUTCH TRANFORMATION KIT
 LEVER
 THROTTLE CONTROL
 BRAKE CALIPER
 RACING KIT
 BUTTON PANEL
 LEVER GUARD
 CLIP-ON
 STREET RACING REARSET
 FUEL CAPS
 STEERING NUT
 CRASH PADS
 PADDOCK STAND
 MIRROR COVERS
 REAR-VIEW MIRRORS
 FOG LIGHTS KIT
 HANDLEBARS ACCESSORIES
 HANDLEBARS

TAPPO PER VASCHETTE ACCOSSATO CNC

CNC-WORKED FLUID RESERVOIR CAP



Codice Reference	Descrizione Description
TS001	Tappo vaschetta olio freno, lavorato CNC per vaschette Accossato, 30 ml (VG001) Brake fluid-reservoir cap, cnc-worked suitable for Accossato 30 ml-reservoir (VG001)
TS002	Tappo vaschetta olio frizione, lavorato CNC per vaschette Accossato, 15 ml (VP001) Clutch fluid-reservoir cap, cnc-worked suitable for Accossato 15 ml-reservoir (VP001)

BRAKE/CLUTCH
MASTER CYLINDERS

ACCESSORIES
SPARE PARTS

CNC-WORKED FLUID
RESERVOIR

FULL CLUTCH

HYDRAULIC-CLUTCH
TRANSFORMATION KIT

LEVER

THROTTLE CONTROL

BRAKE CALIPER

RACING KIT

BUTTON PANEL

LEVER GUARD

CLIP-ON

STREET RACING
REARSET

FUEL CAPS

STEERING NUT

CRASH PADS

Paddock STAND

MIRROR COVERS

REAR-VIEW MIRRORS

FOG LIGHTS KIT

HANDLEBARS
ACCESSORIES

HANDLEBARS

TAPPO VASCHETTA OLIO FRENO ANTERIORE

FRONT BRAKE OIL RESERVOIR CAP



Colori / Colours

N ●
nero - black

O ●
arancione
orange

Y ●
oro - gold

B ●
blu - blue

R ●
rosso - red

S ●
argento - silver

G ●
verde - green

BRAKE/CLUTCH
MASTER CYLINDERS

ACCESSORIES
SPARE PARTS

CNC-WORKED FLUID
RESERVOIR

FULL CLUTCH

HYDRAULIC-CLUTCH
TRANSFORMATION KIT

LEVER

THROTTLE CONTROL

BRAKE CALIPER

RACING KIT

BUTTON PANEL

LEVER GUARD

CLIP-ON

STREET RACING
REARSET

FUEL CAPS

STEERING NUT

CRASH PADS

Paddock STAND

MIRROR COVERS

REAR-VIEW MIRRORS

FOG LIGHTS KIT

HANDLEBARS
ACCESSORIES

HANDLEBARS

Applicazioni / Application list

Marca Brand	CC	Modello Model	Dal From	Al To	Codice Code	Tappo incluso Cap included	Novità New	Marca Brand	CC	Modello Model	Dal From	Al To	Codice Code	Tappo incluso Cap included	Novità New
Aprilia	250	Rs	1995	2003	TS003	Freno / Brake	N	Ducati	695	Monster 695	2007	2008	TS014	Freno / Brake	N
Aprilia	750	Dorsoduro 750	2008	2016	TS004	Freno e frizione / Brake and clutch	N	Ducati	696	Monster 696	2008	2015	TS006	Freno e frizione / Brake and clutch	N
Aprilia	750	Dorsoduro Factory 750	2010	2013	TS004	Freno e frizione / Brake and clutch	N	Ducati	696	Monster 696 Abs	2010	2014	TS006	Freno e frizione / Brake and clutch	N
Aprilia	750	Shiver 750	2007	2016	TS004	Freno e frizione / Brake and clutch	N	Ducati	696	Monster 696 Anniversary / Abs	2013	2013	TS006	Freno e frizione / Brake and clutch	N
Aprilia	750	Shiver 750 Gt	2009	2009	TS004	Freno e frizione / Brake and clutch	N	Ducati	748	748	1995	2001	TS003	Freno / Brake	N
Aprilia	850	Mana	2007	2011	TS004	Freno e frizione / Brake and clutch	N	Ducati	748	748 E	2001	2002	TS003	Freno / Brake	N
Aprilia	850	Mana Gt	2009	2016	TS004	Freno e frizione / Brake and clutch	N	Ducati	748	748 R	1999	1999	TS003	Freno / Brake	N
Aprilia	900	Dorsoduro	2017	2017	TS004	Freno e frizione / Brake and clutch	N	Ducati	748	748 R Single Seat	1998	2002	TS003	Freno / Brake	N
Aprilia	900	Dorsoduro Euro 4 Abs	2018	2018	TS004	Freno e frizione / Brake and clutch	N	Ducati	748	748 Rs	2000	2001	TS003	Freno / Brake	N
Aprilia	900	Shiver 900	2017	2018	TS004	Freno e frizione / Brake and clutch	N	Ducati	748	748 S	2000	2002	TS003	Freno / Brake	N
Aprilia	900	Shiver Euro 4 Abs Navi	2019	2019	TS004	Freno e frizione / Brake and clutch	N	Ducati	748	748 Sps	1998	1999	TS003	Freno / Brake	N
Aprilia	1000	Rsv	1998	1999	TS003	Freno / Brake	N	Ducati	750	Monster 750	1996	2002	TS007	Freno e frizione / Brake and clutch	N
Aprilia	1000	Rsv R	2000	2003	TS003	Freno / Brake	N	Ducati	750	Monster 750 Dark City	1999	1999	TS007	Freno e frizione / Brake and clutch	N
Aprilia	1000	Rsv R - Factory - Dream	2004	2008	TS003	Freno / Brake	N	Ducati	750	Supersport 750 S	2001	2002	TS007	Freno e frizione / Brake and clutch	N
Aprilia	1000	Rsv R Tuono	2002	2005	TS003	Freno / Brake	N	Ducati	750	Supersport 750 Ss	1999	2002	TS003	Freno / Brake	N
Aprilia	1000	Rsv Sp	1999	2000	TS003	Freno / Brake	N	Ducati	750	Supersport 750 Ss	1991	1997	TS007	Freno e frizione / Brake and clutch	N
Aprilia	1000	Rsv4	2009	2012	TS003	Freno / Brake	N	Ducati	796	Hypermotard 796	2010	2012	TS006	Freno e frizione / Brake and clutch	N
Aprilia	1000	Rsv4 Aprc R	2011	2012	TS003	Freno / Brake	N	Ducati	796	Monster 796	2011	2013	TS006	Freno e frizione / Brake and clutch	N
Aprilia	1000	Rsv4 Aprc R Abs	2013	2014	TS003	Freno / Brake	N	Ducati	796	Monster 796 Abs	2011	2014	TS006	Freno e frizione / Brake and clutch	N
Aprilia	1000	Rsv4 Factory	2009	2014	TS003	Freno / Brake	N	Ducati	796	Monster 796 Abs Corse Stripe	2014	2015	TS006	Freno e frizione / Brake and clutch	N
Aprilia	1000	Rsv4 R	2009	2010	TS003	Freno / Brake	N	Ducati	796	Monster 796 Abs Red Stripe C	2015	2015	TS006	Freno e frizione / Brake and clutch	N
Aprilia	1000	Rsv4 Racing Factory Abs	2018	2019	TS003	Freno / Brake	N	Ducati	796	Monster 796 Anniversary / Abs	2013	2013	TS006	Freno e frizione / Brake and clutch	N
Aprilia	1000	Rsv4 Racing Factory Le	2015	2017	TS003	Freno / Brake	N	Ducati	797	Monster 797	2017	2019	TS014	Freno / Brake	N
Aprilia	1000	Rsv4 Rr	2015	2019	TS003	Freno / Brake	N	Ducati	797	Monster 797 Plus	2017	2019	TS014	Freno / Brake	N
Aprilia	1000	SI Falco	2000	2003	TS003	Freno / Brake	N	Ducati	800	Monster 800	2003	2004	TS007	Freno e frizione / Brake and clutch	N
Aprilia	1000	Tuono R Factory	2006	2018	TS003	Freno / Brake	N	Ducati	800	Monster S2R 800	2005	2007	TS007	Freno e frizione / Brake and clutch	N
Aprilia	1000	Tuono V4 Factory Superpole Euro 4	2019	2019	TS003	Freno / Brake	N	Ducati	800	Monster S2R 800 Dark	2005	2006	TS007	Freno e frizione / Brake and clutch	N
Aprilia	1000	Tuono V4 R	2011	2014	TS003	Freno / Brake	N	Ducati	800	Scrambler Cafe Racer	2014	2020	TS003	Freno / Brake	N
Aprilia	1100	Tuono V4 Factory	2015	2017	TS003	Freno / Brake	N	Ducati	800	Supersport 800 S	2003	2003	TS007	Freno e frizione / Brake and clutch	N
Aprilia	1100	Tuono V4 Rf Abs	2018	2018	TS003	Freno / Brake	N	Ducati	800	Supersport 800 Ss	2004	2005	TS007	Freno e frizione / Brake and clutch	N
Aprilia	1100	Tuono V4 Rr	2015	2018	TS003	Freno / Brake	N	Ducati	821	Hypermotard 821	2013	2017	TS014	Freno / Brake	N
Aprilia	1200	Caponord	2013	2016	TS003	Freno / Brake	N	Ducati	821	Hypermotard Hyperstrada	2013	2015	TS014	Freno / Brake	N
Aprilia	1200	Caponord Carabinieri	2015	2015	TS003	Freno / Brake	N	Ducati	821	Hypermotard Sp	2013	2015	TS003	Freno / Brake	N
Aprilia	1200	Caponord Rally	2015	2016	TS003	Freno / Brake	N	Ducati	821	Monster 821	2015	2021	TS014	Freno / Brake	N
Aprilia	1200	Dorsoduro 1200	2010	2013	TS003	Freno / Brake	N	Ducati	821	Monster 821 Dark	2015	2021	TS014	Freno / Brake	N
Bmw	1000	S1000R	2012	2018	TS005	Freno / Brake	N	Ducati	821	Monster 821 Stealth	2019	2021	TS014	Freno / Brake	N
Bmw	1000	S1000RR	2009	2018	TS005	Freno / Brake	N	Ducati	821	Monster 821 Stripes	2015	2017	TS014	Freno / Brake	N
Cagiva	650	Raptor - V Raptor	2001	2005	TS005	Freno / Brake	N	Ducati	848	848	2008	2010	TS003	Freno / Brake	N
Cagiva	650	Raptor le	2000	2006	TS005	Freno / Brake	N	Ducati	848	848 Evo	2011	2013	TS003	Freno / Brake	N
Cagiva	1000	Raptor - V Raptor - X-Tra Raptor	2000	2005	TS005	Freno / Brake	N	Ducati	848	848 Evo Corse Se	2012	2013	TS003	Freno / Brake	N
Ducati	400	Monster 400	2007	2008	TS014	Freno / Brake	N	Ducati	848	848 Hayden	2010	2010	TS003	Freno / Brake	N
Ducati	400	Monster 400	1995	2006	TS007	Freno e frizione / Brake and clutch	N	Ducati	851	851	1991	1991	TS007	Freno e frizione / Brake and clutch	N
Ducati	400	Monster 400 Dark	2005	2005	TS007	Freno e frizione / Brake and clutch	N	Ducati	888	888 Sp5	1993	1993	TS003	Freno / Brake	N
Ducati	400	Supersport 400 Ss	1993	1997	TS007	Freno e frizione / Brake and clutch	N	Ducati	888	Suoperbike 888	1994	1995	TS003	Freno / Brake	N
Ducati	600	Monster 600	1993	2001	TS007	Freno e frizione / Brake and clutch	N	Ducati	899	899	2012	2016	TS003	Freno / Brake	N
Ducati	600	Monster 600 City	1999	1999	TS007	Freno e frizione / Brake and clutch	N	Ducati	899	Panigale 899	2014	2015	TS003	Freno / Brake	N
Ducati	600	Monster 600 Dark	1998	1999	TS007	Freno e frizione / Brake and clutch	N	Ducati	900	Monster 900	1993	1997	TS007	Freno e frizione / Brake and clutch	N
Ducati	600	Supersport 600 Ss	1991	1997	TS007	Freno e frizione / Brake and clutch	N	Ducati	900	Monster 900 (Club Italia)	1993	2002	TS003	Freno / Brake	N
Ducati	620	Monster 620	2002	2005	TS007	Freno e frizione / Brake and clutch	N	Ducati	900	Monster 900 City	1999	1999	TS003	Freno / Brake	N
Ducati	620	Monster 620 / 620 Dark	2006	2006	TS014	Freno / Brake	N	Ducati	900	Monster 900 Cromo	1998	1998	TS003	Freno / Brake	N
Ducati	620	Multistrada 620	2006	2006	TS007	Freno e frizione / Brake and clutch	N	Ducati	900	Monster 900 Dark City	1999	1999	TS003	Freno / Brake	N
Ducati	620	Multistrada 620 Dark	2006	2006	TS014	Freno / Brake	N	Ducati	900	Monster 900 S	1998	1998	TS003	Freno / Brake	N
Ducati	620	Supersport 620 S	2003	2003	TS007	Freno e frizione / Brake and clutch	N	Ducati	900	Sportclassic Mh900E	2001	2002	TS003	Freno / Brake	N

BRAKE/CLUTCH
MASTER CYLINDERS

ACCESSORIES
SPARE PARTS

CNC-WORKED FLUID
RESERVOIR

FULL CLUTCH

HYDRAULIC-CLUTCH
TRANFORMATION KIT

LEVER

THROTTLE CONTROL

BRAKE CALIPER

RACING KIT

BUTTON PANEL

LEVER GUARD

CLIP-ON

STREET RACING
REARSET

FUEL CAPS

STEERING NUT

CRASH PADS

PADDOCK STAND

MIRROR COVERS

REAR-VIEW MIRRORS

FOG LIGHTS KIT

HANDLEBARS
ACCESSORIES

HANDLEBARS

Marca Brand	CC	Modello Model	Dal From	Al To	Codice Code	Tappo incluso Cap included	Novità New	Marca Brand	CC	Modello Model	Dal From	Al To	Codice Code	Tappo incluso Cap included	Novità New
Ducati	900	Supersport 900 S	2002	2002	TS003	Freno / Brake	N	Ducati	1000	Sportclassic 1000S	2007	2009	TS003	Freno / Brake	N
Ducati	900	Supersport 900 Ss	1991	2002	TS003	Freno / Brake	N	Ducati	1000	Sportclassic Paul Smart	2006	2006	TS003	Freno / Brake	N
Ducati	900	Supersport 900 Ss Final Edition	1998	1998	TS003	Freno / Brake	N	Ducati	1000	Supersport 1000 Ss	2003	2006	TS003	Freno / Brake	N
Ducati	907	907 I.E.	1990	1993	TS007	Freno e frizione / Brake and clutch	N	Ducati	1098	1098	2007	2011	TS003	Freno / Brake	N
Ducati	916	916	1994	1997	TS003	Freno / Brake	N	Ducati	1098	1098 R	2008	2009	TS003	Freno / Brake	N
Ducati	916	916 Senna	1994	1998	TS003	Freno / Brake	N	Ducati	1098	1098 R Bayliss	2009	2009	TS003	Freno / Brake	N
Ducati	916	916 Sp	1994	1996	TS003	Freno / Brake	N	Ducati	1098	1098 S	2007	2008	TS003	Freno / Brake	N
Ducati	916	916 Sps	1997	1998	TS003	Freno / Brake	N	Ducati	1098	1098 S Tricolore	2007	2008	TS003	Freno / Brake	N
Ducati	916	Monster S4	2001	2002	TS003	Freno / Brake	N	Ducati	1100	Hypermotard 1100 / 1100 S	2008	2010	TS003	Freno / Brake	N
Ducati	916	Monster S4 Fogarty	2002	2002	TS003	Freno / Brake	N	Ducati	1100	Hypermotard 1100 Evo / Evo Sp	2010	2012	TS003	Freno / Brake	N
Ducati	936	Supersport 936 / 936 S	2017	2020	TS003	Freno / Brake	N	Ducati	1100	Monster 1100 / 1100 S	2009	2010	TS003	Freno / Brake	N
Ducati	939	Hypermotard 821 Low Seat	2015	2015	TS003	Freno / Brake	N	Ducati	1100	Monster 1100 Abs / S Abs	2010	2010	TS003	Freno / Brake	N
Ducati	939	Hypermotard 939	2012	2018	TS014	Freno / Brake	N	Ducati	1100	Monster 1100 Diesel	2013	2013	TS003	Freno / Brake	N
Ducati	939	Hypermotard 939 Sp / Sp U	2016	2018	TS003	Freno / Brake	N	Ducati	1100	Monster 1100 Evo Abs	2012	2013	TS003	Freno / Brake	N
Ducati	939	Hypermotard Hyperstrada 939	2016	2016	TS014	Freno / Brake	N	Ducati	1100	Monster 1100 Evo Anniversary	2013	2013	TS003	Freno / Brake	N
Ducati	944	Sport Touring St2	1997	1998	TS007	Freno e frizione / Brake and clutch	N	Ducati	1100	Panigale V4	2018	2020	TS003	Freno / Brake	N
Ducati	944	Sport Touring St2/St4	1999	2003	TS003	Freno / Brake	N	Ducati	1100	Panigale V4 S	2018	2020	TS003	Freno / Brake	N
Ducati	950	Multistrada 950	2017	2021	TS003	Freno / Brake	N	Ducati	1100	Panigale V4 S Corse	2019	2020	TS003	Freno / Brake	N
Ducati	950	Multistrada 950 RVE	2021	2021	TS003	Freno / Brake	N	Ducati	1100	Panigale V4 Speciale	2018	2019	TS003	Freno / Brake	N
Ducati	950	Multistrada 950 S	2019	2020	TS003	Freno / Brake	N	Ducati	1198	1198	2009	2011	TS003	Freno / Brake	N
Ducati	950	Multistrada 950 S / Sw / S Touring	2019	2020	TS003	Freno / Brake	N	Ducati	1198	1198 R	2010	2010	TS003	Freno / Brake	N
Ducati	950	Multistrada 950 S Sw	2019	2020	TS003	Freno / Brake	N	Ducati	1198	1198 S	2009	2010	TS003	Freno / Brake	N
Ducati	950	Multistrada 950 S Touring	2019	2020	TS003	Freno / Brake	N	Ducati	1198	1198 S Corse	2010	2010	TS003	Freno / Brake	N
Ducati	950	Multistrada 950 Sw	2018	2018	TS003	Freno / Brake	N	Ducati	1198	1198 Sp	2011	2011	TS003	Freno / Brake	N
Ducati	950	Multistrada 950 Touring	2017	2018	TS014	Freno / Brake	N	Ducati	1199	1199 Panigale	2012	2017	TS003	Freno / Brake	N
Ducati	959	959 Panigale Abs	2017	2018	TS003	Freno / Brake	N	Ducati	1199	1199 Panigale Abs / S Abs	2012	2014	TS003	Freno / Brake	N
Ducati	959	959 Panigale Corse / U	2018	2019	TS003	Freno / Brake	N	Ducati	1199	1199 Panigale R	2013	2014	TS003	Freno / Brake	N
Ducati	995	959 Panigale Corse	2018	2019	TS003	Freno / Brake	N	Ducati	1199	1199 Panigale S / S Tricolore	2012	2013	TS003	Freno / Brake	N
Ducati	996	996	1999	2001	TS003	Freno / Brake	N	Ducati	1199	1199 Panigale Superleggera	2014	2014	TS003	Freno / Brake	N
Ducati	996	993 Sps II	1999	1999	TS003	Freno / Brake	N	Ducati	1200	Monster 1200 / 1200S	2014	2021	TS003	Freno / Brake	N
Ducati	996	996 S / Rs / R II / R	2001	2001	TS003	Freno / Brake	N	Ducati	1200	Monster 1200 R	2016	2019	TS003	Freno / Brake	N
Ducati	996	996 Sps	1999	2000	TS003	Freno / Brake	N	Ducati	1200	Monster 1200 S Stripes	2015	2016	TS003	Freno / Brake	N
Ducati	996	996 Sps III	2000	2000	TS003	Freno / Brake	N	Ducati	1200	Multistrada	2010	2016	TS003	Freno / Brake	N
Ducati	996	Sport Touring St4S	2001	2003	TS003	Freno / Brake	N	Ducati	1200	Multistrada 1200 Abs	2010	2017	TS003	Freno / Brake	N
Ducati	996	Sport Touring St4S Abs	2003	2003	TS003	Freno / Brake	N	Ducati	1200	Multistrada 1200 Abs Sport Pack	2017	2018	TS003	Freno / Brake	N
Ducati	998	998	2002	2003	TS003	Freno / Brake	N	Ducati	1200	Multistrada 1200 Enduro / Enduro Pro	2018	2018	TS003	Freno / Brake	N
Ducati	998	998 Final Edition	2004	2004	TS003	Freno / Brake	N	Ducati	1200	Multistrada 1200 Enduro / Touring	2016	2018	TS003	Freno / Brake	N
Ducati	998	998 Matrix	2004	2004	TS003	Freno / Brake	N	Ducati	1200	Multistrada 1200 Enduro Pro	2018	2018	TS003	Freno / Brake	N
Ducati	998	998 R	2002	2002	TS003	Freno / Brake	N	Ducati	1200	Multistrada 1200 S	2010	2021	TS003	Freno / Brake	N
Ducati	998	998 Rs	2002	2003	TS003	Freno / Brake	N	Ducati	1200	Multistrada 1200 S Abs	2015	2017	TS003	Freno / Brake	N
Ducati	998	998 S Bayliss	2002	2002	TS003	Freno / Brake	N	Ducati	1200	Multistrada 1200 S D-Air	2016	2017	TS003	Freno / Brake	N
Ducati	998	998 S Bostrom	2002	2002	TS003	Freno / Brake	N	Ducati	1200	Multistrada 1200 S Gt	2013	2014	TS003	Freno / Brake	N
Ducati	998	Panigale V4 R	2019	2020	TS003	Freno / Brake	N	Ducati	1200	Multistrada 1200 S Pikes Peak	2012	2017	TS003	Freno / Brake	N
Ducati	999	999	2003	2006	TS003	Freno / Brake	N	Ducati	1200	Multistrada 1200 S Sport	2011	2012	TS003	Freno / Brake	N
Ducati	1000	Desmosedici Rr	2008	2008	TS003	Freno / Brake	N	Ducati	1200	Multistrada 1200 S Touring	2010	2017	TS003	Freno / Brake	N
Ducati	1000	Monster 1000	2003	2005	TS003	Freno / Brake	N	Ducati	1200	Multistrada 1200 S Touring D-Air	2014	2014	TS003	Freno / Brake	N
Ducati	1000	Monster 1000 S	2005	2005	TS003	Freno / Brake	N	Ducati	1200	Multistrada 1200 Touring	2015	2017	TS003	Freno / Brake	N
Ducati	1000	Monster S2R 1000	2006	2008	TS003	Freno / Brake	N	Ducati	1200	Multistrada 1260 Abs / S Abs / S D-Air	2019	2020	TS003	Freno / Brake	N
Ducati	1000	Monster S4R	2003	2008	TS003	Freno / Brake	N	Ducati	1200	Multistrada 1260 Touring / S Touring	2019	2020	TS003	Freno / Brake	N
Ducati	1000	Monster S4Rs	2006	2008	TS003	Freno / Brake	N	Ducati	1260	Multistrada 1260 Abs	2019	2020	TS003	Freno / Brake	N
Ducati	1000	Monster S4Rs Tricolore	2008	2008	TS003	Freno / Brake	N	Ducati	1260	Multistrada 1260 S Abs	2018	2020	TS003	Freno / Brake	N
Ducati	1000	Sportclassic 1000	2007	2008	TS003	Freno / Brake	N	Ducati	1260	Multistrada 1260 S D-Air	2018	2020	TS003	Freno / Brake	N
Ducati	1000	Sportclassic 1000 Single Seat	2006	2007	TS003	Freno / Brake	N	Ducati	1260	Multistrada 1260 S Pikes Peak	2018	2020	TS003	Freno / Brake	N

- BRAKE/CLUTCH MASTER CYLINDERS
- ACCESSORIES SPARE PARTS
- CNC-WORKED FLUID RESERVOIR
- FULL CLUTCH
- HYDRAULIC-CLUTCH TRANFORMATION KIT
- LEVER
- THROTTLE CONTROL
- BRAKE CALIPER
- RACING KIT
- BUTTON PANEL
- LEVER GUARD
- CLIP-ON
- STREET RACING REARSET
- FUEL CAPS
- STEERING NUT
- CRASH PADS
- PADDOCK STAND
- MIRROR COVERS
- REAR-VIEW MIRRORS
- FOG LIGHTS KIT
- HANDLEBARS ACCESSORIES
- HANDLEBARS

Marca Brand	CC	Modello Model	Dal From	Al To	Codice Code	Tappo incluso Cap included	Novità New	Marca Brand	CC	Modello Model	Dal From	Al To	Codice Code	Tappo incluso Cap included	Novità New
Ducati	1260	Multistrada 1260 S Touring	2019	2020	TS003	Freno / Brake	N	Kawasaki	1000	Ninja Zx-10R	2008	2015	TS005	Freno / Brake	
Ducati	1260	Multistrada 1260 Touring	2019	2020	TS003	Freno / Brake	N	Kawasaki	1000	Ninja Zx10R Abs	2004	2015	TS005	Freno / Brake	N
Ducati	1260	Multistrada Enduro Touring	2019	2020	TS003	Freno / Brake	N	Kawasaki	1000	Ninja Zx-10Rr	2017	2018	TS003	Freno / Brake	N
Ducati	1299	1299 Abs	2016	2017	TS003	Freno / Brake	N	Kawasaki	1000	Z1000	2020	2020	TS005	Freno / Brake	N
Ducati	1299	1299 R Final Edition	2018	2018	TS003	Freno / Brake	N	Kawasaki	1000	Z1000	2003	2009	TS005	Freno / Brake	N
Ducati	1299	1299 S 90° Anniversario	2000	2000	TS003	Freno / Brake	N	Kawasaki	1000	Z1000	2010	2016	TS008	Freno / Brake	N
Ducati	1299	1299 S Abs	2015	2017	TS003	Freno / Brake	N	Kawasaki	1000	Z1000 Abs	2007	2009	TS005	Freno / Brake	N
Ducati	1299	1299 Superleggera	2017	2017	TS003	Freno / Brake	N	Kawasaki	1000	Z1000 Abs	2010	2020	TS008	Freno / Brake	N
Ducati	1299	Panigale 1299	2012	2017	TS003	Freno / Brake	N	Kawasaki	1000	Z1000 R	2017	2020	TS008	Freno / Brake	N
Honda	600	Cbr600Rr	2007	2016	TS005	Freno / Brake		Kawasaki	1000	Z1000 Sx	2011	2019	TS005	Freno / Brake	N
Honda	1000	Cb1000R	2008	2017	TS005	Freno / Brake		Kawasaki	1000	Zx-10	1988	1990	TS005	Freno / Brake	N
Honda	1000	Cbr1000Rr	2006	2018	TS005	Freno / Brake		Kawasaki	1100	Gpz	1995	1997	TS005	Freno / Brake	N
Husqvarna	900	Nuda	2012	2015	TS003	Freno / Brake	N	Kawasaki	1100	Zr Zephyr	1992	1995	TS005	Freno / Brake	N
Kawasaki	250	Ninja 250R	2008	2012	TS005	Freno / Brake	N	Kawasaki	1100	Zrx	1997	1999	TS005	Freno / Brake	N
Kawasaki	400	Zxr 400 R	1991	1999	TS005	Freno / Brake	N	Kawasaki	1100	Zzr	1990	1999	TS005	Freno / Brake	N
Kawasaki	600	Ninja Zx-6R	1998	2017	TS005	Freno / Brake		Kawasaki	1200	Zrx	2001	2004	TS005	Freno / Brake	N
Kawasaki	600	Ninja Zx6Rr	2003	2005	TS005	Freno / Brake	N	Kawasaki	1200	Zrx R	2001	2006	TS005	Freno / Brake	N
Kawasaki	600	Zzr 600	1991	2006	TS005	Freno / Brake	N	Kawasaki	1200	Zrx S	2001	2004	TS005	Freno / Brake	N
Kawasaki	636	Zx6R 636	2019	2020	TS005	Freno / Brake	N	Kawasaki	1200	Zzr	2002	2007	TS005	Freno / Brake	N
Kawasaki	636	Zx6R 636 A1P	2002	2002	TS005	Freno / Brake	N	Kawasaki	1400	Gtr	2008	2014	TS008	Freno / Brake	N
Kawasaki	636	Zx6R 636 Abs	2013	2017	TS005	Freno / Brake	N	Kawasaki	1400	Gtr Abs	2015	2018	TS008	Freno / Brake	N
Kawasaki	650	Er-6 F / Er-6 N	2006	2016	TS005	Freno / Brake	N	Kawasaki	1400	Gtr Abs	2020	2020	TS008	Freno / Brake	N
Kawasaki	650	Kle Versys	2007	2020	TS005	Freno / Brake	N	Kawasaki	1400	Zzr	2006	2007	TS005	Freno / Brake	N
Kawasaki	750	Gpx R	1987	1989	TS005	Freno / Brake	N	Kawasaki	1400	Zzr Abs	2006	2020	TS005	Freno / Brake	N
Kawasaki	750	Ninja Zx-7 R	1996	2002	TS005	Freno / Brake	N	Kawasaki	1500	Vn Classic	1996	2002	TS005	Freno / Brake	N
Kawasaki	750	Ninja Zx-7 Rr	1996	1998	TS005	Freno / Brake	N	Kawasaki	1500	Vn Classic Tourer	1998	2003	TS005	Freno / Brake	N
Kawasaki	750	Z750 / Z750 Abs	2007	2012	TS005	Freno / Brake		Kawasaki	1500	Vn Drifter	1999	2000	TS005	Freno / Brake	N
Kawasaki	750	Z750 R / Z750 R Abs	2011	2012	TS008	Freno / Brake	N	Kawasaki	1500	Vn Main Streak	2002	2003	TS005	Freno / Brake	N
Kawasaki	750	Z750 S	2005	2006	TS005	Freno / Brake	N	Kawasaki	1600	Vn Classic	2003	2006	TS005	Freno / Brake	N
Kawasaki	750	Zr Zephyr	1991	1994	TS005	Freno / Brake	N	Kawasaki	1600	Vn Classic Tourer	2005	2006	TS005	Freno / Brake	N
Kawasaki	750	Zr-7	1999	2003	TS005	Freno / Brake	N	Kawasaki	1600	Vn Mean Streak	2004	2007	TS005	Freno / Brake	N
Kawasaki	750	Zr-7 S	2001	2003	TS005	Freno / Brake	N	Kawasaki	1700	Vn Classic	2009	2014	TS005	Freno / Brake	N
Kawasaki	750	Zxr / Zxr R	1990	1995	TS005	Freno / Brake	N	Kawasaki	1700	Vn Classic Tourer	2009	2014	TS005	Freno / Brake	N
Kawasaki	750	Zxr Stinger	1989	1990	TS005	Freno / Brake	N	Kawasaki	1700	Vn Voyager Abs	2009	2012	TS005	Freno / Brake	N
Kawasaki	800	Vn Drifter	1999	2001	TS005	Freno / Brake	N	Kawasaki	1700	Vn Voyager Custom Abs	2011	2016	TS005	Freno / Brake	N
Kawasaki	900	Ninja Zx9 R	1998	2003	TS005	Freno / Brake	N	Kawasaki	1700	Vn Vulcan Voyager Abs	2013	2016	TS005	Freno / Brake	N
Kawasaki	900	Ninja Zx9 R Euro 2	2002	2003	TS005	Freno / Brake	N	Kawasaki	2000	Vn	2004	2006	TS005	Freno / Brake	N
Kawasaki	900	Vn Classic	2006	2014	TS005	Freno / Brake	N	Kawasaki	2000	Vn Classic	2008	2010	TS005	Freno / Brake	N
Kawasaki	900	Vn Custom	2007	2011	TS005	Freno / Brake	N	Ktm	690	690 Sm / Smr	2007	2012	TS003	Freno / Brake	N
Kawasaki	900	Vn Vulcan Classic	2015	2016	TS005	Freno / Brake	N	Ktm	990	Super Duke	2007	2012	TS003	Freno / Brake	
Kawasaki	900	Vn Vulcan Classic	2019	2019	TS005	Freno / Brake	N	Ktm	1190	Rc8	2008	2012	TS005	Freno / Brake	
Kawasaki	900	Vn Vulcan Custom	2012	2016	TS005	Freno / Brake	N	Ktm	1290	Superduke 1290	2014	2018	TS003	Freno / Brake	N
Kawasaki	900	Vn Vulcan Custom	2019	2020	TS005	Freno / Brake	N	Mv Agusta	675	F3 675	2012	2019	TS005	Freno / Brake	N
Kawasaki	900	Z900 Rs	2018	2020	TS005	Freno / Brake	N	Mv Agusta	800	F3 800	2012	2019	TS005	Freno / Brake	N
Kawasaki	900	Z900 Rs Cafe	2018	2020	TS005	Freno / Brake	N	Mv Agusta	998	F4	2014	2017	TS003	Freno / Brake	N
Kawasaki	1000	Gpz Rx	1986	1988	TS005	Freno / Brake	N	Suzuki	125	Rg 125 F	1992	1994	TS005	Freno / Brake	N
Kawasaki	1000	Gtr	1996	1997	TS005	Freno / Brake	N	Suzuki	200	Rv 200 Van Van	2016	2016	TS009	Freno / Brake	N
Kawasaki	1000	Gtr	2003	2003	TS005	Freno / Brake	N	Suzuki	250	DI 1000 V-Strom	2002	2016	TS009	Freno / Brake	N
Kawasaki	1000	Klz Versys / Se	2019	2020	TS005	Freno / Brake	N	Suzuki	250	DI 250 V-Strom	2018	2019	TS009	Freno / Brake	N
Kawasaki	1000	Ninja 1000sx	2020	2020	TS005	Freno / Brake	N	Suzuki	250	Gw250F Inazuma	2015	2017	TS009	Freno / Brake	N
Kawasaki	1000	Ninja H2 Sx / Se / Se+	2018	2020	TS005	Freno / Brake	N	Suzuki	250	Rgv 250	1989	1996	TS005	Freno / Brake	N
Kawasaki	1000	Ninja H2R	2015	2017	TS003	Freno / Brake	N	Suzuki	600	Gsr 600 K6-LO	2006	2012	TS009	Freno / Brake	
Kawasaki	1000	Ninja Zx-10R	2016	2019	TS003	Freno / Brake	N	Suzuki	600	Gsx-R 600	1997	2017	TS005	Freno / Brake	

BRAKE/CLUTCH
 MASTER CYLINDERS
 ACCESSORIES
 SPARE PARTS
 CNC-WORKED FLUID
 RESERVOIR
 FULL CLUTCH
 HYDRAULIC-CLUTCH
 TRANFORMATION KIT
 LEVER
 THROTTLE CONTROL
 BRAKE CALIPER
 RACING KIT
 BUTTON PANEL
 LEVER GUARD
 CLIP-ON
 STREET RACING
 REARSET
 FUEL CAPS
 STEERING NUT
 CRASH PADS
 PADDOCK STAND
 MIRROR COVERS
 REAR-VIEW MIRRORS
 FOG LIGHTS KIT
 HANDLEBARS
 ACCESSORIES
 HANDLEBARS

Marca Brand	CC	Modello Model	Dal From	Al To	Codice Code	Tappo incluso Cap included	Novità New	Marca Brand	CC	Modello Model	Dal From	Al To	Codice Code	Tappo incluso Cap included	Novità New
Suzuki	650	An650 Burgman	2003	2016	TS009	Freno / Brake	N	Yamaha	700	Mt-07 Mc Moto Cage	2014	2014	TS011	Freno / Brake	
Suzuki	650	An650Z Burgman	2018	2018	TS009	Freno / Brake	N	Yamaha	700	Mtm 690	2016	2019	TS011	Freno / Brake	N
Suzuki	650	DI 650 V-Strom	2004	2016	TS009	Freno / Brake	N	Yamaha	700	Mtt 690 Tracer	2016	2018	TS011	Freno / Brake	N
Suzuki	650	Gsf 650 Bandit K5-K9 L0-L2	2005	2012	TS009	Freno / Brake	N	Yamaha	700	Xsr700	2016	2018	TS011	Freno / Brake	N
Suzuki	650	Gsx 650 F	2008	2012	TS009	Freno / Brake	N	Yamaha	700	Xsr900	2016	2019	TS011	Freno / Brake	N
Suzuki	650	Sfv 650 Gladius K9-L0 L1-L5	2009	2015	TS009	Freno / Brake	N	Yamaha	800	Fz8 N-Na-S-Sa	2010	2015	TS011	Freno / Brake	N
Suzuki	650	Sv 650 K3-K7/K8-L0	2003	2010	TS009	Freno / Brake	N	Yamaha	850	Mt-09	2013	2019	TS011	Freno / Brake	N
Suzuki	650	Sv650 A L7	2016	2018	TS009	Freno / Brake	N	Yamaha	850	Mt-09 Tracer	2013	2019	TS011	Freno / Brake	N
Suzuki	650	Sv650 S L5	2015	2015	TS005	Freno / Brake	N	Yamaha	850	Mt-09 Tracer Gt	2018	2018	TS011	Freno / Brake	N
Suzuki	650	Sv650 X-L0	1999	2010	TS005	Freno / Brake	N	Yamaha	850	Mtx 850 Niken	2018	2018	TS005	Freno / Brake	N
Suzuki	750	Gsr 750 L1-L6	2011	2016	TS009	Freno / Brake	N	Yamaha	850	Mtx 850 Nken Gt / Tracer Gt	2019	2019	TS011	Freno / Brake	N
Suzuki	750	Gsx-R 750	1988	2017	TS005	Freno / Brake	N	Yamaha	900	Tdm 900	2002	2010	TS011	Freno / Brake	N
Suzuki	750	Gsx-S 750	2017	2019	TS009	Freno / Brake	N	Yamaha	900	Tdm 900 Abs	2002	2010	TS011	Freno / Brake	N
Suzuki	1000	Gsx-R 1000	2005	2019	TS005	Freno / Brake	N	Yamaha	950	Scr 950	2017	2017	TS011	Freno / Brake	N
Suzuki	1000	Sv 1000	2003	2007	TS009	Freno / Brake	N	Yamaha	950	Xv 950	2014	2017	TS010	Freno e frizione / Brake and clutch	N
Suzuki	1000	Sv 1000 S	2003	2007	TS005	Freno / Brake	N	Yamaha	950	Xv950 Racer	2015	2016	TS011	Freno / Brake	N
Suzuki	1000	Ti1000 R	1998	2000	TS005	Freno / Brake	N	Yamaha	1000	Fz1	2006	2015	TS011	Freno / Brake	N
Suzuki	1000	Ti1000 S	1997	2001	TS005	Freno / Brake	N	Yamaha	1000	Fz1 Fazer	2006	2012	TS011	Freno / Brake	N
Suzuki	1200	Gsf 1200 Bandit K1-K6	2006	2006	TS009	Freno / Brake	N	Yamaha	1000	Fz1 Fazer Abs	2007	2012	TS011	Freno / Brake	N
Suzuki	1250	Gsf 1250 Bandit K7/L0-L6	2010	2016	TS009	Freno / Brake	N	Yamaha	1000	Mt-10	2016	2019	TS011	Freno / Brake	N
Suzuki	1250	Gsx 1250 Fa	2010	2016	TS009	Freno / Brake	N	Yamaha	1000	Yzf R1 Sp	2006	2006	TS005	Freno / Brake	N
Suzuki	1300	Gsz1300 Hayabusa	2008	2017	TS009	Freno / Brake	N	Yamaha	1000	Yzf-R1	2004	2017	TS005	Freno / Brake	N
Suzuki	1400	Gsx 1400	2002	2007	TS009	Freno / Brake	N	Yamaha	1100	Bt 1100 Bulldog	2005	2006	TS011	Freno / Brake	N
Triumph	675	Daytona 675 / 675 R	2007	2016	TS005	Freno / Brake	N	Yamaha	1200	Xt1200 Z Super Tenere	2010	2019	TS011	Freno / Brake	N
Triumph	675	Streettriple	2007	2012	TS005	Freno / Brake	N	Yamaha	1200	Xt1200 Ze Super Tenere	2014	2019	TS011	Freno / Brake	N
Triumph	1050	Speed Triple	2011	2018	TS003	Freno / Brake	N	Yamaha	1300	Fjr 1300	2003	2018	TS011	Freno / Brake	N
Yamaha	400	Yp 400 Majesty / Majesty Abs	2009	2011	TS010	Freno e frizione / Brake and clutch	N	Yamaha	1300	Xjr1300	2004	2013	TS011	Freno / Brake	N
Yamaha	500	T-Max 500	2008	2012	TS010	Freno e frizione / Brake and clutch	N	Yamaha	1300	Xjr1300C	2015	2016	TS011	Freno / Brake	N
Yamaha	500	T-Max 500 Abs	2008	2011	TS010	Freno e frizione / Brake and clutch	N	Yamaha	1300	Xvs 1300 Custom	2014	2016	TS010	Freno e frizione / Brake and clutch	N
Yamaha	500	T-Max 500 Abs Sv	2010	2011	TS010	Freno e frizione / Brake and clutch	N	Yamaha	1300	Xvs 1300 Midnight Star	2011	2016	TS010	Freno e frizione / Brake and clutch	N
Yamaha	500	T-Max White Max	2010	2010	TS010	Freno e frizione / Brake and clutch	N	Yamaha	1700	Mt-01	2005	2006	TS005	Freno / Brake	N
Yamaha	530	T-Max 530	2001	2018	TS010	Freno e frizione / Brake and clutch	N								
Yamaha	530	T-Max 530 Abs	2012	2016	TS010	Freno e frizione / Brake and clutch	N								
Yamaha	530	T-Max Sp	2015	2015	TS010	Freno e frizione / Brake and clutch	N								
Yamaha	530	T-Max Sp Abs	2015	2016	TS010	Freno e frizione / Brake and clutch	N								
Yamaha	530	T-Max Sx / Dx	2017	2019	TS010	Freno e frizione / Brake and clutch	N								
Yamaha	600	Fz6	2004	2007	TS011	Freno / Brake	N								
Yamaha	600	Fz6 Fazer	2004	2007	TS011	Freno / Brake	N								
Yamaha	600	Fz6 Fazer Abs	2006	2007	TS011	Freno / Brake	N								
Yamaha	600	Fz6 Fazer S2	2007	2008	TS011	Freno / Brake	N								
Yamaha	600	Fz6 Fazer S2 Abs	2008	2008	TS011	Freno / Brake	N								
Yamaha	600	Fz6 Ns	2005	2006	TS011	Freno / Brake	N								
Yamaha	600	Fz6 S2	2007	2008	TS011	Freno / Brake	N								
Yamaha	600	Xj6	2008	2015	TS011	Freno / Brake	N								
Yamaha	600	Xj6 Diversion / Diversion Abs	2009	2015	TS011	Freno / Brake	N								
Yamaha	600	Yzf R46	2005	2005	TS005	Freno / Brake	N								
Yamaha	600	Yzf R6 & Limited Edition 07	2006	2006	TS005	Freno / Brake	N								
Yamaha	600	Yzf R6 50Th	2012	2012	TS005	Freno / Brake	N								
Yamaha	600	Yzf-R6	2003	2018	TS005	Freno / Brake	N								
Yamaha	660	Mt-03	2006	2013	TS011	Freno / Brake	N								
Yamaha	660	Xt660 Z Tenere	2008	2015	TS011	Freno / Brake	N								
Yamaha	660	Xt660 Za Tenere	2011	2015	TS011	Freno / Brake	N								
Yamaha	700	Mt-07	2014	2019	TS011	Freno / Brake	N								

- BRAKE/CLUTCH MASTER CYLINDERS
- ACCESSORIES SPARE PARTS
- CNC-WORKED FLUID RESERVOIR
- FULL CLUTCH
- HYDRAULIC-CLUTCH TRANFORMATION KIT
- LEVER
- THROTTLE CONTROL
- BRAKE CALIPER
- RACING KIT
- BUTTON PANEL
- LEVER GUARD
- CLIP-ON
- STREET RACING REARSET
- FUEL CAPS
- STEERING NUT
- CRASH PADS
- PADDOCK STAND
- MIRROR COVERS
- REAR-VIEW MIRRORS
- FOG LIGHTS KIT
- HANDLEBARS ACCESSORIES
- HANDLEBARS

COPERCHI POMPE FRIZIONE

CLUTCH MASTER CYLINDER COVER



Colori disponibili
Available colours

N ●
nero - black

O ●
arancione
orange

Y ●
oro - gold

B ●
blu - blue

R ●
rosso - red

S ●
argento - silver

- BRAKE/CLUTCH MASTER CYLINDERS
- ACCESSORIES SPARE PARTS
- CNC-WORKED FLUID RESERVOIR
- FULL CLUTCH
- HYDRAULIC-CLUTCH TRANSFORMATION KIT
- LEVER
- THROTTLE CONTROL
- BRAKE CALIPER
- RACING KIT
- BUTTON PANEL
- LEVER GUARD
- CLIP-ON
- STREET RACING REARSET
- FUEL CAPS
- STEERING NUT
- CRASH PADS
- Paddock STAND
- MIRROR COVERS
- REAR-VIEW MIRRORS
- FOG LIGHTS KIT
- HANDLEBARS ACCESSORIES
- HANDLEBARS

Applicazioni / Application list

Marca Brand	CC	Modello Model	Dal From	Al To	Codice coperchio Cover code	Novità New	Marca Brand	CC	Modello Model	Dal From	Al To	Codice coperchio Cover code	Novità New
APRILIA	1000	RSV	1998	1999	FP007	N	DUCATI	900	MONSTER 900	1998	2002	FP007	N
APRILIA	1000	SL FALCO	2000	2003	FP007	N	DUCATI	900	SUPERSPORT 900 S	2002	2002	FP007	N
APRILIA	1000	RSV, RSV R	2000	2003	FP007	N	DUCATI	900	SPORTCLASSIC MH900E	2001	2002	FP007	N
APRILIA	1000	RSV R TUONO	2002	2005	FP007	N	DUCATI	916	916	1994	1997	FP007	N
APRILIA	1000	RSV R - FACTORY - DREAM	2004	2008	FP007	N	DUCATI	916	916 SPS	1997	1998	FP007	N
APRILIA	1000	TUONO R-FACTORY	2006	2009	FP007	N	DUCATI	916	196 SENNA	1994	1998	FP007	N
APRILIA	1000	CAPONORD RALLY	2015	2016	FP007	N	DUCATI	916	916 R	1997	1998	FP007	N
APRILIA	1200	DORSODURO	2009	2016	FP007	N	DUCATI	916	MONSTER S4 FOGARTY	2002	2002	FP007	N
APRILIA	1200	CAPONORD	2013	2016	FP007	N	DUCATI	916	MONSTER S4	2001	2002	FP007	N
BMW	1200	R 1200 GS	2013	2016	FP015	N	DUCATI	916	SPORT TOURING ST4	1999	2003	FP007	N
BMW	1200	R NINE T	2014	2017	FP015	N	DUCATI	937	MULTISTRADA 950 S TOURING	2019	2020	FP007	N
BMW	1200	R NINE T SCRAMBLER	2016	2017	FP015	N	DUCATI	937	MULTISTRADA 950 S TOURING	2019	2020	FP007	N
BMW	1200	R NINE-T PURE	2016	2018	FP015	N	DUCATI	937	MULTISTRADA 950 S	2019	2020	FP007	N
BMW	1200	R NINE-T URBAN	2016	2018	FP015	N	DUCATI	937	MULTISTRADA 950	2019	2020	FP007	N
BMW	1200	R NINE-T RACER	2016	2018	FP015	N	DUCATI	950	HYPERMOTARD 950	2019	2019	FP007	N
DUCATI	696	MONSTER 696	2008	2015	FP011	N	DUCATI	959	PANIGALE CORSE U	2018	2019	FP007	N
DUCATI	696	MONSTER 696 ANNIVERSARY	2013	2013	FP011	N	DUCATI	959	PANIGALE CORSE	2018	2019	FP007	N
DUCATI	696	MONSTER 696 ABS ANNIVERSARY	2013	2013	FP011	N	DUCATI	959	PANIGALE ABS	2017	2019	FP007	N
DUCATI	696	MONSTER 696 ABS	2010	2014	FP011	N	DUCATI	994	SPORT TOURING ST2	1999	2003	FP007	N
DUCATI	748	748 SPS	1998	1999	FP007	N	DUCATI	996	996 SPS II	1999	1999	FP007	N
DUCATI	748	748 R	1999	1999	FP007	N	DUCATI	996	996 SPS III	2000	2000	FP007	N
DUCATI	748	748	1995	2001	FP007	N	DUCATI	996	996 SPS	1999	2000	FP007	N
DUCATI	748	748 RS	2000	2001	FP007	N	DUCATI	996	996	1999	2001	FP007	N
DUCATI	748	748 S	2000	2002	FP007	N	DUCATI	996	996 S	2001	2001	FP007	N
DUCATI	748	748 R SINGLE SEAT	1998	2002	FP007	N	DUCATI	996	996 RS	2000	2001	FP007	N
DUCATI	748	748 E	2001	2002	FP007	N	DUCATI	996	996 R II	2001	2001	FP007	N
DUCATI	750	SUPERSPORT 750 SS	1999	2002	FP007	N	DUCATI	996	996 R	1999	2001	FP007	N
DUCATI	795	MONSTER 795 ABS RED STRIPE C	2015	2015	FP011	N	DUCATI	996	SPORT TOURING ST4 S ABS	2003	2003	FP007	N
DUCATI	795	MONSTER 795 ABS CORSE STRIPE	2014	2015	FP011	N	DUCATI	996	SPORT TOURING ST4 S	2001	2003	FP007	N
DUCATI	796	MONSTER 796	2008	2015	FP011	N	DUCATI	996	SPORT TOURING ST4 S ABS	2004	2005	FP012	N
DUCATI	796	MONSTER 796 ANNIVERSARY	2013	2013	FP011	N	DUCATI	996	SPORT TOURING ST4 S	2004	2005	FP012	N
DUCATI	796	MONSTER 796 ABS ANNIVERSARY	2013	2013	FP011	N	DUCATI	998	998 S BOSTROM	2002	2002	FP007	N
DUCATI	796	MONSTER 796 ABS	2011	2013	FP011	N	DUCATI	998	998 S BAYLISS	2002	2002	FP007	N
DUCATI	796	HYPERMOTARD 796	2010	2012	FP011	N	DUCATI	998	998 R	2002	2002	FP007	N
DUCATI	800	SUPERSPORT 800 SS	2003	2003	FP007	N	DUCATI	998	998	2002	2003	FP007	N
DUCATI	800	SCRAMBLER CAFE RACER	2019	2020	FP007	N	DUCATI	998	998 RS	2002	2003	FP007	N
DUCATI	848	848 HAYDEN	2010	2010	FP007	N	DUCATI	998	998 MATRIX SINGLE-SE	2004	2004	FP007	N
DUCATI	848	848 EVO CORSE SE	2012	2013	FP007	N	DUCATI	998	998 MATRIX	2004	2004	FP007	N
DUCATI	848	848 EVO	2011	2013	FP007	N	DUCATI	998	998 FINAL ED.	2004	2004	FP007	N
DUCATI	848	STREETFIGHTER 848	2009	2016	FP012	N	DUCATI	998	998 FINAL ED. SINGLE	2004	2004	FP007	N
DUCATI	850	848	2007	2011	FP007	N	DUCATI	998	PANIGALE V4 R	2019	2019	FP007	N
DUCATI	851	851	1991	1992	FP007	N	DUCATI	1000	MONSTER 1000	2003	2003	FP007	N
DUCATI	888	888 SP5	1993	1993	FP007	N	DUCATI	1000	MONSTER 1000 S	2005	2005	FP007	N
DUCATI	888	888	1994	1995	FP007	N	DUCATI	1000	SUPERSPORT 1000 SS	2003	2006	FP007	N
DUCATI	899	PANIGALE ABS	2014	2015	FP007	N	DUCATI	1000	SPORTCLASSIC PAUL SMART	2006	2006	FP007	N
DUCATI	900	MONSTER 900 CLUB ITALIA	1993	1997	FP007	N	DUCATI	1000	SPORTCLASSIC SPORT 1000 SINGLE SEAT	2006	2007	FP007	N
DUCATI	900	SUPERSPORT 900SS FINAL ED.	1998	1998	FP007	N	DUCATI	1000	MONSTER S4R	2003	2008	FP007	N
DUCATI	900	MONSTER 900 S	1998	1998	FP007	N	DUCATI	1000	SPORTCLASSIC SPORT 1000	2007	2008	FP007	N
DUCATI	900	MONSTER 900 CROMO	1998	1998	FP007	N	DUCATI	1000	MONSTER S4RS	2006	2008	FP007	N
DUCATI	900	MONSTER 900 DARK CITY	1999	1999	FP007	N	DUCATI	1000	MONSTER S4RS TRICOLORE	2008	2008	FP007	N
DUCATI	900	MONSTER 900 CITY	1999	1999	FP007	N	DUCATI	1000	MONSTER S2R 1000	2006	2008	FP007	N
DUCATI	900	SUPERSPORT 900 SS	1991	2002	FP007	N	DUCATI	1000	DESMOSEDICI RR	2008	2008	FP007	N

- BRAKE/CLUTCH MASTER CYLINDERS
- ACCESSORIES SPARE PARTS
- CNC-WORKED FLUID RESERVOIR
- FULL CLUTCH
- HYDRAULIC-CLUTCH TRANFORMATION KIT
- LEVER
- THROTTLE CONTROL
- BRAKE CALIPER
- RACING KIT
- BUTTON PANEL
- LEVER GUARD
- CLIP-ON
- STREET RACING REARSET
- FUEL CAPS
- STEERING NUT
- CRASH PADS
- PADDOCK STAND
- MIRROR COVERS
- REAR-VIEW MIRRORS
- FOG LIGHTS KIT
- HANDLEBARS ACCESSORIES
- HANDLEBARS

Marca Brand	CC	Modello Model	Dal From	Al To	Codice coperchio Cover code	Novità New	Marca Brand	CC	Modello Model	Dal From	Al To	Codice coperchio Cover code	Novità New
DUCATI	1000	SPORTCLASSIC 1000 S	2007	2009	FP007	N	DUCATI	1200	MULTISTRADA 1200 S D-AIR	2016	2017	FP007	N
DUCATI	1000	SPORTCLASSIC GT1000	2007	2010	FP012	N	DUCATI	1200	MULTISTRADA 1200 S ABS	2015	2017	FP007	N
DUCATI	1000	SPORTCLASSIC GT1000 TOURING	2009	2009	FP012	N	DUCATI	1200	MULTISTRADA 1200 ABS	2010	2017	FP007	N
DUCATI	1000	SPORT TOURING ST3	2004	2007	FP012	N	DUCATI	1200	MULTISTRADA 1200 ENDURO	2016	2018	FP007	N
DUCATI	1000	SPORT TOURING ST3 ABS	2006	2007	FP012	N	DUCATI	1200	MULTISTRADA 1200 ENDURO TOURING	2016	2018	FP007	N
DUCATI	1000	MULTISTRADA 1000	2003	2006	FP012	N	DUCATI	1200	MULTISTRADA 1200 PRO	2018	2018	FP007	N
DUCATI	1000	MULTISTRADA 1000 S	2005	2006	FP012	N	DUCATI	1200	MULTISTRADA 1200 ABS SPORT PACK	2017	2018	FP007	N
DUCATI	1100	1098 S	2007	2008	FP007	N	DUCATI	1200	MONSTER 1200 R	2016	2019	FP007	N
DUCATI	1100	1098 S TRICOLORE	2007	2008	FP007	N	DUCATI	1200	MONSTER 1200	2014	2020	FP007	N
DUCATI	1100	1098 R	2008	2009	FP007	N	DUCATI	1200	MONSTER 1200 S	2014	2020	FP007	N
DUCATI	1100	1098 R BAYLISS	2009	2009	FP007	N	DUCATI	1260	MULTISTRADA 1260 TOURING	2018	2020	FP007	N
DUCATI	1100	HYPERMOTARD 1100	2007	2009	FP007	N	DUCATI	1260	MULTISTRADA 1260 S TOURING	2018	2020	FP007	N
DUCATI	1100	HYPERMOTARD 1100 S	2008	2009	FP007	N	DUCATI	1260	MULTISTRADA 1260 S PIKES PEAK	2018	2020	FP007	N
DUCATI	1100	MONSTER 1100	2009	2010	FP007	N	DUCATI	1260	MULTISTRADA 1260 S D-AIR	2018	2020	FP007	N
DUCATI	1100	MONSTER 1100 S	2009	2010	FP007	N	DUCATI	1260	MULTISTRADA 1260 S ABS	2018	2020	FP007	N
DUCATI	1100	MONSTER 1100 S ABS	2010	2010	FP007	N	DUCATI	1260	MULTISTRADA 1260 ENDURO TOURING	2019	2020	FP007	N
DUCATI	1100	MONSTER 1100 ABS	2010	2010	FP007	N	DUCATI	1260	MULTISTRADA 1260 ABS	2018	2020	FP007	N
DUCATI	1100	1098	2007	2011	FP007	N	DUCATI	1299	1299 S 90° ANNIVERSARIO	2000	2000	FP007	N
DUCATI	1100	HYPERMOTARD 1100 EVO	2010	2012	FP007	N	DUCATI	1299	1299S ABS	2015	2017	FP007	N
DUCATI	1100	MONSTER 1100 EVO ANNIVERSARY	2013	2013	FP007	N	DUCATI	1299	1299 SUPERLEGGERA	2017	2017	FP007	N
DUCATI	1100	MONSTER 1100 EVO ABS	2012	2013	FP007	N	DUCATI	1299	1299 ABS	2015	2017	FP007	N
DUCATI	1100	MONSTER 1100 DIESEL	2013	2013	FP007	N	DUCATI	1299	1299R FINAL EDITION	2018	2018	FP007	N
DUCATI	1100	PANIGALE V4	2018	2019	FP007	N	HONDA	1000	CB1000 R	2008	2017	FP008	
DUCATI	1100	PANIGALE V4 SPECIALE	2018	2019	FP007	N	HONDA	1000	CBR1000 RR	2008	2017	FP008	
DUCATI	1100	PANIGALE V4 S	2018	2019	FP007	N	KTM	690	690 SM	2007	2010	FP007	
DUCATI	1100	STREETFIGHTER 1100	2009	2016	FP012	N	KTM	690	690 SMR	2007	2010	FP007	
DUCATI	1100	STREETFIGHTER S 1100	2010	2013	FP012	N	KTM	990	SUPERDUKE 990	2007	2010	FP007	
DUCATI	1100	MULTISTRADA 1100	2007	2009	FP012	N	MV AGUSTA	750	F4	1999	2003	FP013	N
DUCATI	1100	MULTISTRADA 1100 S	2007	2009	FP012	N	MV AGUSTA	750	BRUTALE	2003	2005	FP013	N
DUCATI	1200	1200 S 25° ANNIVERSARIO	2000	2000	FP007	N	MV AGUSTA	900	BRUTALE 989R - 1078 RR	2008	2008	FP013	N
DUCATI	1200	1198 S	2009	2010	FP007	N	MV AGUSTA	910	BRUTALE	2005	2017	FP013	N
DUCATI	1200	1198 S CORSE	2010	2010	FP007	N	MV AGUSTA	1000	F4	2000	2009	FP013	N
DUCATI	1200	1198 R	2010	2010	FP007	N	MV AGUSTA	1000	F4 VELTRO STRADA	2008	2008	FP013	N
DUCATI	1200	MULTISTRADA 1200 S ABS	2010	2010	FP007	N	MV AGUSTA	1000	F4 R	2006	2007	FP013	N
DUCATI	1200	1198	2007	2011	FP007	N	MV AGUSTA	1000	F4 1000 312R - 1078 312RR	2007	2008	FP013	N
DUCATI	1200	MULTISTRADA 1200	2010	2012	FP007	N	MV AGUSTA	1000	F4	2014	2017	FP014	N
DUCATI	1200	MULTISTRADA 1200 S SPORT	2011	2012	FP007	N	MV AGUSTA	1000	F4 VELTRO PISTA	2008	2008	FP014	N
DUCATI	1200	1199 PANIGALE	2012	2013	FP007	N	MV AGUSTA	1000	F4 S - R - RR - FRECCIE TRICOCLORE	2010	2012	FP014	N
DUCATI	1200	1199 PANIGALE S	2012	2013	FP007	N	MV AGUSTA	1000	F4 - F4R - F4RR	2013	2015	FP014	N
DUCATI	1200	1199 PANIGALE S TRICOLORE	2012	2013	FP007	N	MV AGUSTA	1000	F4 RC - RC LH	2015	2018	FP014	N
DUCATI	1200	1199 PANIGALE ABS	2012	2013	FP007	N	SUZUKI	1000	TL1000 R W-Y	1998	2000	FP008	N
DUCATI	1200	1199 PANIGALE SUPERLEGGERA	2014	2014	FP007	N	SUZUKI	1000	SV1000 K3-K7	2003	2007	FP008	N
DUCATI	1200	1199 PANIGALE R	2013	2014	FP007	N	SUZUKI	1000	GSX-R1000 K7-K8	2007	2008	FP008	N
DUCATI	1200	MULTISTRADA 1200 S TOURING D-AIR	2014	2014	FP007	N							
DUCATI	1200	MULTISTRADA 1200 S GT	2013	2014	FP007	N							
DUCATI	1200	1199 PANIGALE S ABS	2012	2015	FP007	N							
DUCATI	1200	MONSTER 1200 S STRIPE	2015	2016	FP007	N							
DUCATI	1200	PANIGALE R	2015	2017	FP007	N							
DUCATI	1200	DIAVEL	2011	2017	FP007	N							
DUCATI	1200	MULTISTRADA 1200 TOURING	2015	2017	FP007	N							
DUCATI	1200	MULTISTRADA 1200 S TOURING	2010	2017	FP007	N							
DUCATI	1200	MULTISTRADA 1200 S PIKES PEAK	2012	2017	FP007	N							

BRAKE/CLUTCH MASTER CYLINDERS
 ACCESSORIES SPARE PARTS
 CNC-WORKED FLUID RESERVOIR
 FULL CLUTCH
 HYDRAULIC-CLUTCH TRANFORMATION KIT
 LEVER
 THROTTLE CONTROL
 BRAKE CALIPER
 RACING KIT
 BUTTON PANEL
 LEVER GUARD
 CLIP-ON
 STREET RACING REARSET
 FUEL CAPS
 STEERING NUT
 CRASH PADS
 PADDOCK STAND
 MIRROR COVERS
 REAR-VIEW MIRRORS
 FOG LIGHTS KIT
 HANDLEBARS ACCESSORIES
 HANDLEBARS

TAPPO VASCHETTA OLIO FRENO POSTERIORE

REAR BRAKE OIL RESERVOIR CAP



Colori / Colours

N ●
nero - black

O ●
arancione
orange

Y ●
oro - gold

B ●
blu - blue

R ●
rosso - red

S ●
argento - silver

G ●
verde - green

- BRAKE/CLUTCH MASTER CYLINDERS
- ACCESSORIES SPARE PARTS
- CNC-WORKED FLUID RESERVOIR
- FULL CLUTCH
- HYDRAULIC-CLUTCH TRANSFORMATION KIT
- LEVER
- THROTTLE CONTROL
- BRAKE CALIPER
- RACING KIT
- BUTTON PANEL
- LEVER GUARD
- CLIP-ON
- STREET RACING REARSET
- FUEL CAPS
- STEERING NUT
- CRASH PADS
- PADDOCK STAND
- MIRROR COVERS
- REAR-VIEW MIRRORS
- FOG LIGHTS KIT
- HANDLEBARS ACCESSORIES
- HANDLEBARS

Applicazioni / Application list

Marca Brand	CC	Modello Model	Dal From	Al To	Codice Code	Novità New	Marca Brand	CC	Modello Model	Dal From	Al To	Codice Code	Novità New
APRILIA	750	DORSODURO 750	2008	2016	TS013		DUCATI	796	MONSTER 796 ANNIVERSARY / ABS ANNIVERSARY	2013	2013	TS012	N
APRILIA	750	SHIVER 750	2007	2016	TS013		DUCATI	797	MONSTER 797	2017	2018	TS012	N
APRILIA	750	SHIVER GT	2007	2014	TS013		DUCATI	797	MONSTER 797 PLUS	2017	2018	TS012	N
APRILIA	750	DORSODURO FACTORY	2010	2013	TS013	N	DUCATI	800	SCRAMBLER CAFE RACER	2017	2020	TS012	N
APRILIA	900	SHIVER 900	2017	2019	TS013	N	DUCATI	800	SCRAMBLER DESERT SLEED	2017	2020	TS012	N
APRILIA	900	DORSODURO 900	2017	2018	TS013	N	DUCATI	800	SCRAMBLER FULL THROTTLE/ICON	2015	2020	TS012	N
APRILIA	1000	SL FALCO	2000	2003	TS013	N	DUCATI	800	SCRAMBLER CLASSIC	2015	2018	TS012	N
APRILIA	1200	DORSODURO 1200	2010	2016	TS012		DUCATI	800	SCRAMBLER MACH 2.0	2018	2018	TS012	N
BENELLI	500	LEONCINO 500 / TRAIL	2017	2019	TS012	N	DUCATI	800	SCRAMBLER STREET CLASSIC	2018	2018	TS012	N
BENELLI	500	TRK 502 ABS	2017	2019	TS012	N	DUCATI	800	SCRAMBLER FLAT TRACK PRO	2016	2016	TS012	N
BMW	1000	F800 R	2009	2014	TS012	N	DUCATI	800	SCRAMBLER INDEPENDENT / INDEPENDENT U	2016	2016	TS012	N
DUCATI	400	SCRAMBLER SIXTY2	2016	2020	TS012	N	DUCATI	800	SCRAMBLER URBAN ENDURO	2015	2016	TS012	N
DUCATI	400	SCRAMBLER HASHTAG	2018	2018	TS012	N	DUCATI	800	HYPERMOTARD 796	2010	2012	TS012	N
DUCATI	400	MONSTER 400	2000	2008	TS012	N	DUCATI	800	MONSTER 800 S2R	2005	2007	TS012	N
DUCATI	400	MONSTER 400 DARK	2005	2005	TS012	N	DUCATI	800	MONSTER S2R DARK	2005	2006	TS012	N
DUCATI	400	MONSTER 400	1995	1997	TS012	N	DUCATI	800	SUPERSPORT 800 SS	2003	2005	TS012	N
DUCATI	400	SUPERSPORT 400 SS	1993	1996	TS012	N	DUCATI	800	MONSTER 800	2003	2004	TS012	N
DUCATI	600	MONSTER 600	1993	2000	TS012	N	DUCATI	800	SUPERSPORT 800 S	2003	2003	TS012	N
DUCATI	600	MONSTER 600 CITY	1999	1999	TS012	N	DUCATI	821	MONSTER 821 DARK	2015	2020	TS012	N
DUCATI	600	MONSTER 600 DARK	1998	1998	TS012	N	DUCATI	821	MONSTER 821	2014	2019	TS012	N
DUCATI	600	SUPERSPORT 600 SS	1991	1997	TS012	N	DUCATI	821	MONSTER 821 STEALTH	2019	2019	TS012	N
DUCATI	620	MONSTER 620	2002	2006	TS012	N	DUCATI	821	MONSTER 821 STRIPES	2015	2017	TS012	N
DUCATI	620	MONSTER 620 DARK	2005	2006	TS012	N	DUCATI	821	HYPERMOTARD 821	2013	2015	TS012	N
DUCATI	620	MULTISTRADA 620 / 620 DARK	2006	2006	TS012	N	DUCATI	821	HYPERMOTARD 821 LOW SEAT	2015	2015	TS012	N
DUCATI	620	MONSTER 620 DARK SINGLE DISK	2005	2005	TS012	N	DUCATI	821	HYPERMOTARD 821 SP	2013	2015	TS012	N
DUCATI	620	SUPERSPORT 620 S	2003	2003	TS012	N	DUCATI	821	HYPERMOTARD HYPERSTRADA 821	2013	2015	TS012	N
DUCATI	695	MONSTER 695	2007	2008	TS012	N	DUCATI	848	STREETFIGHTER	2009	2016	TS012	N
DUCATI	696	MONSTER 696 / 696 ABS	2008	2014	TS012		DUCATI	850	848 EVO	2011	2013	TS012	N
DUCATI	696	MONSTER 696 ANNIVERSARY / ABS ANNIVERSARY	2013	2013	TS012	N	DUCATI	850	848 EVO CORSE SE	2012	2013	TS012	N
DUCATI	748	749 DARK	2004	2006	TS012	N	DUCATI	850	848	2008	2010	TS012	
DUCATI	748	749 R	2004	2006	TS012	N	DUCATI	850	848 HAYDEN	2010	2010	TS012	N
DUCATI	748	749 S	2003	2006	TS012	N	DUCATI	851	851	1992	1992	TS012	N
DUCATI	748	749	2003	2003	TS012	N	DUCATI	888	888	1994	1995	TS012	N
DUCATI	748	748 R SINGLE SEAT	2001	2002	TS012	N	DUCATI	888	888 SP5	1993	1993	TS012	N
DUCATI	748	748	1995	2001	TS012		DUCATI	899	899	2012	2016	TS012	N
DUCATI	748	748 RS	2000	2001	TS012	N	DUCATI	899	899 PANIGALE ABS	2014	2015	TS012	N
DUCATI	748	748 S	2000	2000	TS012	N	DUCATI	900	MONSTER 900	1993	2002	TS012	N
DUCATI	748	748 R	1999	1999	TS012	N	DUCATI	900	SPORT CLASSIC MH900E	2001	2002	TS012	N
DUCATI	748	748 SPS	1998	1999	TS012	N	DUCATI	900	SUPERSPORT 900 S	2002	2002	TS012	N
DUCATI	750	MONSTER 750	1996	2002	TS012	N	DUCATI	900	SUPERSPORT 900 SS	1991	2002	TS012	N
DUCATI	750	SUPERSPORT 750 S	2001	2002	TS012	N	DUCATI	900	MONSTER 900 CITY / DARK CITY	1999	1999	TS012	N
DUCATI	750	SUPERSPORT 750 SS	1991	2002	TS012	N	DUCATI	900	MONSTER 900 S / CROMO	1998	1998	TS012	N
DUCATI	750	MONSTER 750 CITY / DARK	1999	1999	TS012	N	DUCATI	900	SUPERSPORT 900 SS FINAL EDITION	1998	1998	TS012	N
DUCATI	795	MONSTER 795 ABS CORSE STRIPE	2014	2015	TS012	N	DUCATI	916	SPORT TOURING ST4	1999	2003	TS012	N
DUCATI	795	MONSTER 795 ABS RED STRIPE C	2015	2015	TS012	N	DUCATI	916	MONSTER S4	2001	2002	TS012	N
DUCATI	796	MONSTER 796	2008	2015	TS012	N	DUCATI	916	MONSTER S4 FOGARTY	2002	2002	TS012	N
DUCATI	796	MONSTER 796 / 796 ABS	2011	2013	TS012	N	DUCATI	916	916 R	1997	1998	TS012	N

BRAKE/CLUTCH
 MASTER CYLINDERS
 ACCESSORIES
 SPARE PARTS
 CNC-WORKED FLUID
 RESERVOIR
 FULL CLUTCH
 HYDRAULIC-CLUTCH
 TRANFORMATION KIT
 LEVER
 THROTTLE CONTROL
 BRAKE CALIPER
 RACING KIT
 BUTTON PANEL
 LEVER GUARD
 CLIP-ON
 STREET RACING
 REARSET
 FUEL CAPS
 STEERING NUT
 CRASH PADS
 PADDOCK STAND
 MIRROR COVERS
 REAR-VIEW MIRRORS
 FOG LIGHTS KIT
 HANDLEBARS
 ACCESSORIES
 HANDLEBARS

Marca Brand	CC	Modello Model	Dal From	Al To	Codice Code	Novità New	Marca Brand	CC	Modello Model	Dal From	Al To	Codice Code	Novità New
DUCATI	916	916 SENNA	1994	1998	TS012	N	DUCATI	1000	SPORT CLASSIC PAUL SMART	2006	2006	TS012	N
DUCATI	916	916 SPS	1997	1998	TS012	N	DUCATI	1000	SUPERSPORT 1000 SS	2003	2006	TS012	N
DUCATI	916	916	1994	1997	TS012		DUCATI	1000	MONSTER 1000	2003	2005	TS012	N
DUCATI	916	916 SP	1994	1996	TS012	N	DUCATI	1000	MONSTER 1000 S	2005	2005	TS012	N
DUCATI	936	SUPERSPORT 936	2019	2019	TS012	N	DUCATI	1098	STREETFIGHTER 1098 S	2010	2013	TS012	N
DUCATI	936	SUPERSPORT 936 S	2017	2018	TS012	N	DUCATI	1098	1098	2007	2011	TS012	
DUCATI	936	SUPERSPORT 936	2017	2017	TS012	N	DUCATI	1100	PANIGALE V4	2018	2019	TS012	N
DUCATI	939	HYPERMOTARD 939 / 939 SP / 939 SP U	2016	2018	TS012	N	DUCATI	1100	PANIGALE V4 S	2018	2019	TS012	N
DUCATI	939	HYPERMOTARD HYPERSTRADA 939	2016	2016	TS012	N	DUCATI	1100	PANIGALE V4 S CORSE	2019	2019	TS012	N
DUCATI	944	SPORT TOURING 944 ST2	1997	1998	TS012	N	DUCATI	1100	PANIGALE V4 SPECIALE	2018	2019	TS012	N
DUCATI	950	HYPERMOTARD 950 / 950 SP / 950 SP U	2019	2019	TS012	N	DUCATI	1100	SCRAMBLER 1100 SPORT / SPECIAL	2018	2019	TS012	N
DUCATI	955	959 PANIGALE ABS	2017	2019	TS012	N	DUCATI	1100	SCRAMBLER 1100	2018	2018	TS012	N
DUCATI	955	959 PANIGALE CORSE / CORSE U	2018	2019	TS012	N	DUCATI	1100	STREETFIGHTER 1100	2009	2016	TS012	
DUCATI	994	SPORT TOURING ST2	1999	2003	TS012	N	DUCATI	1100	MONSTER 1100 ABS / S ABS	2010	2013	TS012	N
DUCATI	996	SPORT TOURING ST4 S	2001	2005	TS012	N	DUCATI	1100	MONSTER 1100 DIESEL	2013	2013	TS012	N
DUCATI	996	SPORT TOURING ST4 S ABS	2003	2005	TS012	N	DUCATI	1100	MONSTER 1100 EVO ABS	2012	2013	TS012	N
DUCATI	996	996	1999	2001	TS012		DUCATI	1100	MONSTER 1100 EVO ANNIVERSARY	2013	2013	TS012	N
DUCATI	996	996 RS	2000	2001	TS012	N	DUCATI	1100	HYPERMOTARD 1100 EVO / EVO SP	2010	2012	TS012	N
DUCATI	996	996 S	2001	2001	TS012	N	DUCATI	1100	HYPERMOTARD 1100	2009	2011	TS012	
DUCATI	996	996 R	1999	2000	TS012	N	DUCATI	1100	MONSTER 1100 / 1100S	2009	2010	TS012	N
DUCATI	996	996 R II	2000	2000	TS012	N	DUCATI	1100	MONSTER 1100 EVO	2010	2010	TS012	N
DUCATI	996	996 SPS	1999	2000	TS012	N	DUCATI	1100	HYPERMOTARD 1100/1100S	2008	2009	TS012	N
DUCATI	996	996 SPS III	2000	2000	TS012	N	DUCATI	1100	MULTISTRADA 1100 / 1100 S	2007	2009	TS012	N
DUCATI	996	996 SPS II	1999	1999	TS012	N	DUCATI	1100	HYPERMOTARD 1100S			TS012	N
DUCATI	998	PANIGALE V4 R	2019	2019	TS012	N	DUCATI	1199	PANIGALE 1199	2012	2017	TS012	N
DUCATI	998	999 S AMA REPLICA	2007	2007	TS012	N	DUCATI	1199	1199 PANIGALE	2012	2016	TS012	N
DUCATI	998	999/999R/999S	2003	2006	TS012	N	DUCATI	1200	MONSTER 1200 / 1200S	2014	2019	TS012	N
DUCATI	998	998 FINAL EDITION / FINAL ED. SINGLE SEAT	2004	2004	TS012	N	DUCATI	1200	MONSTER 1200R	2016	2019	TS012	N
DUCATI	998	998 MATRIX / MATRIX SINGLE SEAT	2004	2004	TS012	N	DUCATI	1200	PANIGALE R	2015	2017	TS012	N
DUCATI	998	998	2002	2003	TS012		DUCATI	1200	1198	2015	2015	TS012	
DUCATI	998	998 R	2002	2002	TS012	N	DUCATI	1200	MONSTER 1200 S STRIPES	2015	2015	TS012	N
DUCATI	998	998 S BAYLISS	2002	2002	TS012	N	DUCATI	1200	1199 PANIGALE ABS / PANIGALE S ABS	2012	2014	TS012	N
DUCATI	998	998 S BOSTROM	2002	2002	TS012	N	DUCATI	1200	1199 PANIGALE R	2013	2014	TS012	N
DUCATI	1000	SPORT CLASSIC GT 1000	2007	2010	TS012	N	DUCATI	1200	1199 PANIGALE SUPERLEGGERA	2014	2014	TS012	N
DUCATI	1000	SPORT CLASSIC 1000S	2007	2009	TS012	N	DUCATI	1200	MULTISTRADA 1200 ABS / S TOURING	2010	2014	TS012	N
DUCATI	1000	SPORT CLASSIC GT 1000 TOURING	2009	2009	TS012	N	DUCATI	1200	MULTISTRADA 1200 S GT	2013	2014	TS012	N
DUCATI	1000	DESMOSEDICI RR	2008	2008	TS012	N	DUCATI	1200	MULTISTRADA 1200 S PIKES PEAK	2012	2014	TS012	N
DUCATI	1000	MONSTER 1000 S2R	2006	2008	TS012	N	DUCATI	1200	MULTISTRADA 1200 S TOURING D-AIR	2014	2014	TS012	N
DUCATI	1000	MONSTER S4R	2003	2008	TS012		DUCATI	1200	MULTISTRADA 1200S	2010	2014	TS012	
DUCATI	1000	MONSTER S4RS	2006	2008	TS012	N	DUCATI	1200	1199 PANIGALE / PANIGALE S	2012	2013	TS012	N
DUCATI	1000	MONSTER S4RS TRICOLORE	2008	2008	TS012	N	DUCATI	1200	1199 PANIGALE S TRICOLORE	2012	2013	TS012	N
DUCATI	1000	SPORT CLASSIC SPORT 1000	2007	2008	TS012	N	DUCATI	1200	MULTISTRADA 1200	2010	2012	TS012	N
DUCATI	1000	SPORT CLASSIC SPORT 1000 SINGLE SEAT	2006	2007	TS012	N	DUCATI	1200	MULTISTRADA 1200 S SPORT	2011	2012	TS012	N
DUCATI	1000	SPORT TOURING ST3	2004	2007	TS012	N	DUCATI	1200	1198	2007	2011	TS012	N
DUCATI	1000	SPORT TOURING ST3 S ABS	2006	2007	TS012	N	DUCATI	1200	1198 SP	2011	2011	TS012	N
DUCATI	1000	MULTISTRADA 1000	2003	2006	TS012	N	DUCATI	1200	1198 R	2010	2010	TS012	N
DUCATI	1000	MULTISTRADA 1000 S	2003	2006	TS012	N	DUCATI	1200	1198 S	2009	2010	TS012	N

- BRAKE/CLUTCH MASTER CYLINDERS
- ACCESSORIES SPARE PARTS
- CNC-WORKED FLUID RESERVOIR
- FULL CLUTCH
- HYDRAULIC-CLUTCH TRANFORMATION KIT
- LEVER
- THROTTLE CONTROL
- BRAKE CALIPER
- RACING KIT
- BUTTON PANEL
- LEVER GUARD
- CLIP-ON
- STREET RACING REARSET
- FUEL CAPS
- STEERING NUT
- CRASH PADS
- PADDOCK STAND
- MIRROR COVERS
- REAR-VIEW MIRRORS
- FOG LIGHTS KIT
- HANDLEBARS ACCESSORIES
- HANDLEBARS

Marca Brand	CC	Modello Model	Dal From	Al To	Codice Code	Novità New	Marca Brand	CC	Modello Model	Dal From	Al To	Codice Code	Novità New
DUCATI	1200	1198 S CORSE	2010	2010	TS012	N	KAWASAKI	800	Z800 E SPECIAL EDITION / E SPECIAL EDITION ABS	2013	2016	TS013	N
DUCATI	1200	MULTISTRADA 1200 S ABS	2010	2010	TS012	N	KAWASAKI	900	Z900 A2	2018	2020	TS013	N
DUCATI	1200	1098 R	2008	2009	TS012	N	KAWASAKI	900	Z900 RS CAFE	2018	2020	TS013	N
DUCATI	1200	1098 R BAYLISS	2009	2009	TS012	N	KAWASAKI	900	Z900	2018	2019	TS013	N
DUCATI	1200	1098 S / S TRICOLORE	2007	2008	TS012	N	KAWASAKI	900	Z900 ABS	2017	2017	TS013	N
DUCATI	1200	MONSTER 1200 25° ANNIVERSARIO	2000	2000	TS012	N	KAWASAKI	1000	Z1000	2007	2020	TS013	N
DUCATI	1260	DIAVEL 1260	2019	2020	TS012	N	KAWASAKI	1000	Z1000 ABS	2007	2020	TS013	N
DUCATI	1260	DIAVEL 1260 S	2019	2020	TS012	N	KAWASAKI	1000	KLZ VERSYS	2012	2019	TS013	N
DUCATI	1262	XDIAVEL	2016	2020	TS012	N	KAWASAKI	1000	KLZ VERSYS SE	2019	2019	TS013	N
DUCATI	1262	XDIAVEL S	2016	2020	TS012	N	KAWASAKI	1000	NINJA H2/H2R	2015	2019	TS013	N
DUCATI	1262	XDIAVEL SPORT PACK B	2017	2018	TS012	N	KAWASAKI	1000	NINJA ZX-10R	2008	2019	TS013	N
DUCATI	1299	1299 R FINAL EDITION	2018	2018	TS012	N	KAWASAKI	1000	Z1000SX	2011	2019	TS013	N
DUCATI	1299	1299 ABS	2015	2017	TS012	N	KAWASAKI	1000	NINJA ZX-10RR	2017	2018	TS013	N
DUCATI	1299	1299 S ABS	2015	2017	TS012	N	KAWASAKI	1000	NINJA ZX-10R	2006	2007	TS005	N
DUCATI	1299	1299 SUPERLEGGERA	2017	2017	TS012	N	KTM	690	690 SM	2007	2012	TS012	N
DUCATI	1299	PANIGALE 1299	2012	2017	TS012	N	KTM	690	690 SMR	2007	2012	TS012	N
DUCATI	1299	SUPERBIKE 1299S 90° ANNIVERSARIO	2000	2000	TS012	N	KTM	990	SUPER DUKE 990	2007	2012	TS012	N
HONDA	1000	CBR 1000 RR	2017	2017	TS013	N	KTM	1290	SUPER DUKE 1290	2014	2018	TS012	N
HONDA	1000	CB1000R	2008	2017	TS005	N	SUZUKI	600	GSX-R 600	2011	2017	TS013	N
HONDA	1000	CB1000R	2008	2010	TS013	N	SUZUKI	750	GSX-R 750	2011	2017	TS013	N
HONDA	1000	CBR1000RR	2004	2005	TS013	N	SUZUKI	1000	GSX-R 1000	2017	2019	TS012	N
HUSQVARNA	701	VITPILEN 701	2018	2018	TS012	N	TRIUMPH	675	DAYTONA 675 / 675 R	2007	2016	TS013	N
KAWASAKI	125	NINJA 125	2019	2020	TS013	N	TRIUMPH	675	STREET TRIPLE 675 / 675 R	2007	2016	TS013	N
KAWASAKI	125	Z125	2019	2020	TS013	N	TRIUMPH	765	STREET TRIPLE 765 RS	2017	2017	TS013	N
KAWASAKI	250	NINJA 250	2018	2018	TS013	N	TRIUMPH	1050	SPEED TRIPLE	2012	2018	TS013	N
KAWASAKI	250	Z250SL	2015	2017	TS013	N	YAMAHA	80	YZ 80 N - LW	2001	2001	TS013	N
KAWASAKI	250	NINJA 250 SL	2015	2016	TS013	N	YAMAHA	80	YZ 80 LC - LW	1994	1997	TS013	N
KAWASAKI	250	NINJA 250 R	2009	2012	TS005	N	YAMAHA	85	YZ 85 LW	2018	2019	TS013	N
KAWASAKI	300	KLE VERSYS-X ABS	2019	2020	TS013	N	YAMAHA	85	YZ 85	2002	2017	TS013	N
KAWASAKI	300	Z300 ABS	2017	2018	TS013	N	YAMAHA	125	WR 125 X	2013	2014	TS013	N
KAWASAKI	300	NINJA 300	2013	2016	TS013	N	YAMAHA	125	WR 125 R	2009	2011	TS013	N
KAWASAKI	300	NINJA 300 ABS	2013	2016	TS013	N	YAMAHA	125	WR 125 X	2009	2011	TS013	N
KAWASAKI	300	Z300	2015	2016	TS013	N	YAMAHA	125	DT 125 RE	2004	2006	TS013	N
KAWASAKI	400	NINJA 400	2018	2020	TS013	N	YAMAHA	125	DT 125 RX	2005	2005	TS013	N
KAWASAKI	600	NINJA ZX-6R	2007	2008	TS013	N	YAMAHA	125	Z125 LC	1994	2002	TS013	N
KAWASAKI	650	VULCAN S	2015	2020	TS013	N	YAMAHA	125	DT 125 R	1989	2000	TS013	N
KAWASAKI	650	NINJA 650	2017	2019	TS013	N	YAMAHA	125	WR 125 LC	1995	1998	TS013	N
KAWASAKI	650	Z650	2017	2019	TS013	N	YAMAHA	200	WR 200	1993	1993	TS013	N
KAWASAKI	650	ER-6 N	2005	2008	TS005	N	YAMAHA	250	Z250 LC	1994	2002	TS013	N
KAWASAKI	650	ER-6 F	2006	2008	TS005	N	YAMAHA	250	TZ 250	1993	1995	TS013	N
KAWASAKI	750	Z750	2007	2012	TS013	N	YAMAHA	500	T-MAX	2012	2016	TS010	N
KAWASAKI	750	Z750 ABS	2007	2012	TS013	N	YAMAHA	530	T-MAX	2004	2017	TS010	N
KAWASAKI	750	Z750 R / R ABS	2011	2012	TS013	N	YAMAHA	600	YZF-R6	2006	2019	TS013	N
KAWASAKI	800	EJ800 (W800 CAFE)	2019	2020	TS013	N	YAMAHA	660	XT 660 Z TENERE	2008	2015	TS013	N
KAWASAKI	800	EJ800 (W800 STREET)	2019	2020	TS013	N	YAMAHA	660	XT 660 R / X	2014	2014	TS013	N
KAWASAKI	800	Z800	2013	2016	TS013	N	YAMAHA	660	MT-03	2006	2012	TS013	N
KAWASAKI	800	Z800 ABS / E / E ABS	2013	2016	TS013	N	YAMAHA	660	XT 660 R / X	2004	2011	TS013	N

BRAKE/CLUTCH
MASTER CYLINDERS
 ACCESSORIES
SPARE PARTS
 CNC-WORKED FLUID
RESERVOIR
 FULL CLUTCH
 HYDRAULIC-CLUTCH
TRANFORMATION KIT
 LEVER
 THROTTLE CONTROL
 BRAKE CALIPER
 RACING KIT
 BUTTON PANEL
 LEVER GUARD
 CLIP-ON
 STREET RACING
REARSET
 FUEL CAPS
 STEERING NUT
 CRASH PADS
 PADDOCK STAND
 MIRROR COVERS
 REAR-VIEW MIRRORS
 FOG LIGHTS KIT
 HANDLEBARS
ACCESSORIES
 HANDLEBARS

Marca Brand	CC	Modello Model	Dal From	Al To	Codice Code	Novità New
YAMAHA	700	MT-07 A	2017	2019	TS013	N
YAMAHA	700	MTM690 XSR 700	2016	2019	TS013	N
YAMAHA	700	MTM690 A TRACER	2016	2018	TS013	N
YAMAHA	700	XSR700	2016	2018	TS013	N
YAMAHA	700	MT-07 TRACER	2014	2017	TS013	
YAMAHA	700	MT-07	2014	2016	TS013	
YAMAHA	700	MT-07 A ABS	2014	2016	TS013	N
YAMAHA	700	MT-07 MC MOTO CAGE	2014	2014	TS013	N
YAMAHA	750	YZF-R7	1999	2000	TS013	N
YAMAHA	800	FZ8-NA/SA	2011	2015	TS013	N
YAMAHA	850	MT-09	2013	2019	TS013	N
YAMAHA	850	MT-09 A TRACER	2015	2019	TS013	N
YAMAHA	850	MTM850 D TRACER GT	2019	2019	TS013	N
YAMAHA	850	XSR900	2016	2019	TS013	N
YAMAHA	850	MT-09 SP	2018	2018	TS013	N
YAMAHA	850	MT-09 A TRACER GT	2018	2018	TS013	N
YAMAHA	850	MT-09 A ABS	2014	2016	TS013	N
YAMAHA	1000	MT-10	2016	2019	TS013	N
YAMAHA	1000	MT-10 D	2017	2017	TS013	N
YAMAHA	1000	YZF-R1	2009	2014	TS013	N
YAMAHA	1200	XT1200ZE SUPER TENERE	2014	2019	TS013	N

BRAKE/CLUTCH
MASTER CYLINDERS

ACCESSORIES
SPARE PARTS

CNC-WORKED FLUID
RESERVOIR

FULL CLUTCH

HYDRAULIC-CLUTCH
TRANFORMATION KIT

LEVER

THROTTLE CONTROL

BRAKE CALIPER

RACING KIT

BUTTON PANEL

LEVER GUARD

CLIP-ON

STREET RACING
REARSET

FUEL CAPS

STEERING NUT

CRASH PADS

PADDOCK STAND

MIRROR COVERS

REAR-VIEW MIRRORS

FOG LIGHTS KIT

HANDLEBARS
ACCESSORIES

HANDLEBARS

TAPPI OLIO

OIL FILLER CAP



Codice tappo
Oil filler cap code

FP001
FP002
FP003
FP004
FP005
FP006
FP009

Specifiche tecniche
Technical specifications

M20 X 1,5
M24 X 2
M22 X 1,5
M20 X 2,5
M30 X 1,5
M26 X 3
M25 X 1,5

Colori / Colours

N ●
nero - black

Y ●
oro - gold

B ●
blu - blue

R ●
rosso - red

S ●
argento - silver

G ●
verde - green

T ●
titanio - titanium

BRAKE/CLUTCH
MASTER CYLINDERS
ACCESSORIES
SPARE PARTS
CNC-WORKED FLUID
RESERVOIR
FULL CLUTCH
HYDRAULIC-CLUTCH
TRANSFORMATION KIT
LEVER
THROTTLE CONTROL
BRAKE CALIPER
RACING KIT
BUTTON PANEL
LEVER GUARD
CLIP-ON
STREET RACING
REARSET
FUEL CAPS
STEERING NUT
CRASH PADS
PADDOCK STAND
MIRROR COVERS
REAR-VIEW MIRRORS
FOG LIGHTS KIT
HANDLEBARS
ACCESSORIES
HANDLEBARS

Applicazioni / Application list

Marca Brand	CC	Modello Model	Dal From	Al To	Codice tappo olio Oil filter cap code	Novità New	Marca Brand	CC	Modello Model	Dal From	Al To	Codice tappo olio Oil filter cap code	Novità New
APRILIA	250	RS 250	1995	2002	FP001		DUCATI	400	MONSTER 400 DARK	2005	2005	FP003	N
APRILIA	450	SXV 4.5/5.5	2006	2011	FP001	N	DUCATI	400	MONSTER 400	2000	2008	FP003	N
APRILIA	450	RXV 4.5-5.5 - SXV 4.5/5.5 REPLICA	2008	2008	FP001	N	DUCATI	400	MONSTER 400	1995	1997	FP003	N
APRILIA	450	RXV 4.5-5.5 - SXV 4.5/5.5 PIKES PEAK	2009	2009	FP001	N	DUCATI	600	SUPERSPORT 600 SS	1991	1997	FP003	N
APRILIA	450	RXV 4.5/5.5	2006	2011	FP001	N	DUCATI	600	MONSTER 600 DARK	1998	1999	FP003	N
APRILIA	450	MXV	2009	2011	FP001	N	DUCATI	600	MONSTER 600 CITY	1999	1999	FP003	N
APRILIA	750	SHIVER 750 GT	2007	2015	FP001		DUCATI	600	MONSTER 600	1993	2001	FP003	
APRILIA	750	SHIVER	2007	2016	FP001	N	DUCATI	620	SUPERSPORT 620 S	2003	2003	FP003	N
APRILIA	750	DORSODURO FACTORY	2014	2016	FP001	N	DUCATI	620	MULTISTRADA 620 DARK	2006	2006	FP003	N
APRILIA	750	DORSODURO 750	2014	2016	FP001		DUCATI	620	MULTISTRADA 620	2006	2006	FP003	N
APRILIA	750	DORSODURO 750	2008	2013	FP009		DUCATI	620	MONSTER 620 DARK SINGLE DISK	2005	2005	FP003	N
APRILIA	900	SHIVER EURO 4 ABS NAVI	2019	2019	FP001	N	DUCATI	620	MONSTER 620 DARK	2005	2006	FP003	N
APRILIA	900	SHIVER	2017	2018	FP001	N	DUCATI	620	MONSTER 620	2002	2006	FP003	
APRILIA	900	DORSODURO EURO 4 ABS	2018	2018	FP001	N	DUCATI	695	MONSTER 695	2007	2008	FP003	N
APRILIA	900	DORSODURO	2017	2017	FP001	N	DUCATI	696	MONSTER 696 ANNIVERSARY	2013	2013	FP004	N
APRILIA	1000	TUONO V4	2011	2018	FP009	N	DUCATI	696	MONSTER 696 ABS ANNIVERSARY	2013	2013	FP004	N
APRILIA	1000	TUONO	2006	2009	FP001		DUCATI	696	MONSTER 696 ABS	2010	2014	FP004	N
APRILIA	1000	SL FALCO 1000	2000	2003	FP001		DUCATI	696	MONSTER 696	2008	2015	FP004	
APRILIA	1000	RSV4 RR EURO 4 ABS	2019	2019	FP009	N	DUCATI	748	748 SPS	1998	1999	FP003	N
APRILIA	1000	RSV4 RR	2015	2018	FP009	N	DUCATI	748	748 S	2000	2002	FP003	N
APRILIA	1000	RSV4 R	2009	2010	FP009	N	DUCATI	748	748 RS	2000	2001	FP003	N
APRILIA	1000	RSV4 FACTORY APRC STD - SE	2013	2014	FP009	N	DUCATI	748	748 R - SINGLE SEAT	1998	2002	FP003	N
APRILIA	1000	RSV4 FACTORY - SBK RACING	2009	2010	FP009	N	DUCATI	748	748 E	2001	2002	FP003	N
APRILIA	1000	RSV4 APRC R ABS	2013	2014	FP009	N	DUCATI	748	748	1995	2003	FP003	
APRILIA	1000	RSV4 APRC R	2011	2012	FP009	N	DUCATI	749	749 S	2003	2006	FP003	N
APRILIA	1000	RSV SP	1999	2000	FP001	N	DUCATI	749	749 R	2004	2006	FP003	N
APRILIA	1000	RSV R TUONO	2002	2005	FP001	N	DUCATI	749	749 DARK	2004	2006	FP003	N
APRILIA	1000	RSV R - FACTORY - DREAM	2004	2008	FP001	N	DUCATI	749	749	2003	2003	FP003	
APRILIA	1000	RSV 4 + FACTORY APRS	2009	2018	FP009	N	DUCATI	750	SUPERSPORT 750 SS	1991	2002	FP003	
APRILIA	1000	RSV 1000 R	2000	2003	FP001		DUCATI	750	SUPERSPORT 750 S	2001	2002	FP003	N
APRILIA	1000	RSV 1000	1998	2003	FP001		DUCATI	750	MONSTER 750 DARK	1999	1999	FP003	N
APRILIA	1000	RST FUTURA	2001	2003	FP001	N	DUCATI	750	MONSTER 750 CITY	1999	1999	FP003	N
APRILIA	1000	ETV CAPO NORD ABS	2004	2007	FP001	N	DUCATI	750	MONSTER 750	1996	2002	FP003	
APRILIA	1000	ETV CAPO NORD - RALLY	2001	2003	FP001	N	DUCATI	795	MONSTER 795 ABS RED STRIPE C	2015	2015	FP004	N
APRILIA	1100	TUONO V4 RR	2015	2018	FP009	N	DUCATI	795	MONSTER 795 ABS CORSE STRIPE	2014	2015	FP004	N
APRILIA	1100	TUONO V4 RF ABS	2018	2018	FP009	N	DUCATI	796	MONSTER 796 ANNIVERSARY	2013	2013	FP004	N
APRILIA	1100	TUONO V4 FACTORY	2015	2017	FP009	N	DUCATI	796	MONSTER 796 ABS ANNIVERSARY	2013	2013	FP004	N
APRILIA	1100	RSV4 RR RACER PACK	2015	2015	FP009	N	DUCATI	796	MONSTER 796 ABS	2011	2014	FP004	N
APRILIA	1100	RSV4 RACING FACTORY LE	2015	2017	FP009	N	DUCATI	796	MONSTER 796	2011	2013	FP004	N
APRILIA	1100	RSV4 RACING FACTORY EURO 4 ABS	2019	2019	FP009	N	DUCATI	796	HYPER MOTARD 796	2010	2012	FP004	
APRILIA	1100	RSV4 RACING FACTORY ABS	2018	2018	FP009	N	DUCATI	800	SUPERSPORT 800 SS	2003	2005	FP003	N
APRILIA	1200	DORSODURO 1200	2010	2016	FP001		DUCATI	800	SUPERSPORT 800 S	2003	2003	FP003	N
APRILIA	1200	CAPONORD RALLY	2015	2015	FP001	N	DUCATI	800	SCRAMBLER	2015	2018	FP004	N
APRILIA	1200	CAPONORD CARABINIERI	2015	2015	FP001	N	DUCATI	800	MONSTER S2R 800 DARK	2005	2006	FP003	N
APRILIA	1200	CAPONORD	2013	2016	FP001	N	DUCATI	800	MONSTER S2R 800	2005	2007	FP003	N
BENELLI	300	BN 302	2015	2017	FP001	N	DUCATI	800	MONSTER 800	2003	2004	FP003	N
BENELLI	300	302 R ABS	2017	2017	FP001	N	DUCATI	821	MONSTER 821 STRIPES	2015	2017	FP004	N
BENELLI	500	TRK 502 X / ABS	2017	2019	FP001	N	DUCATI	821	MONSTER 821 STEALTH	2019	2019	FP004	N
BENELLI	500	LEONCINO 500	2017	2019	FP001	N	DUCATI	821	MONSTER 821 DARK	2015	2020	FP004	N
BMW	1000	S 1000 RR	2009	2018	FP002	N	DUCATI	821	MONSTER 821	2015	2019	FP004	N
BMW	1000	S 1000 R	2014	2018	FP002	N	DUCATI	821	HYPERSTRADA 821	2013	2016	FP004	
DUCATI	400	SUPERSPORT 400 SS	1993	1997	FP003	N	DUCATI	821	HYPER MOTARD SP	2013	2015	FP004	N

BRAKE/CLUTCH
MASTER CYLINDERS
ACCESSORIES
SPARE PARTS
CNC-WORKED FLUID
RESERVOIR
FULL CLUTCH
HYDRAULIC-CLUTCH
TRANFORMATION KIT
LEVER
THROTTLE CONTROL
BRAKE CALIPER
RACING KIT
BUTTON PANEL
LEVER GUARD
CLIP-ON
STREET RACING
REARSET
FUEL CAPS
STEERING NUT
CRASH PADS
PADDOCK STAND
MIRROR COVERS
REAR-VIEW MIRRORS
FOG LIGHTS KIT
HANDLEBARS
ACCESSORIES
HANDLEBARS

Marca Brand	CC	Modello Model	Dal From	Al To	Codice tappo olio Oil filter cap code	Novità New	Marca Brand	CC	Modello Model	Dal From	Al To	Codice tappo olio Oil filter cap code	Novità New
DUCATI	821	HYPER MOTARD LOW SEAT	2015	2015	FP004	N	DUCATI	996	996 SPS III	2000	2000	FP003	N
DUCATI	821	HYPER MOTARD HYPERSTRADA	2013	2015	FP004	N	DUCATI	996	996 SPS II	1999	1999	FP003	N
DUCATI	821	HYPER MOTARD 821	2013	2015	FP004	N	DUCATI	996	996 SPS	1999	2000	FP003	N
DUCATI	848	STREETFIGHTER 848	2011	2016	FP004	N	DUCATI	996	996 S	2001	2001	FP003	N
DUCATI	848	848 HAYDEN	2010	2010	FP004	N	DUCATI	996	996 RS	2000	2001	FP003	N
DUCATI	848	848 EVO CORSE SE	2012	2013	FP004	N	DUCATI	996	996 R II	2001	2001	FP003	N
DUCATI	848	848 EVO	2011	2013	FP004	N	DUCATI	996	996 R	1999	2001	FP003	N
DUCATI	848	848	2007	2011	FP004	N	DUCATI	996	996	1999	2001	FP003	N
DUCATI	851	851	1991	1992	FP003	N	DUCATI	998	998 S BAYLISS	2002	2002	FP003	N
DUCATI	888	888 SP5	1993	1993	FP003	N	DUCATI	998	998 RS	2002	2003	FP003	N
DUCATI	888	888	1994	1995	FP003	N	DUCATI	998	998 R	2002	2002	FP003	N
DUCATI	899	PANIGALE 899	2012	2015	FP004	N	DUCATI	998	998 MATRIX	2004	2004	FP003	N
DUCATI	899	899 PANIGALE ABS	2014	2015	FP004	N	DUCATI	998	998 FINAL EDITION	2004	2004	FP003	N
DUCATI	900	SUPERSPORT 900 SS FINAL EDITION	1998	1998	FP003	N	DUCATI	998	998 BOSTROM	2002	2002	FP003	N
DUCATI	900	SUPERSPORT 900 SS	1991	2002	FP003	N	DUCATI	998	998	2002	2003	FP003	N
DUCATI	900	SUPERSPORT 900 S	2002	2002	FP003	N	DUCATI	999	999 S	2003	2006	FP003	N
DUCATI	900	SPORT CLASSIC MH900E	2001	2002	FP003	N	DUCATI	999	999 RS	2004	2005	FP003	N
DUCATI	900	MONSTER 900 S	1998	1998	FP003	N	DUCATI	999	999 R XEROX	2006	2006	FP003	N
DUCATI	900	MONSTER 900 DARK CITY	1999	1999	FP003	N	DUCATI	999	999 R	2003	2006	FP003	N
DUCATI	900	MONSTER 900 CROMO	1998	1998	FP003	N	DUCATI	999	999 AMA REPLICIA	2007	2007	FP003	N
DUCATI	900	MONSTER 900 CITY	1999	1999	FP003	N	DUCATI	999	999	2003	2006	FP003	N
DUCATI	900	MONSTER 900	1993	2002	FP003	N	DUCATI	1000	SUPERSPORT 1000 SS	2003	2006	FP003	N
DUCATI	907	907 I.E.	1990	1993	FP003	N	DUCATI	1000	SPORT TOURING ST3 S ABS	2006	2007	FP003	N
DUCATI	916	SPORT TOURING ST4	1999	2003	FP003	N	DUCATI	1000	SPORT TOURING ST3	2004	2006	FP003	N
DUCATI	916	MONSTER S4 FOGARTY	2002	2002	FP003	N	DUCATI	1000	SPORT CLASSIC SPORT 1000	2007	2008	FP003	N
DUCATI	916	MONSTER S4	2001	2002	FP003	N	DUCATI	1000	SPORT CLASSIC PAUL SMART	2006	2006	FP003	N
DUCATI	916	916 SPS	1997	1998	FP003	N	DUCATI	1000	SPORT CLASSIC GT 1000 TOURING	2009	2009	FP003	N
DUCATI	916	916 SP	1994	1996	FP003	N	DUCATI	1000	SPORT CLASSIC GT 1000	2007	2010	FP003	N
DUCATI	916	916 SENNA	1994	1998	FP003	N	DUCATI	1000	SPORT CLASSIC 1000 SINGLE SEAT	2006	2007	FP003	N
DUCATI	916	916 R	1997	1998	FP003	N	DUCATI	1000	SPORT CLASSIC 1000 S	2007	2009	FP003	N
DUCATI	916	916	1994	1997	FP003	N	DUCATI	1000	MULTISTRADA 1000 S	2005	2006	FP003	N
DUCATI	936	SUPERSPORT S	2017	2019	FP004	N	DUCATI	1000	MULTISTRADA 1000	2003	2006	FP003	N
DUCATI	936	SUPERSPORT	2017	2019	FP004	N	DUCATI	1000	MONSTER S4R	2003	2008	FP003	N
DUCATI	939	HYPER MOTARD HYPERSTRADA 939	2016	2016	FP004	N	DUCATI	1000	MONSTER S2R	2006	2008	FP003	N
DUCATI	939	HYPER MOTARD 939 SP U	2016	2018	FP004	N	DUCATI	1000	MONSTER 1000 S	2005	2005	FP003	N
DUCATI	939	HYPER MOTARD 939 SP	2016	2018	FP004	N	DUCATI	1000	MONSTER 1000	2003	2005	FP003	N
DUCATI	939	HYPER MOTARD 939	2016	2018	FP004	N	DUCATI	1000	DESMOSEDICI RR	2008	2008	FP004	N
DUCATI	944	SPORT TOURING ST2	1997	2003	FP003	N	DUCATI	1098	1098	2007	2011	FP004	N
DUCATI	950	MULTISTRADA 950 TOURING	2017	2018	FP004	N	DUCATI	1100	STREETFIGHTER S	2010	2013	FP003	N
DUCATI	950	MULTISTRADA 950 SW	2018	2018	FP004	N	DUCATI	1100	STREETFIGHTER 1100	2009	2015	FP003	N
DUCATI	950	MULTISTRADA 950 S TOURING	2019	2020	FP004	N	DUCATI	1100	PANIGALE V4 SPECIALE	2018	2019	FP004	N
DUCATI	950	MULTISTRADA 950 S SW	2019	2020	FP004	N	DUCATI	1100	PANIGALE V4 S CORSE	2019	2019	FP004	N
DUCATI	950	MULTISTRADA 950 S	2019	2020	FP004	N	DUCATI	1100	PANIGALE V4 S	2018	2019	FP004	N
DUCATI	950	MULTISTRADA 950	2017	2019	FP004	N	DUCATI	1100	PANIGALE V4 R	2019	2019	FP004	N
DUCATI	950	HYPER MOTARD 950 SP U	2019	2019	FP004	N	DUCATI	1100	PANIGALE V4	2018	2019	FP004	N
DUCATI	950	HYPER MOTARD 950 SP	2019	2019	FP004	N	DUCATI	1100	MULTISTRADA 1100 S	2007	2009	FP003	N
DUCATI	950	HYPER MOTARD 950	2019	2019	FP004	N	DUCATI	1100	MULTISTRADA 1100	2007	2009	FP003	N
DUCATI	959	959 PANIGALE CORSE U	2019	2019	FP004	N	DUCATI	1100	MONSTER 1100 S ABS	2010	2010	FP003	N
DUCATI	959	959 PANIGALE CORSE	2018	2019	FP004	N	DUCATI	1100	MONSTER 1100 S	2009	2010	FP003	N
DUCATI	959	959 PANIGALE ABS	2016	2019	FP004	N	DUCATI	1100	MONSTER 1100 EVO ANNIVERSARY	2013	2013	FP004	N
DUCATI	996	SPORT TOURING ST4 S ABS	2003	2005	FP003	N	DUCATI	1100	MONSTER 1100 EVO ABS	2012	2013	FP004	N
DUCATI	996	SPORT TOURING ST4 S	2001	2005	FP003	N	DUCATI	1100	MONSTER 1100 DIESEL	2013	2013	FP004	N

BRAKE/CLUTCH
MASTER CYLINDERS
 ACCESSORIES
SPARE PARTS
 CNC-WORKED FLUID
RESERVOIR
 FULL CLUTCH
 HYDRAULIC-CLUTCH
TRANFORMATION KIT
 LEVER
 THROTTLE CONTROL
 BRAKE CALIPER
 RACING KIT
 BUTTON PANEL
 LEVER GUARD
 CLIP-ON
 STREET RACING
REARSET
 FUEL CAPS
 STEERING NUT
 CRASH PADS
 PADDOCK STAND
 MIRROR COVERS
 REAR-VIEW MIRRORS
 FOG LIGHTS KIT
 HANDLEBARS
ACCESSORIES
 HANDLEBARS

Marca Brand	CC	Modello Model	Dal From	Al To	Codice tappo olio Oil filter cap code	Novità New	Marca Brand	CC	Modello Model	Dal From	Al To	Codice tappo olio Oil filter cap code	Novità New
DUCATI	1100	MONSTER 1100 ABS	2010	2010	FP003	N	GUZZI	850	BREVA	2006	2007	FP001	N
DUCATI	1100	MONSTER 1100	2011	2013	FP004		GUZZI	1000	V10 CENTAURO	1997	1999	FP001	N
DUCATI	1100	MONSTER 1100	2009	2010	FP003	N	GUZZI	1000	MGS-01 CORSA	2004	2007	FP001	N
DUCATI	1100	HYPERMOTARD 1100 S ABS	2010	2010	FP003		GUZZI	1000	DAYTONA RS	1997	1998	FP001	N
DUCATI	1100	HYPERMOTARD 1100 S	2008	2009	FP003		GUZZI	1100	V11 SPORT	1999	2001	FP001	N
DUCATI	1100	HYPERMOTARD 1100 EVO	2010	2012	FP003		GUZZI	1100	V11 LE MANS, NAKED, SPORT	2003	2005	FP001	N
DUCATI	1100	HYPERMOTARD 1100 ABS	2010	2010	FP003		GUZZI	1100	V11 LE MANS, NAKED	2001	2001	FP001	N
DUCATI	1100	HYPERMOTARD 1100	2008	2010	FP003		GUZZI	1100	V11 LE MANS	2002	2002	FP001	N
DUCATI	1100	1098 S TRICOLORE	2007	2008	FP003	N	GUZZI	1100	V11 CAFE SPORT, BALLABIO, COPPA ITALIA	2003	2005	FP001	N
DUCATI	1100	1098 S	2007	2008	FP003	N	GUZZI	1100	SPORT CORSA	1998	1999	FP001	N
DUCATI	1198	1198	2007	2011	FP004		GUZZI	1100	SPORT 1100 INIEZIONE	1996	1999	FP001	N
DUCATI	1199	1199 PANIGALE	2012	2015	FP004		GUZZI	1100	GRISO 1100	2006	2015	FP001	
DUCATI	1200	MULTISTRADA 1200 S TOURING D-AIR	2014	2014	FP004	N	GUZZI	1100	BREVA	2005	2007	FP001	N
DUCATI	1200	MULTISTRADA 1200 S TOURING	2010	2014	FP004	N	GUZZI	1150	GRISO 1150	2006	2015	FP001	
DUCATI	1200	MULTISTRADA 1200 S SPORT	2011	2012	FP004	N	GUZZI	1200	STELVIO	2008	2008	FP001	N
DUCATI	1200	MULTISTRADA 1200 S PIKES PEAK	2012	2014	FP004	N	GUZZI	1200	SPORT 8V	2008	2013	FP001	N
DUCATI	1200	MULTISTRADA 1200 S GT	2013	2014	FP004	N	GUZZI	1200	SPORT	2006	2007	FP001	N
DUCATI	1200	MULTISTRADA 1200 S ABS	2010	2010	FP004	N	GUZZI	1200	NORGE 1200	2006	2008	FP001	N
DUCATI	1200	MULTISTRADA 1200 ABS	2010	2014	FP004	N	GUZZI	1200	GRISO 8V - 8V SPECIAL EDITION	2007	2013	FP001	N
DUCATI	1200	MULTISTRADA 1200	2010	2017	FP004		GUZZI	1200	BREVA	2007	2007	FP001	N
DUCATI	1200	MONSTER 1200 S STRIPES	2015	2016	FP004	N	HONDA	125	CBR125 R	2007	2016	FP004	N
DUCATI	1200	MONSTER 1200 S	2014	2017	FP004		HONDA	125	CB125 F	2015	2018	FP004	N
DUCATI	1200	MONSTER 1200	2014	2017	FP004		HONDA	250	CBR250 R	2011	2015	FP004	
DUCATI	1200	DIAVEL WHITE STRIPE	2013	2014	FP004	N	HONDA	300	CBR300 R	2015	2017	FP004	N
DUCATI	1200	DIAVEL TITANIUM	2015	2015	FP004	N	HONDA	300	CB300 F	2015	2018	FP004	N
DUCATI	1200	DIAVEL STRADA	2013	2014	FP004	N	HONDA	500	CMX 500 REBEL	2014	2018	FP004	N
DUCATI	1200	DIAVEL FL	2015	2018	FP004	N	HONDA	500	CBR500 R	2013	2018	FP004	N
DUCATI	1200	DIAVEL DIESEL	2017	2017	FP004	N	HONDA	500	CB500 X	2013	2018	FP004	N
DUCATI	1200	DIAVEL CROMO	2013	2013	FP004	N	HONDA	500	CB500 F	2013	2018	FP004	N
DUCATI	1200	DIAVEL CARBON FL	2015	2018	FP004	N	HONDA	600	XL600 V TRANSALP	1987	1993	FP004	N
DUCATI	1200	DIAVEL CARBON	2011	2013	FP004	N	HONDA	600	CBR600 RR	2003	2016	FP004	
DUCATI	1200	DIAVEL AMG	2013	2013	FP004	N	HONDA	600	CBR600 F	2011	2013	FP004	N
DUCATI	1200	DIAVEL	2011	2013	FP004	N	HONDA	600	CBR600 F	1995	2007	FP004	
DUCATI	1200	1199 PANIGALE SUPERLEGGERA	2014	2014	FP004	N	HONDA	600	CBF600 S	2008	2014	FP004	N
DUCATI	1200	1199 PANIGALE S TRICOLORE	2012	2013	FP004	N	HONDA	600	CBF600	2004	2014	FP004	N
DUCATI	1200	1199 PANIGALE S ABS	2012	2015	FP004	N	HONDA	600	CB600 F HORNET	2002	2015	FP004	N
DUCATI	1200	1199 PANIGALE S	2012	2013	FP004	N	HONDA	650	XL650 V TRANSALP	2000	2007	FP004	N
DUCATI	1200	1199 PANIGALE R	2013	2017	FP004	N	HONDA	650	NT650 V DEAUVILLE	1998	2005	FP004	N
DUCATI	1200	1199 PANIGALE ABS	2012	2014	FP004	N	HONDA	650	CBR650 F	2014	2016	FP004	N
DUCATI	1200	1198 SP	2011	2011	FP003	N	HONDA	650	CB650 F	2014	2018	FP004	N
DUCATI	1200	1198 S CORSE	2010	2010	FP003	N	HONDA	700	NT700 V DEAUVILLE	2006	2012	FP004	N
DUCATI	1200	1198 S	2009	2010	FP003	N	HONDA	700	INTEGRA 700	2012	2013	FP004	N
DUCATI	1200	1198 R	2010	2010	FP003	N	HONDA	750	X-ADV	2017	2018	FP004	N
DUCATI	1200	1098 R BAYLISS	2009	2009	FP003	N	HONDA	750	NC750 S/X	2014	2018	FP004	N
DUCATI	1200	1098 R	2008	2009	FP003	N	HONDA	750	INTEGRA 750	2014	2018	FP004	N
DUCATI	1299	PANIGALE 1299 / V4	2015	2018	FP004	N	HONDA	800	VFR800 F	2014	2018	FP004	N
DUCATI	1299	1299S ABS	2015	2017	FP004	N	HONDA	900	CBR900 RR FIRE BLADE	2000	2003	FP004	N
DUCATI	1299	1299 SUPERLEGGERA	2017	2017	FP004	N	HONDA	900	CBR900 RR	1994	2003	FP004	
DUCATI	1299	1299 S 90° ANNIVERSARIO	2000	2000	FP004	N	HONDA	1000	XL1000 V VARADERO	1999	2011	FP004	N
DUCATI	1299	1299 R FINAL EDITION	2018	2018	FP004	N	HONDA	1000	VTR1000 F FIRE STORM	1997	2007	FP004	N
DUCATI	1299	1299 ABS	2015	2017	FP004	N	HONDA	1000	VTR 1000 SP2	2000	2006	FP004	
GUZZI	850	NORGE 850	2007	2007	FP001	N	HONDA	1000	VTR 1000 SP1	2000	2006	FP004	
GUZZI	850	GRISO 850	2006	2015	FP001		HONDA	1000	VTR 1000 F	2000	2006	FP004	

- BRAKE/CLUTCH MASTER CYLINDERS
- ACCESSORIES SPARE PARTS
- CNC-WORKED FLUID RESERVOIR
- FULL CLUTCH
- HYDRAULIC-CLUTCH TRANFORMATION KIT
- LEVER
- THROTTLE CONTROL
- BRAKE CALIPER
- RACING KIT
- BUTTON PANEL
- LEVER GUARD
- CLIP-ON
- STREET RACING REARSET
- FUEL CAPS
- STEERING NUT
- CRASH PADS
- PADDOCK STAND
- MIRROR COVERS
- REAR-VIEW MIRRORS
- FOG LIGHTS KIT
- HANDLEBARS ACCESSORIES
- HANDLEBARS

Marca Brand	CC	Modello Model	Dal From	Al To	Codice tappo olio Oil filter cap code	Novità New	Marca Brand	CC	Modello Model	Dal From	Al To	Codice tappo olio Oil filter cap code	Novità New
HONDA	1000	CRF1000 L AFRICA TWIN	2016	2019	FP004	N	KAWASAKI	650	VULCAN S CAFE ABS	2017	2019	FP004	N
HONDA	1000	CBR1000 RR FIREBLADE/SP/SP2	2017	2018	FP004	N	KAWASAKI	650	VULCAN S ABS	2015	2018	FP004	N
HONDA	1000	CBR1000 RR FIREBLADE /SP	2014	2016	FP004	N	KAWASAKI	650	VULCAN S	2019	2020	FP004	N
HONDA	1000	CBR1000 RR FIREBLADE	2004	2013	FP004	N	KAWASAKI	650	VULCAN S	2015	2016	FP004	N
HONDA	1000	CBR1000 RR	2017	2019	FP004	N	KAWASAKI	650	NINJA 650 ABS	2017	2019	FP004	N
HONDA	1000	CBF1000	2006	2011	FP004	N	KAWASAKI	650	KLX650 R	1996	2001	FP004	N
HONDA	1000	CB1000 R NEO SPORTS CAFE	2018	2018	FP004	N	KAWASAKI	650	KLX650	1993	1995	FP004	N
HONDA	1000	CB1000 R	2008	2017	FP004	N	KAWASAKI	650	KLR 650	1995	2004	FP005	N
HONDA	1100	CB1100 RS	2017	2018	FP004	N	KAWASAKI	650	KLE VERSYS 650 ABS	2007	2018	FP004	N
HONDA	1100	CB1100 EX	2014	2018	FP004	N	KAWASAKI	650	KLE VERSYS 650	2019	2020	FP004	N
HONDA	1100	CB1100	2013	2014	FP004	N	KAWASAKI	650	KLE VERSYS 650	2006	2018	FP004	N
HONDA	1200	VFR1200 F	2010	2016	FP004	N	KAWASAKI	650	KL 650 TENGA	1989	1991	FP005	N
HONDA	1200	CROSSTOURER	2012	2018	FP004	N	KAWASAKI	650	KL 650	1987	1989	FP005	N
KAWASAKI	110	KLX	2002	2020	FP005	N	KAWASAKI	650	ER-6 N ABS	2006	2016	FP004	N
KAWASAKI	125	Z125	2019	2020	FP004	N	KAWASAKI	650	ER-6 N	2006	2016	FP004	N
KAWASAKI	125	NINJA 125	2019	2020	FP004	N	KAWASAKI	650	ER-6 F ABS	2006	2016	FP004	N
KAWASAKI	220	KLF 220	1992	2002	FP005	N	KAWASAKI	650	ER-6 F	2006	2016	FP004	N
KAWASAKI	230	KLX230	2020	2020	FP004	N	KAWASAKI	650	EJ 650 (W650)	1999	2006	FP005	N
KAWASAKI	250	ZZR 250	1996	2003	FP005	N	KAWASAKI	750	ZXR750 H2 STINGER	1990	1990	FP004	N
KAWASAKI	250	Z250 SL ABS	2017	2017	FP004	N	KAWASAKI	750	ZXR750 H1 STINGER	1989	1989	FP004	N
KAWASAKI	250	Z250 SL	2015	2016	FP004	N	KAWASAKI	750	ZX R750 R	1991	1995	FP004	N
KAWASAKI	250	NINJA 250 SL	2015	2016	FP004	N	KAWASAKI	750	ZR-7 S	2001	2003	FP005	N
KAWASAKI	250	NINJA 250 R	2008	2012	FP005	N	KAWASAKI	750	ZR-7	1999	2003	FP005	N
KAWASAKI	250	KSF 250	1996	2000	FP005	N	KAWASAKI	750	Z750 S	2005	2006	FP005	N
KAWASAKI	250	KLX250	2009	2017	FP004	N	KAWASAKI	750	Z750 R ABS	2011	2012	FP005	N
KAWASAKI	250	KLR 250	1987	1989	FP005	N	KAWASAKI	750	Z750 R	2011	2012	FP005	N
KAWASAKI	300	Z300 ABS	2017	2018	FP005	N	KAWASAKI	750	Z750 ABS	2007	2012	FP005	N
KAWASAKI	300	Z300	2015	2016	FP005	N	KAWASAKI	750	Z750	2004	2012	FP005	N
KAWASAKI	300	NINJA 300 ABS	2013	2016	FP005	N	KAWASAKI	750	NINJA ZX-7 R	1996	2002	FP005	N
KAWASAKI	300	NINJA 300	2013	2016	FP005	N	KAWASAKI	750	GPX 750 R	1987	1989	FP005	N
KAWASAKI	300	KLX300	1997	2003	FP004	N	KAWASAKI	800	Z800 E SPECIAL EDITION	2016	2016	FP004	N
KAWASAKI	300	KLF 300 4X4	1998	2002	FP005	N	KAWASAKI	800	Z800 E ABS SPECIAL EDITION	2016	2016	FP004	N
KAWASAKI	300	KLF 300	1997	2001	FP005	N	KAWASAKI	800	Z800 E ABS	2013	2016	FP004	N
KAWASAKI	300	KLE VERSYS	2017	2020	FP005	N	KAWASAKI	800	Z800 E	2013	2016	FP004	N
KAWASAKI	400	ZXR400	1990	1999	FP005	N	KAWASAKI	800	Z800 ABS	2013	2016	FP004	N
KAWASAKI	400	Z400	2019	2019	FP004	N	KAWASAKI	800	Z800	2013	2016	FP004	N
KAWASAKI	400	NINJA 400	2018	2020	FP004	N	KAWASAKI	800	EJ 800 (W800)	2011	2016	FP005	N
KAWASAKI	400	KLF 400 4X4	1996	1999	FP005	N	KAWASAKI	800	EJ 800 (W800 STREET)	2019	2019	FP005	N
KAWASAKI	500	KLE 500	1991	2007	FP005	N	KAWASAKI	800	EJ 800 (W800 CAFE)	2019	2020	FP005	N
KAWASAKI	500	GPZ 500 S	1987	2003	FP005	N	KAWASAKI	900	Z900 RS CAFE	2018	2020	FP004	N
KAWASAKI	550	GPZ 550	1984	1985	FP005	N	KAWASAKI	900	Z900 RS	2018	2020	FP004	N
KAWASAKI	600	ZZR 600	1990	2006	FP005	N	KAWASAKI	900	Z900 ABS	2017	2017	FP004	N
KAWASAKI	600	ZL ELIMINATOR	1995	1997	FP005	N	KAWASAKI	900	Z900	2017	2019	FP004	N
KAWASAKI	600	NINJA ZX-6 RR	2003	2005	FP005	N	KAWASAKI	900	VN VULCAN CUSTOM	2012	2016	FP005	N
KAWASAKI	600	NINJA ZX-6 R F1-F3 G1-G2 J1P-J2P	1995	2001	FP005	N	KAWASAKI	900	VN VULCAN CLASSIC	2015	2016	FP005	N
KAWASAKI	600	NINJA ZX-6 R 600	2007	2016	FP005	N	KAWASAKI	900	VN CUSTOM	2007	2011	FP005	N
KAWASAKI	600	KLR 600	1991	1994	FP005	N	KAWASAKI	900	VN CLASSIC	2011	2014	FP005	N
KAWASAKI	600	GPZ 600 R	1987	1988	FP005	N	KAWASAKI	900	NINJA ZX-9 R	1998	2005	FP005	N
KAWASAKI	600	GPX 600 R	1988	1990	FP005	N	KAWASAKI	900	NINJA ZX-9 R	1994	1997	FP004	N
KAWASAKI	636	NINJA ZX-6 R AP1	2002	2002	FP005	N	KAWASAKI	1000	ZX 10	1988	1990	FP005	N
KAWASAKI	636	NINJA ZX-6 R ABS	2013	2017	FP005	N	KAWASAKI	1000	Z1000 SX	2010	2018	FP004	N
KAWASAKI	636	NINJA ZX-6 R 636	2002	2019	FP005	N	KAWASAKI	1000	Z1000 SX	2007	2009	FP005	N
KAWASAKI	650	Z650	2017	2019	FP004	N	KAWASAKI	1000	Z1000 R EDITION	2017	2020	FP004	N

BRAKE/CLUTCH
 MASTER CYLINDERS
 ACCESSORIES
 SPARE PARTS
 CNC-WORKED FLUID
 RESERVOIR
 FULL CLUTCH
 HYDRAULIC-CLUTCH
 TRANFORMATION KIT
 LEVER
 THROTTLE CONTROL
 BRAKE CALIPER
 RACING KIT
 BUTTON PANEL
 LEVER GUARD
 CLIP-ON
 STREET RACING
 REARSET
 FUEL CAPS
 STEERING NUT
 CRASH PADS
 PADDOCK STAND
 MIRROR COVERS
 REAR-VIEW MIRRORS
 FOG LIGHTS KIT
 HANDLEBARS
 ACCESSORIES
 HANDLEBARS

Marca Brand	CC	Modello Model	Dal From	Al To	Codice tappo olio Oil filter cap code	Novità New	Marca Brand	CC	Modello Model	Dal From	Al To	Codice tappo olio Oil filter cap code	Novità New
KAWASAKI	1000	Z1000 ABS	2010	2020	FP004	N	SUZUKI	85	RM 85 L	2016	2019	FP001	N
KAWASAKI	1000	Z1000 ABS	2007	2009	FP005	N	SUZUKI	85	RM 85	2002	2010	FP001	N
KAWASAKI	1000	Z1000	2011	2018	FP004	N	SUZUKI	125	VL INTRUDER 125	2005	2007	FP001	N
KAWASAKI	1000	Z1000	2003	2009	FP005	N	SUZUKI	125	UX 125 SIXTEEN	2008	2011	FP001	N
KAWASAKI	1000	NINJA ZX-10 RR	2017	2018	FP005	N	SUZUKI	125	RV 125 VAN VAN	2003	2015	FP001	N
KAWASAKI	1000	NINJA ZX-10 R SE	2018	2019	FP005	N	SUZUKI	125	RM 125	2001	2008	FP001	N
KAWASAKI	1000	NINJA ZX-10 R ABS	2011	2018	FP005	N	SUZUKI	125	DR-Z125 LM	2020	2020	FP001	N
KAWASAKI	1000	NINJA ZX-10 R	2004	2019	FP005	N	SUZUKI	125	DR-Z125 L	2016	2017	FP001	N
KAWASAKI	1000	NINJA H2 SX SE+	2019	2019	FP005	N	SUZUKI	125	DR-Z	2008	2010	FP001	N
KAWASAKI	1000	NINJA H2 SX SE	2018	2019	FP005	N	SUZUKI	125	DR SM	2009	2010	FP001	N
KAWASAKI	1000	NINJA H2 SX	2018	2019	FP005	N	SUZUKI	150	UX 150 SIXTEEN	2008	2011	FP001	N
KAWASAKI	1000	KLZ VERSYS 1000	2012	2019	FP004	N	SUZUKI	200	RV 200 VAN VAN	2016	2016	FP001	N
KAWASAKI	1000	GTR 1000 ABS	2008	2009	FP005	N	SUZUKI	250	VL INTRUDER 250	2005	2007	FP001	N
KAWASAKI	1000	GTR 1000 A18	2003	2003	FP005	N	SUZUKI	250	RM 250	2001	2008	FP001	N
KAWASAKI	1000	GTR 1000 A11	1996	1997	FP005	N	SUZUKI	250	RGV 250 GAMMA	1991	1996	FP001	N
KAWASAKI	1000	GPZ 1000 RX	1986	1988	FP005	N	SUZUKI	400	AN400 BURGMAN	2007	2019	FP001	N
KAWASAKI	1100	ZZR 1100 D7	1999	1999	FP005	N	SUZUKI	600	GSX-R600	2004	2017	FP001	N
KAWASAKI	1100	ZZR 1100	1990	1996	FP005	N	SUZUKI	600	GSX 600 F	1998	2006	FP001	N
KAWASAKI	1100	ZRX 1100	1997	1999	FP005	N	SUZUKI	600	GSR 600	2006	2010	FP001	N
KAWASAKI	1100	GPZ 1100	1995	1997	FP005	N	SUZUKI	600	GSF 600 BANDIT	2000	2004	FP001	N
KAWASAKI	1200	ZZR 1200 C4H	2005	2005	FP005	N	SUZUKI	650	SV 650 XA	2018	2018	FP001	N
KAWASAKI	1200	ZZR 1200	2002	2003	FP005	N	SUZUKI	650	SV 650 SL5	2015	2015	FP001	N
KAWASAKI	1200	ZRX 1200 S	2001	2004	FP005	N	SUZUKI	650	SV 650 A	2017	2019	FP001	N
KAWASAKI	1200	ZRX 1200 R	2001	2006	FP005	N	SUZUKI	650	SV 650	2003	2010	FP001	N
KAWASAKI	1200	ZRX 1200	2001	2004	FP005	N	SUZUKI	650	SFV 650 GALDIUS	2009	2015	FP001	N
KAWASAKI	1200	NINJA ZX-12 R	2000	2006	FP005	N	SUZUKI	650	GSX 650 F	2008	2012	FP001	N
KAWASAKI	1400	ZZR 1400 ABS	2006	2020	FP005	N	SUZUKI	650	GSF 650 BANDIT	2005	2012	FP001	N
KAWASAKI	1400	ZZR 1400	2006	2007	FP005	N	SUZUKI	650	DL650 XT V-STROM ABS	2015	2015	FP001	N
KAWASAKI	1400	GTR 1400 ABS	2015	2018	FP005	N	SUZUKI	650	DL650 V-STROM ABS	2013	2015	FP001	N
KAWASAKI	1400	GTR 1400	2008	2014	FP005	N	SUZUKI	650	DL650 V-STROM	2004	2012	FP001	N
MV AGUSTA	750	F4 750	2000	2017	FP009	N	SUZUKI	650	DL650 A/XA V-STROM	2016	2019	FP001	N
MV AGUSTA	750	BRUTALE 750	2000	2017	FP009	N	SUZUKI	650	AN650 Z BURGMAN	2018	2018	FP001	N
MV AGUSTA	910	F4 910	2000	2017	FP009	N	SUZUKI	650	AN650 BURGMAN	2003	2016	FP001	N
MV AGUSTA	910	BRUTALE 910	2000	2017	FP009	N	SUZUKI	750	GSX-S750	2017	2019	FP001	N
MV AGUSTA	920	BRUTALE 920	2010	2011	FP009	N	SUZUKI	750	GSX-R750	2004	2017	FP001	N
MV AGUSTA	989	BRUTALE 989 R	2008	2008	FP009	N	SUZUKI	750	GSX-750 Z	2014	2014	FP001	N
MV AGUSTA	990	F4 990	2000	2017	FP009	N	SUZUKI	750	GSX 750 F	1998	2006	FP001	N
MV AGUSTA	990	BRUTALE 990 R	2010	2011	FP009	N	SUZUKI	750	GSR 750	2011	2016	FP001	N
MV AGUSTA	990	BRUTALE 990	2000	2017	FP009	N	SUZUKI	800	VZ INTRUDER M800	2005	2016	FP001	N
MV AGUSTA	1000	F4 1000 VELTRO	2008	2008	FP009	N	SUZUKI	800	VL INTRUDER C800	2006	2013	FP001	N
MV AGUSTA	1000	F4 1000 S	2010	2012	FP009	N	SUZUKI	800	VL INTRUDER 800 VOLUSIA	2001	2005	FP001	N
MV AGUSTA	1000	F4 1000 RR	2010	2012	FP009	N	SUZUKI	800	VL 800 INTRUDER	2014	2014	FP001	N
MV AGUSTA	1000	F4 1000 R	2006	2012	FP009	N	SUZUKI	800	VL 800	2014	2014	FP001	N
MV AGUSTA	1000	F4 1000 FRECCHE TRICOLORE	2010	2012	FP009	N	SUZUKI	1000	SV 1000	2003	2007	FP001	N
MV AGUSTA	1000	F4 1000 312 R	2007	2008	FP009	N	SUZUKI	1000	GSX-S 1000	2016	2019	FP001	N
MV AGUSTA	1000	F4 1000	2004	2006	FP009	N	SUZUKI	1000	GSX-R 1000 Z	2014	2014	FP001	N
MV AGUSTA	1078	F4 1078 312 RR	2007	2008	FP009	N	SUZUKI	1000	GSX-R 1000	2003	2019	FP001	N
MV AGUSTA	1078	F4 1000 CC	2007	2007	FP009	N	SUZUKI	1000	DL 1000 V-STROM K2-L0	2002	2010	FP001	N
MV AGUSTA	1078	BRUTALE 1078 R	2008	2008	FP009	N	SUZUKI	1000	DL 1000 V-STROM	2014	2016	FP001	N
MV AGUSTA	1090	F4 1090	2000	2018	FP009	N	SUZUKI	1000	DL 1000 A V-STROM	2018	2019	FP001	N
MV AGUSTA	1090	BRUTALE 1090 RR	2010	2015	FP009	N	SUZUKI	1200	GSF 1200 BANDIT	2001	2006	FP001	N
MV AGUSTA	1090	BRUTALE 1090 R	2013	2015	FP009	N	SUZUKI	1250	GSX 1250 FA	2010	2016	FP001	N
MV AGUSTA	1090	BRUTALE 1090 CORSA	2013	2015	FP009	N	SUZUKI	1250	GSF 1250 SA BANDIT	2015	2016	FP001	N
MV AGUSTA	1090	BRUTALE 1090	2000	2017	FP009	N	SUZUKI	1250	GSF 1250 S BANDIT	2011	2012	FP001	N

BRAKE/CLUTCH
 MASTER CYLINDERS
 ACCESSORIES
 SPARE PARTS
 CNC-WORKED FLUID
 RESERVOIR
 FULL CLUTCH
 HYDRAULIC-CLUTCH
 TRANFORMATION KIT
 LEVER
 THROTTLE CONTROL
 BRAKE CALIPER
 RACING KIT
 BUTTON PANEL
 LEVER GUARD
 CLIP-ON
 STREET RACING
 REARSET
 FUEL CAPS
 STEERING NUT
 CRASH PADS
 PADDOCK STAND
 MIRROR COVERS
 REAR-VIEW MIRRORS
 FOG LIGHTS KIT
 HANDLEBARS
 ACCESSORIES
 HANDLEBARS

Marca Brand	CC	Modello Model	Dal From	Al To	Codice tappo olio Oil filter cap code	Novità New	Marca Brand	CC	Modello Model	Dal From	Al To	Codice tappo olio Oil filter cap code	Novità New
SUZUKI	1250	GSF 1250 BANDIT	2007	2011	FP001	N	YAMAHA	600	FZR 600	1989	1993	FP006	N
SUZUKI	1300	GSZ 1300 R HAYABUSA	1999	2013	FP001	N	YAMAHA	600	FZ6 S2	2007	2008	FP006	N
SUZUKI	1300	GSX 1300 RA HAYABUSA	2008	2017	FP001	N	YAMAHA	600	FZ6 NS	2005	2006	FP006	N
SUZUKI	1300	GSX 1300 BK B-KING	2008	2010	FP001	N	YAMAHA	600	FZ6 FAZER S2 ABS	2008	2008	FP006	N
SUZUKI	1400	GSX 1400	2002	2007	FP001	N	YAMAHA	600	FZ6 FAZER S2	2007	2008	FP006	N
SUZUKI	1500	VL INTRUDER 1500	2005	2008	FP001	N	YAMAHA	600	FZ6 FAZER ABS	2006	2007	FP006	N
TRIUMPH	675	STREET TRIPLE 675	2013	2017	FP004		YAMAHA	600	FZ6 FAZER	2004	2007	FP006	N
TRIUMPH	675	DAYTONA 675 R	2014	2015	FP004		YAMAHA	600	FZ6	2005	2008	FP006	
TRIUMPH	765	STREET TRIPLE 765 RS	2017	2019	FP004	N	YAMAHA	600	FAZER 600 S2 ABS	2008	2008	FP006	N
TRIUMPH	955	SPEED TRIPLE 955	2005	2015	FP004		YAMAHA	600	FAZER 600 S2	2007	2008	FP006	N
TRIUMPH	1050	SPEED TRIPLE 1050	2005	2015	FP004		YAMAHA	600	FAZER 600 ABS	2006	2007	FP006	N
YAMAHA	125	R125	2008	2018	FP004	N	YAMAHA	600	FAZER 600	2004	2007	FP006	
YAMAHA	300	R300 / R320	2017	2018	FP006	N	YAMAHA	650	XVS 650 DRAG STAR	1997	2002	FP006	N
YAMAHA	320	YZF-R3	2015	2018	FP006	N	YAMAHA	650	XVS 650 A DRAG STAR CLASSIC	1998	2006	FP006	N
YAMAHA	321	MT-03 321	2016	2018	FP006	N	YAMAHA	660	SZR	1995	1997	FP004	N
YAMAHA	500	T-MAX WHITE MAX	2010	2010	FP004	N	YAMAHA	660	MT-03 660	2006	2014	FP004	
YAMAHA	500	T-MAX SV	2011	2011	FP004	N	YAMAHA	700	XSR 700	2016	2018	FP006	N
YAMAHA	500	T-MAX 500 NIGHT MAX	2007	2007	FP004	N	YAMAHA	700	XMT-07	2014	2018	FP006	N
YAMAHA	500	T-MAX 500 BLACK MAX	2006	2007	FP004	N	YAMAHA	700	MTM 690 TRACER	2016	2018	FP006	N
YAMAHA	500	T-MAX 500 ABS SV	2010	2011	FP004	N	YAMAHA	700	MTM 690	2018	2019	FP006	N
YAMAHA	500	T-MAX 500 ABS	2005	2011	FP004	N	YAMAHA	700	MT-07 MC MOTO CAGE	2014	2014	FP006	N
YAMAHA	500	TMAX 500	2008	2018	FP004	N	YAMAHA	700	MT-07 ABS	2014	2019	FP006	N
YAMAHA	530	XP530E-A T-MAX	2017	2018	FP004	N	YAMAHA	700	MT-07	2014	2019	FP006	N
YAMAHA	530	XP530D-A T-MAX DX	2017	2019	FP004	N	YAMAHA	750	YZF-R7	1999	2000	FP006	
YAMAHA	530	XP530-A T-MAX SX	2017	2019	FP004	N	YAMAHA	750	YZF 750 SP	1993	1995	FP006	
YAMAHA	530	T-MAX SP ABS	2015	2016	FP004	N	YAMAHA	750	YZF 750 R THUNDER CAT	1996	2002	FP006	N
YAMAHA	530	T-MAX SP	2015	2015	FP004	N	YAMAHA	750	YZF 750 R	1993	1996	FP006	
YAMAHA	530	T-MAX 530 ABS	2012	2016	FP004	N	YAMAHA	750	FZ 750	1989	1990	FP006	N
YAMAHA	530	TMAX 530	2008	2018	FP004	N	YAMAHA	800	FZ8	2010	2016	FP006	
YAMAHA	535	XV 535 VIRAGO	1989	1998	FP006	N	YAMAHA	850	XSR900	2016	2020	FP004	N
YAMAHA	535	XV 535 SE VIRAGO	1988	1988	FP006	N	YAMAHA	850	TRX 850	1996	1997	FP006	N
YAMAHA	535	XV 535 DX VIRAGO	1999	2001	FP006	N	YAMAHA	850	TDM 850	1996	2001	FP006	N
YAMAHA	550	XV 550	1982	1985	FP006	N	YAMAHA	850	MTX 850 NIKEN	2018	2018	FP004	N
YAMAHA	600	YZF-R6	2007	2020	FP006	N	YAMAHA	850	MTX 850 D NIKEN GT	2019	2019	FP004	N
YAMAHA	600	YZF-R6	1999	2005	FP006	N	YAMAHA	850	MTT 850 D TRACER GT	2019	2019	FP004	N
YAMAHA	600	YZF-R46	2005	2005	FP006	N	YAMAHA	850	MT-09 TRACER GT	2018	2019	FP004	N
YAMAHA	600	YZF R6 50TH	2012	2012	FP006	N	YAMAHA	850	MT-09 TRACER	2013	2020	FP004	N
YAMAHA	600	YZF R6 & LIMITED EDITION 07	2006	2006	FP006	N	YAMAHA	850	MT-09 SP	2018	2020	FP004	N
YAMAHA	600	XJ6-S DIVERSION ABS	2013	2015	FP006	N	YAMAHA	850	MT-09 ABS	2014	2020	FP004	N
YAMAHA	600	XJ6-S DIVERSION	2009	2015	FP006	N	YAMAHA	850	MT-09	2013	2020	FP004	N
YAMAHA	600	XJ6-NA ABS	2011	2015	FP006	N	YAMAHA	900	XJ 900 S DIVERSION	1995	2001	FP006	N
YAMAHA	600	XJ6-N SP	2013	2013	FP006	N	YAMAHA	1000	YZF-R1M	2015	2018	FP006	N
YAMAHA	600	XJ6-N	2009	2013	FP006	N	YAMAHA	1000	YZF-R1	2007	2018	FP006	N
YAMAHA	600	XJ6-FA DIVERSION ABS	2010	2011	FP006	N	YAMAHA	1000	YZF-R1	1998	2003	FP006	N
YAMAHA	600	XJ6-F DIVERSION	2010	2011	FP006	N	YAMAHA	1000	YZF 1000 R THUNDER ACE	1996	1998	FP006	
YAMAHA	600	XJ6	2009	2015	FP006	N	YAMAHA	1000	MT-10	2016	2018	FP006	N
YAMAHA	600	XJ 600 S DIVERSION	1992	2002	FP006	N	YAMAHA	1000	GTS A (ABS)	1993	1993	FP006	N
YAMAHA	600	XJ 600 N	1995	2001	FP006	N	YAMAHA	1000	GTS 1000 / GTS 1000 ABS	1993	1993	FP006	N
YAMAHA	600	XJ 600 FA DIVERSION ABS	2010	2011	FP006	N	YAMAHA	1000	GTS	1993	1993	FP006	N
YAMAHA	600	XJ 600 F DIVERSION	2010	2011	FP006	N	YAMAHA	1000	FZS 1000 FAZER	2001	2005	FP006	N
YAMAHA	600	TT 600 RE	2004	2004	FP004	N	YAMAHA	1000	FZR 1000	1989	1995	FP006	
YAMAHA	600	TT 600 R	1998	2002	FP004	N	YAMAHA	1000	FZ1 NA	2010	2011	FP006	N
YAMAHA	600	FZS 600 FAZER	1998	2003	FP006	N	YAMAHA	1000	FZ1 N	2011	2011	FP006	N
YAMAHA	600	FZR 600 R	1994	1995	FP006	N	YAMAHA	1000	FZ1 FAZER ABS	2007	2012	FP006	N

BRAKE/CLUTCH
 MASTER CYLINDERS
 ACCESSORIES
 SPARE PARTS
 CNC-WORKED FLUID
 RESERVOIR
 FULL CLUTCH
 HYDRAULIC-CLUTCH
 TRANFORMATION KIT
 LEVER
 THROTTLE CONTROL
 BRAKE CALIPER
 RACING KIT
 BUTTON PANEL
 LEVER GUARD
 CLIP-ON
 STREET RACING
 REARSET
 FUEL CAPS
 STEERING NUT
 CRASH PADS
 PADDOCK STAND
 MIRROR COVERS
 REAR-VIEW MIRRORS
 FOG LIGHTS KIT
 HANDLEBARS
 ACCESSORIES
 HANDLEBARS

Marca Brand	CC	Modello Model	Dal From	Al To	Codice tappo olio Oil filter cap code	Novità New
YAMAHA	1000	FZ1 FAZER	2006	2012	FP006	
YAMAHA	1000	FZ1	2006	2015	FP006	
YAMAHA	1100	XVS 1100 DRAG STAR	1999	2002	FP006	N
YAMAHA	1100	XVS 1100 A DRAG STAR CLASSIC	2006	2006	FP006	N
YAMAHA	1100	XVS 1100 A DRAG STAR CLASSIC	2000	2003	FP006	N
YAMAHA	1100	BT BULLDOG	2002	2006	FP006	N
YAMAHA	1200	XT 1200 ZE SUPER TENERE	2014	2019	FP006	N
YAMAHA	1200	XT 1200 Z SUPER TENERE	2010	2019	FP006	N
YAMAHA	1200	XJR 1200	1995	1997	FP006	N
YAMAHA	1200	FJ 1200	1991	1992	FP006	N
YAMAHA	1300	XVS 1300 CU CUSTOM	2014	2016	FP006	N
YAMAHA	1300	XVS 1300 A MIDNIGHT STAR	2011	2016	FP006	N
YAMAHA	1300	XVS 1300 A MIDNIGHT STAR	2007	2008	FP006	N
YAMAHA	1300	FJR 1300 AS	2007	2018	FP006	N
YAMAHA	1300	FJR 1300 AE	2014	2018	FP006	N
YAMAHA	1300	FJR 1300 A ABS	2003	2015	FP006	N
YAMAHA	1300	FJR 1300 A	2016	2018	FP006	N
YAMAHA	1300	FJR 1300	2001	2004	FP006	N
YAMAHA	1300	XVS 1300 CU CUSTOM	2014	2016	FP006	N

BRAKE/CLUTCH
MASTER CYLINDERS

ACCESSORIES
SPARE PARTS

CNC-WORKED FLUID
RESERVOIR

FULL CLUTCH

HYDRAULIC-CLUTCH
TRANFORMATION KIT

LEVER

THROTTLE CONTROL

BRAKE CALIPER

RACING KIT

BUTTON PANEL

LEVER GUARD

CLIP-ON

STREET RACING
REARSET

FUEL CAPS

STEERING NUT

CRASH PADS

PADDOCK STAND

MIRROR COVERS

REAR-VIEW MIRRORS

FOG LIGHTS KIT

HANDLEBARS
ACCESSORIES

HANDLEBARS

GHIERE DI STERZO

STEERING NUT



Colori ghiere / Colours steering nut

N ●
nero - black

Y ●
oro - gold

B ●
blu - blue

R ●
rosso - red

S ●
argento - silver

G ●
verde - green

T ●
titanio - titanium

BRAKE/CLUTCH
MASTER CYLINDERS

ACCESSORIES
SPARE PARTS

CNC-WORKED FLUID
RESERVOIR

FULL CLUTCH

HYDRAULIC-CLUTCH
TRANSFORMATION KIT

LEVER

THROTTLE CONTROL

BRAKE CALIPER

RACING KIT

BUTTON PANEL

LEVER GUARD

CLIP-ON

STREET RACING
REARSET

FUEL CAPS

STEERING NUT

CRASH PADS

Paddock STAND

MIRROR COVERS

REAR-VIEW MIRRORS

FOG LIGHTS KIT

HANDLEBARS
ACCESSORIES

HANDLEBARS

Applicazioni / Application list

Marca Brand	CC	Modello Model	Dal From	Al To	Codice ghiera aperta Open steering nut code	Codice ghiera chiusa Closed steering nut code	Novità New	Marca Brand	CC	Modello Model	Dal From	Al To	Codice ghiera aperta Open steering nut code	Codice ghiera chiusa Closed steering nut code	Novità New
BMW	1000	S1000 RR	2009	2017	SA001	SC001		SUZUKI	1000	GSX-R 1000	2001	2002	SA009	SC009	N
GUZZI	750	V7 III STONE / SPECIAL	2017	2019	SA006	SC006	N	SUZUKI	1000	DL 1000 V-STROM	2014	2016	SA009	SC009	N
GUZZI	750	V7 ROUGH / CABON / LIMITED	2018	2019	SA006	SC006	N	SUZUKI	1000	DL 1000 X V-STROM	2018	2019	SA009	SC009	N
GUZZI	850	BREVA	2006	2007	SA006	SC006	N	SUZUKI	1000	SV 1000	2003	2007	SA009	SC009	N
GUZZI	850	V9 BOBBER	2016	2018	SA006	SC006	N	SUZUKI	1200	GSF 1200 BANDIT	2001	2006	SA008	SC008	N
GUZZI	850	V9 ROAMER	2016	2018	SA006	SC006	N	SUZUKI	1250	GSF 1250 BANDIT	2007	2016	SA008	SC008	N
GUZZI	850	V85 TT	2019	2019	SA006	SC006	N	SUZUKI	1300	GSX-R 1300 HAYABUSA	2008	2017	SA009	SC009	N
GUZZI	1100	BREVA	2005	2007	SA006	SC006	N	SUZUKI	1300	B-KING	2007	2012	SA009	SC009	N
GUZZI	1200	BREVA	2007	2007	SA006	SC006	N	SUZUKI	1800	VZR INTRUDER M1800	2006	2012	SA008	SC008	N
GUZZI	1200	STELVIO	2008	2017	SA006	SC006	N	TRIUMPH	675	DAYTONA675	2007	2015	SA005	SC005	
GUZZI	1400	AUDACE	2015	2017	SA006	SC006	N	TRIUMPH	675	STREET TRIPLE / R	2007	2017	SA005	SC005	N
GUZZI	1400	ELDORADO	2015	2017	SA006	SC006	N	YAMAHA	125	R 125	2008	2018	SA008	SC008	N
HONDA	250	CBR 250 R	2011	2014	SA005	SC005		YAMAHA	500	XP T-MAX	2008	2011	SA001	SC001	N
HONDA	600	CBR 600 F	2011	2013	SA005	SC005		YAMAHA	500	XP T-MAX ABS	2008	2011	SA001	SC001	N
HONDA	600	CBR 600 RR	2005	2016	SA005	SC005		YAMAHA	500	XP T-MAX ABS SV	2010	2011	SA001	SC001	N
HONDA	600	HORNET 600	2003	2009	SA005	SC005		YAMAHA	500	SP T-MAX SV	2011	2011	SA001	SC001	N
HONDA	900	HORNET 900	2002	2009	SA005	SC005		YAMAHA	500	XP T-MAX WHITE MAX	2010	2010	SA001	SC001	N
HONDA	900	CBR 900 RR	2002	2003	SA005	SC005		YAMAHA	530	XP T-MAX	2012	2016	SA001	SC001	N
HONDA	1000	CB 1000 R	2008	2017	SA005	SC005	N	YAMAHA	530	XP T-MAX ABS	2012	2016	SA001	SC001	N
HONDA	1000	CBR 1000 R	2008	2017	SA005	SC005		YAMAHA	530	XP530-A T-MAX SX	2017	2019	SA001	SC001	N
HONDA	1000	CBR 1000 RR	2008	2011	SA011	SC011	N	YAMAHA	530	XP530D-A T-MAX DX	2017	2019	SA001	SC001	N
HONDA	1000	CBR 1000 RR	2017	2018	SA011	SC011	N	YAMAHA	530	XP530E-A T-MAX	2017	2018	SA001	SC001	N
KAWASAKI	400	NINJA 400	2006	2018	SA010	SC010	N	YAMAHA	600	YZF-R6	2006	2017	SA001	SC001	
KAWASAKI	600	ZX-6 R	2005	2019	SA001	SC001		YAMAHA	600	YZF-R46	2005	2005	SA001	SC001	N
KAWASAKI	636	ZX-6 R / RR	2006	2018	SA001	SC001	N	YAMAHA	600	YZF-R6 LIMITED EDITION 07	2006	2006	SA001	SC001	N
KAWASAKI	636	ZX-6 R / RR	1998	2002	SA008	SC008	N	YAMAHA	600	YZF-R6 50TH	2012	2012	SA001	SC001	N
KAWASAKI	636	ZX-6 R / RR	2003	2004	SA010	SC010	N	YAMAHA	600	XJ-6	2009	2015	SA008	SC008	N
KAWASAKI	900	ZX-9 R	1998	2005	SA008	SC008	N	YAMAHA	600	FZ6	2004	2011	SA008	SC008	N
KAWASAKI	1000	ZX-10R	2004	2019	SA001	SC001		YAMAHA	750	YZF-R7 OW02	1999	2000	SA001	SC001	N
KAWASAKI	1000	NINJA H2	2018	2019	SA001	SC001	N	YAMAHA	800	FZ8-N	2010	2016	SA001	SC001	N
KAWASAKI	1400	ZZR 1400 R	2006	2018	SA010	SC010	N	YAMAHA	800	FZ8-NA	2010	2016	SA001	SC001	N
KTM	790	DUKE 790	2018	2019	SA007	SC007	N	YAMAHA	800	FZ8-S	2010	2016	SA001	SC001	N
SUZUKI	125	DR 125	1997	1995	SA008	SC008	N	YAMAHA	800	FZ8-SA	2010	2016	SA001	SC001	N
SUZUKI	350	DR 350	1990	1998	SA008	SC008	N	YAMAHA	850	MT-09	2013	2019	SA008	SC008	N
SUZUKI	400	GSF 400 BANDIT	1991	1993	SA008	SC008	N	YAMAHA	850	MT-09 TRACER	2015	2019	SA008	SC008	N
SUZUKI	600	GSX-R600	2006	2017	SA001	SC001		YAMAHA	850	XSR 900	2016	2019	SA008	SC008	N
SUZUKI	600	GSF 600 BANDIT	1995	1998	SA008	SC008	N	YAMAHA	900	TDM	2002	2011	SA001	SC001	N
SUZUKI	600	GSX-R600	2000	2005	SA009	SC009	N	YAMAHA	900	TDM ABS	2005	2010	SA001	SC001	N
SUZUKI	600	GSR 600	2006	2012	SA009	SC009	N	YAMAHA	1000	FZ1 FAZER	2006	2014	SA001	SC001	
SUZUKI	650	GLADIUS 650	2009	2015	SA008	SC008	N	YAMAHA	1000	YZF-R1	1998	2019	SA001	SC001	
SUZUKI	650	SV 650	2016	2018	SA008	SC008	N	YAMAHA	1000	FZ1 FAZER ABS	2007	2012	SA001	SC001	N
SUZUKI	650	DR 650	1991	1995	SA008	SC008	N	YAMAHA	1000	FZ1 N	2011	2011	SA001	SC001	N
SUZUKI	650	GSF 650 BANDIT	2005	2012	SA008	SC008	N	YAMAHA	1000	FZ1 NA	2010	2011	SA001	SC001	N
SUZUKI	650	SV 650 / S	2003	2011	SA009	SC009	N	YAMAHA	1000	FZ1	2006	2009	SA001	SC001	N
SUZUKI	750	GSX-R750	2006	2017	SA001	SC001		YAMAHA	1000	MT-10	2016	2019	SA001	SC001	N
SUZUKI	750	GSX-S 750	2017	2018	SA008	SC008	N	YAMAHA	1000	MT-10D	2017	2017	SA001	SC001	N
SUZUKI	750	GSR 750	2010	2016	SA008	SC008	N	YAMAHA	1000	YZF-R1M	2015	2019	SA001	SC001	N
SUZUKI	750	DR 750	1988	1989	SA008	SC008	N	YAMAHA	1300	FJR 1300	2001	2002	SA001	SC001	N
SUZUKI	750	GSX-R750	2000	2005	SA009	SC009	N	YAMAHA	1700	XV WARRIOR	2003	2004	SA001	SC001	N
SUZUKI	800	DR 800	1991	1993	SA008	SC008	N	YAMAHA	1900	XV1900 MIDNIGHT STAR	2006	2006	SA001	SC001	N
SUZUKI	800	VZ800 INTRUDER M800	2012	2016	SA008	SC008	N	YAMAHA	1900	XV1900A MIDNIGHT STAR	2007	2009	SA001	SC001	N
SUZUKI	1000	GSX-R1000	2005	2019	SA001	SC001		YAMAHA	1900	XV1900A MIDNIGHT STAR	2013	2013	SA001	SC001	N
SUZUKI	1000	GSX-S 1000	2015	2018	SA001	SC001	N								

BRAKE/CLUTCH
 MASTER CYLINDERS
 ACCESSORIES
 SPARE PARTS
 CNC-WORKED FLUID
 RESERVOIR
 FULL CLUTCH
 HYDRAULIC-CLUTCH
 TRANFORMATION KIT
 LEVER
 THROTTLE CONTROL
 BRAKE CALIPER
 RACING KIT
 BUTTON PANEL
 LEVER GUARD
 CLIP-ON
 STREET RACING
 REARSET
 FUEL CAPS
 STEERING NUT
 CRASH PADS
 PADDOCK STAND
 MIRROR COVERS
 REAR-VIEW MIRRORS
 FOG LIGHTS KIT
 HANDLEBARS
 ACCESSORIES
 HANDLEBARS

GHIERA PRECARICO FORCELLA

FORK PRELOAD STEERING NUT



Colori / Colours

N 
nero - black

Y 
oro - gold

B 
blu - blue

R 
rosso - red

S 
argento - silver

G 
verde - green

T 
titanio - titanium

- BRAKE/CLUTCH MASTER CYLINDERS
- ACCESSORIES SPARE PARTS
- CNC-WORKED FLUID RESERVOIR
- FULL CLUTCH
- HYDRAULIC-CLUTCH TRANSFORMATION KIT
- LEVER
- THROTTLE CONTROL
- BRAKE CALIPER
- RACING KIT
- BUTTON PANEL
- LEVER GUARD
- CLIP-ON
- STREET RACING REARSET
- FUEL CAPS
- STEERING NUT
- CRASH PADS
- Paddock STAND
- MIRROR COVERS
- REAR-VIEW MIRRORS
- FOG LIGHTS KIT
- HANDLEBARS ACCESSORIES
- HANDLEBARS

Applicazioni / Application list

Marca Brand	CC	Modello Model	Dal From	Al To	Codice Code	Novità New	Marca Brand	CC	Modello Model	Dal From	Al To	Codice Code	Novità New
KAWASAKI	400	ZXR400	1990	2002	AD022		DUCATI	696	MONSTER 696	2008	2013	AD017	
KAWASAKI	600	ZX-6 R	2005	2005	AD022	N	DUCATI	696	MONSTER 696 ABS	2010	2010	AD017	N
KAWASAKI	600	ZX-6 RR	2005	2006	AD022		DUCATI	748	748 SPS	1998	1999	AD022	N
KAWASAKI	600	ZX-6 R	2007	2008	AD019		DUCATI	748	748 S	2000	2002	AD022	N
KAWASAKI	600	ZX-6 R	2003	2004	AD014		DUCATI	748	748 RS	2000	2000	AD022	N
KAWASAKI	636	ZX-6 R	1998	2002	AD017		DUCATI	748	748 R SINGLE SEAT	1998	1998	AD022	N
KAWASAKI	636	ZX-6 R	2005	2006	AD022		DUCATI	748	748 R SINGLE SEAT	2000	2000	AD022	N
KAWASAKI	636	ZX-6 R	2003	2004	AD014	N	DUCATI	748	748 R	1999	1999	AD022	N
KAWASAKI	750	Z750	2007	2012	AD014		DUCATI	748	748 E	2001	2002	AD022	N
KAWASAKI	750	Z750 R	2011	2013	AD019	N	DUCATI	748	748	1995	2001	AD022	
KAWASAKI	800	Z-800	2013	2016	AD014	N	DUCATI	748	749 S	2003	2006	AD022	N
KAWASAKI	900	ZX-9 R	1998	2003	AD017		DUCATI	748	749 DARK	2004	2006	AD022	N
KAWASAKI	1000	Z1000	2003	2006	AD022		DUCATI	748	749	2003	2006	AD022	N
KAWASAKI	1000	Z1000	2007	2013	AD019		DUCATI	796	HYPERMOTARD796	2010	2012	AD017	
KAWASAKI	1000	ZX-10 R	2004	2010	AD014		DUCATI	800	MONSTER S2R 800	2005	2007	AD017	N
KAWASAKI	1200	ZX-12 R	2000	2006	AD017		DUCATI	800	MONSTER S2R 800 DARK	2005	2006	AD017	N
KAWASAKI	1400	ZZR 1400	2006	2018	AD014	N	DUCATI	800	MONSTER 796 (FORCELLA SHOWA)	2011	2011	AD017	N
ANDREANI	--	CARTUCCIA MISANO EVO	--	--	AD017	N	DUCATI	800	MONSTER 796 ABS (FORCELLA SHOWA)	2011	2011	AD017	N
APRILIA	250	RS250	1995	1997	AD022		DUCATI	848	848	2008	2013	AD022	N
APRILIA	1000	RSV1000	2004	2005	AD017		DUCATI	916	916 SPS	1997	1998	AD022	N
APRILIA	1000	RSV1000	1998	2003	AD022		DUCATI	916	916 SP	1994	1996	AD022	N
APRILIA	1000	RSV R -FACTORY - DREAM	2004	2008	AD022	N	DUCATI	916	916 SENNA	1994	1998	AD022	N
APRILIA	1000	RSV R TUONO	2002	2005	AD022	N	DUCATI	916	916	1994	2000	AD022	
APRILIA	1000	RSV1000 R	2000	2003	AD022	N	DUCATI	996	996 SPS II	1999	1999	AD022	N
APRILIA	1000	RSV4 FACTORY - SBK RACING	2009	2010	AD022	N	DUCATI	996	996 SPS	1999	1999	AD022	N
APRILIA	1000	RSV4 FACTORY APRC ABS	2013	2014	AD022	N	DUCATI	996	996 S	2001	2001	AD022	N
APRILIA	1000	RSV4 FACTORY APRC STD - SE	2011	2012	AD022	N	DUCATI	996	996	1999	2001	AD022	
APRILIA	1000	RSV4 RACING FACTORY ABS	2018	2018	AD022	N	DUCATI	998	998 MATRIX SINGLE SEAT	2004	2004	AD022	N
APRILIA	1000	RSV4 RACING FACTORY LE	2015	2017	AD022	N	DUCATI	998	998 MATRIX	2004	2004	AD022	N
APRILIA	1000	RSV4 RR RACER PACK	2015	2015	AD022	N	DUCATI	998	998	2002	2003	AD022	
APRILIA	1000	TUONO FACTORY	2006	2009	AD022	N	DUCATI	998	999	2003	2006	AD022	
APRILIA	1000	TUONO V4 FACTORY	2015	2017	AD022	N	DUCATI	1000	MULTISTRADA 1000	2003	2006	AD022	N
APRILIA	1000	TUONO V4 R STD - APRC	2011	2013	AD017		DUCATI	1000	MONSTER S4 R	2001	2008	AD022	N
APRILIA	1000	TUONO V4 R APRC ABS	2014	2014	AD017		DUCATI	1098	1098	2007	2009	AD022	
APRILIA	1000	RSV4 RR (FORCELLA OHLINS)	2017	2018	AD017		DUCATI	1100	MULTISTRADA 1100	2008	2009	AD022	N
APRILIA	1000	RSV4 RR (FORCELLA SACHS)	2015	2016	AD017	N	DUCATI	1100	HYPERMOTARD 1100	2008	2009	AD022	
APRILIA	1000	RSV4 RR EURO 4 ABS (FORCELLA OHLINS)	2019	2019	AD017	N	DUCATI	1100	HYPERMOTARD 1100 EVO	2008	2009	AD022	
APRILIA	1000	RSV4 RR APRC R	2011	2012	AD017	N	DUCATI	1198	1198	2009	2011	AD022	N
APRILIA	1000	RSV4 RR APRC R ABS	2013	2014	AD017	N	DUCATI	1200	MULTISTRADA 1200	2015	2017	AD014	
APRILIA	1100	TUONO V4 RR	2015	2018	AD017	N	DUCATI	1200	MULTISTRADA 1200 SPORT PACK	2017	2018	AD014	N
APRILIA	1100	TUONO V4 RR EURO 4 ABS	2019	2019	AD017	N	DUCATI	1200	MULTISTRADA 1200 TOURING	2015	2017	AD014	N
BENELLI		TORNADO	2007	2008	AD022		DUCATI	1260	MULTISTRADA 1260	2018	2020	AD014	N
BMW	1000	S1000 RR	2009	2014	AD017		DUCATI	1260	MULTISTRADA 1260 TOURING	2018	2020	AD014	N
BMW	1000	S1000 R	2012	2015	AD017		HONDA	600	CBR600 RR	2005	2006	AD022	
BMW	1000	S1000 RR	2015	2018	AD014	N	HONDA	600	CBR600 RR	2003	2004	AD0	
DUCATI	400	MONSTER 400	2005	2008	AD017	N	HONDA	600	CBR600 F/S	1991	2007	AD0	
DUCATI	400	MONSTER 400 DARK	2005	2005	AD017	N	HONDA	600	CBR600 RR	2007	2012	AD019	
DUCATI	620	MONSTER 620	2006	2006	AD017	N	HONDA	600	HORNET 600	2007	2013	AD019	N
DUCATI	620	MONSTER 620 DARK	2006	2006	AD017	N	HONDA	600	CBR 600 F	2011	2013	AD019	N
DUCATI	620	MULTISTRADA 620	2006	2006	AD017	N	HONDA	900	CBR900 RR	2000	2003	AD022	
DUCATI	620	MULTISTRADA 620 DARK	2006	2006	AD017	N	HONDA	900	CBR900 RR	1992	1999	AD0	
DUCATI	695	MONSTER 695	2007	2008	AD017	N	HONDA	1000	CBR1000 RR	2004	2007	AD022	

BRAKE/CLUTCH
 MASTER CYLINDERS
 ACCESSORIES
 SPARE PARTS
 CNC-WORKED FLUID
 RESERVOIR
 FULL CLUTCH
 HYDRAULIC-CLUTCH
 TRANFORMATION KIT
 LEVER
 THROTTLE CONTROL
 BRAKE CALIPER
 RACING KIT
 BUTTON PANEL
 LEVER GUARD
 CLIP-ON
 STREET RACING
 REARSET
 FUEL CAPS
 STEERING NUT
 CRASH PADS
 PADDOCK STAND
 MIRROR COVERS
 REAR-VIEW MIRRORS
 FOG LIGHTS KIT
 HANDLEBARS
 ACCESSORIES
 HANDLEBARS

Marca Brand	CC	Modello Model	Dal From	Al To	Codice Code	Novità New
HONDA	1000	VTR 1000 SP1 / SP2	2000	2007	AD022	
HONDA	1000	VTR 1000 F	2000	2007	AD0	
HONDA	1000	CB1000 R	2008	2017	AD019	
HONDA	1000	CBR1000 RR	2008	2016	AD019	
MORINI	1200	CORSARO	2007	2008	AD019	
MV AGUSTA	675	F3 675 - ORO	2012	2019	AD022	N
MV AGUSTA	800	F3 800 - AGO - RC	2012	2019	AD022	N
MV AGUSTA	800	BRUTALE 800 - RR - DRAGSTER	2012	2017	AD022	N
MV AGUSTA	900	BRUTALE 989 R - 1078 RR	2008	2008	AD022	N
MV AGUSTA	910	BRUTALE910	2005	2008	AD019	
MV AGUSTA	1000	F4	2012	2013	AD022	
MV AGUSTA	1000	F4 1000 312 R-1078 312 RR	2007	2008	AD022	N
MV AGUSTA	1000	F4 VELTRO	2008	2008	AD019	N
MV AGUSTA	1000	F4 1000 R	2006	2007	AD019	
MV AGUSTA	1078	F4 1000CC	2007	2007	AD019	N
SUZUKI	250	RGV 250 M-T	1991	1996	AD022	N
SUZUKI	600	GSX-R 600	2004	2005	AD022	
SUZUKI	600	GSX-R 600	1997	2003	AD0	
SUZUKI	600	GSX-R 600	2006	2017	AD019	
SUZUKI	750	GSX-R 750	1991	2005	AD022	
SUZUKI	750	GSX-R 750	2006	2017	AD019	
SUZUKI	750	GSX-S 750	2017	2018	AD014	N
SUZUKI	750	GSR 750	2010	2016	AD014	N
SUZUKI	1000	GSX-R 1000	2001	2008	AD014	
SUZUKI	1000	SV 1000	2003	2007	AD014	
SUZUKI	1000	TL 1000	1997	2002	AD017	N
SUZUKI	1000	GSX-S 1000	2015	2018	AD014	N
SUZUKI	1100	GSX-R 1100	1989	1998	AD017	
SUZUKI	1300	GSX-R 1300	1995	1998	AD017	
SUZUKI	1300	B-KING	2007	2012	AD014	N
TRIUMPH	675	DAYTONA 675	2014	2015	AD017	
TRIUMPH	675	DAYTONA 675 R	2006	2016	AD014	
TRIUMPH	675	STREET TRIPLE 675	2007	2016	AD014	
TRIUMPH	955	DAYTONA 955 IE	1999	2002	AD0	
TRIUMPH	955	SPEED TRIPLE 955	2000	2004	AD0	

Marca Brand	CC	Modello Model	Dal From	Al To	Codice Code	Novità New
TRIUMPH	1050	SPEED TRIPLE 1050	2008	2010	AD022	
TRIUMPH	1050	SPEED TRIPLE 1050	2011	2015	AD019	
YAMAHA	300	R300	2015	2016	AD014	N
YAMAHA	320	R320	2017	2018	AD022	N
YAMAHA	600	YZF 600	1996	2002	AD017	
YAMAHA	600	YZF-R6	1999	2004	AD017	
YAMAHA	600	FZ6	2004	2012	AD014	
YAMAHA	600	FZ6 S2	2007	2008	AD014	N
YAMAHA	600	FZ6 NS	2005	2006	AD014	N
YAMAHA	600	FZ6 FAZER	2004	2007	AD014	N
YAMAHA	600	FZ6 FAZER S2	2007	2008	AD014	N
YAMAHA	600	FZ6 FAZER S2 ABS	2008	2008	AD014	N
YAMAHA	600	FZ6 FAZER ABS	2006	2007	AD014	N
YAMAHA	600	YZF-R6	2005	2015	AD014	
YAMAHA	600	YZF-R6	2006	2007	AD017	N
YAMAHA	600	YZF-R6	2008	2016	AD014	N
YAMAHA	600	YZF-R46	2005	2005	AD014	N
YAMAHA	750	YZF 750 R	1993	1998	AD017	
YAMAHA	750	YZF 750 SP	1993	1998	AD017	
YAMAHA	850	MT-09	2013	2015	AD014	
YAMAHA	850	MT-09A ABS	2014	2016	AD014	N
YAMAHA	850	MT-09A TRACER	2015	2019	AD014	N
YAMAHA	850	XSR900	2016	2017	AD014	N
YAMAHA	900	TDM 900	2002	2014	AD017	N
YAMAHA	1000	FZR 1000	1991	1995	AD017	
YAMAHA	1000	THUNDERACE 1000	2000	2005	AD017	
YAMAHA	1000	FAZER 1000	2000	2005	AD017	N
YAMAHA	1000	YZF 1000	1996	2004	AD017	
YAMAHA	1000	YZF-R1	1998	2014	AD014	
YAMAHA	1000	FZ1 N	2006	2012	AD014	N
YAMAHA	1000	FZ1	2006	2015	AD014	N
YAMAHA	1000	FZ1 NA	2010	2010	AD014	N
YAMAHA	1000	FZ1 FAZER	2009	2012	AD014	N
YAMAHA	1000	FZ1 FAZER ABS	2007	2012	AD014	N

BRAKE/CLUTCH
MASTER CYLINDERS

ACCESSORIES
SPARE PARTS

CNC-WORKED FLUID
RESERVOIR

FULL CLUTCH

HYDRAULIC-CLUTCH
TRANFORMATION KIT

LEVER

THROTTLE CONTROL

BRAKE CALIPER

RACING KIT

BUTTON PANEL

LEVER GUARD

CLIP-ON

STREET RACING
REARSET

FUEL CAPS

STEERING NUT

CRASH PADS

PADDOCK STAND

MIRROR COVERS

REAR-VIEW MIRRORS

FOG LIGHTS KIT

HANDLEBARS
ACCESSORIES

HANDLEBARS

TAMPONI PARACARENA

CRASH PADS



Tamponi paracarena con copri vite
Crash pads with screw cover

Ricambi / Spare parts

Codice / Reference	Descrizione / Description
RC050	Copri vite / Screw cover

Colori / Colours

N 
nero - black

Y 
oro - gold

B 
blu - blue

R 
rosso - red

S 
argento - silver

G 
verde - green

T 
titanio - titanium

- BRAKE/CLUTCH MASTER CYLINDERS
- ACCESSORIES SPARE PARTS
- CNC-WORKED FLUID RESERVOIR
- FULL CLUTCH
- HYDRAULIC-CLUTCH TRANSFORMATION KIT
- LEVER
- THROTTLE CONTROL
- BRAKE CALIPER
- RACING KIT
- BUTTON PANEL
- LEVER GUARD
- CLIP-ON
- STREET RACING REARSET
- FUEL CAPS
- STEERING NUT
- CRASH PADS
- Paddock STAND
- MIRROR COVERS
- REAR-VIEW MIRRORS
- FOG LIGHTS KIT
- HANDLEBARS ACCESSORIES
- HANDLEBARS



ACCOSSATO®
Applicazioni / Application list

Marca Brand	CC	Modello Model	Dal From	Al To	Codice Code	Note	Novità New	Marca Brand	CC	Modello Model	Dal From	Al To	Codice Code	Note	Novità New
Aprilia	750	Dorsoduro	2008	2017	TP052			Ducati	800	Scrambler Classic	2015	2018	TP090		N
Aprilia	750	Shiver 750	2007	2016	TP052			Ducati	800	Scrambler Desert Sled 17'	2017	2018	TP090		N
Aprilia	750	Shiver 750 Gt	2008	2016	TP052			Ducati	800	Scrambler Flat Track Pro	2016	2016	TP090		N
Aprilia	900	Dorsoduro	2018	2018	TP052		N	Ducati	800	Scrambler Full Throttle	2015	2018	TP090		N
Aprilia	900	Shiver 900	2017	2018	TP052			Ducati	800	Scrambler Icon	2015	2018	TP090		N
Aprilia	1000	Rsv4	2009	2015	TP058	Forare carena lato SX+DX Pierce the fairing Right/Left Side		Ducati	800	Scrambler Urban Enduro	2015	2016	TP090		N
Aprilia	1000	Rsv4 / Aprc / Rf	2015	2018	TP075	Forare carena lato SX+DX Pierce the fairing Right/Left Side	N	Ducati	821	Hypermotard 821	2013	2016	TP067		
Aprilia	1000	Rsv4 / Factory / Aprc	2009	2014	TP075	Forare carena lato SX+DX Pierce the fairing Right/Left Side	N	Ducati	821	Monster 821	2014	2018	TP080		N
Aprilia	1000	Tuono	2006	2008	TP045	Forare carena lato SX+DX Pierce the fairing Right/Left Side		Ducati	848	848	2007	2008	TP056	Forare carena lato SX+DX Pierce the fairing Right/Left Side	
Aprilia	1100	Tuono V4	2011	2018	TP058		N	Ducati	848	Streetfighter 848	2011	2016	TP052		
Aprilia	1200	Dorsoduro	2008	2017	TP052			Ducati	900	Monster S2R	2001	2007	TP050		
Benelli	300	Bn 302	2014	2018	TP089		N	Ducati	939	Hypermotard 939 Sp	2016	2018	TP067		N
Benelli	500	Leoncino	2018	2019	TP105		N	Ducati	939	Hyperstrada 939	2016	2017	TP067		N
Bmw	750	F750GS	2018	2018	TP107		N	Ducati	950	Hypermotard 950 / SP	2017	2018	TP090		N
Bmw	800	F800 S	2006	2011	TP070		N	Ducati	999	999	2003	2005	TP055	Forare carena lato SX+DX Pierce the fairing Right/Left Side	
Bmw	850	F850GS	2018	2018	TP107		N	Ducati	1000	Monster 1000	2001	2007	TP050		
Bmw	1000	S 1000 RR	2009	2014	TP060			Ducati	1000	Scrambler	2014	2016	TP090		N
Bmw	1000	S 1000 RR	2015	2018	TP066			Ducati	1098	1098	2007	2008	TP056	Forare carena lato SX+DX Pierce the fairing Right/Left Side	
Bmw	1000	S1000 R	2017	2018	TP099		N	Ducati	1100	Hypermotard 1100	2007	2013	TP052		
Bmw	1000	S1000 Xr	2015	2018	TP083		N	Ducati	1100	Hypermotard 1100 Evo	2007	2013	TP052		
Bmw	1170	R Nine-T Scrambler	2016	2018	TP111		N	Ducati	1100	Monster 1100	2008	2014	TP046		
Bmw	800	F800R	2009	2018	TP070		N	Ducati	1100	Scrambler 1100	2018	2019	TP090		N
Cagiva	650	Raptor	2001	2005	TP026		N	Ducati	1100	Scrambler 1100 Special	2018	2019	TP090		N
Cagiva	650	Raptor IE	2006	2006	TP026		N	Ducati	1100	Scrambler 1100 Sport	2018	2019	TP090		N
Cagiva	650	V Raptor	2001	2005	TP026		N	Ducati	1100	Street Fighter	2008	2012	TP044		
Ducati	400	Scrambler Sixty2	2016	2018	TP090		N	Ducati	1100	Streetfighter	2009	2013	TP052		
Ducati	600	Monster 600	2001	2007	TP050			Ducati	1200	Monster 1200 R	2016	2018	TP080		N
Ducati	620	Monster 620	2002	2006	TP050		N	Ducati	1200	Monster 1200/S	2014	2018	TP080		N
Ducati	695	Monster 695	2006	2007	TP050		N	Ducati	1200	Multistrada 1200 S	2010	2014	TP052		
Ducati	696	Monster 696	2008	2014	TP046			Ducati	1200	X Diavel/S	2016	2021	TP092		N
Ducati	796	796	2003	2005	TP055	Forare carena lato SX+DX Pierce the fairing Right/Left Side		Ducati	1200	Diavel	2011	2018	TP046		N
Ducati	796	Hypermotard 796	2007	2012	TP052			Ducati	1200	Diavel strada	2013	2014	TP046		N
Ducati	796	Monster 796	2008	2014	TP046			Honda	125	CB125R	2018	2020	TP103		N
Ducati	797	Monster 797	2017	2018	TP090		N	Honda	125	CB125R Neo Sports Cafe	2018	2018	TP103		N
Ducati	800	Monster 800	2003	2004	TP050		N	Honda	600	CBF600/S	2008	2014	TP013		
Ducati	800	Scrambler Cafe Racer 17'	2017	2018	TP090		N	Honda	600	CBR 600 RR	2004	2016	TP113	Forare carena lato SX+DX Pierce the fairing Right/Left Side	

BRAKE/CLUTCH
MASTER CYLINDERS
 ACCESSORIES
SPARE PARTS
 CNC-WORKED FLUID
RESERVOIR
 FULL CLUTCH
 HYDRAULIC-CLUTCH
TRANFORMATION KIT
 LEVER
 THROTTLE CONTROL
 BRAKE CALIPER
 RACING KIT
 BUTTON PANEL
 LEVER GUARD
 CLIP-ON
 STREET RACING
REARSET
 FUEL CAPS
 STEERING NUT
 CRASH PADS
 PADDOCK STAND
 MIRROR COVERS
 REAR-VIEW MIRRORS
 FOG LIGHTS KIT
 HANDLEBARS
ACCESSORIES
 HANDLEBARS

Marca Brand	CC	Modello Model	Dal From	Al To	Codice Code	Note	Novità New	Marca Brand	CC	Modello Model	Dal From	Al To	Codice Code	Note	Novità New
Honda	600	Hornet 600	1998	2006	TP011			Kawasaki	1000	Zx-10RR	2017	2018	TP042		
Honda	600	Hornet 600	2007	2015	TP013			Ktm	125	125 Duke	2011	2016	TP076		N
Honda	900	CBR900RR	2002	2003	TP020	Forare carena lato SX+DX Pierce the fairing Right/Left Side		Ktm	125	125 Duke	2017	2018	TP078		N
Honda	929	CBR929RR	2001	2002	TP020	Forare carena lato SX Pierce the fairing Left Side		Ktm	200	200 Duke	2012	2015	TP076		N
Honda	1000	CB 1000 R	2008	2018	TP015			Ktm	390	390 Duke	2017	2018	TP078		N
Honda	1000	CB 1000R	2018	2018	TP015		N	Ktm	790	790 Duke	2018	2020	TP081		N
Honda	1000	CBF 1000	2006	2012	TP015			Ktm	1290	1290 Super Duke	2013	2019	TP115		N
Honda	1000	CBR 1000 RR	2008	2016	TP047	Forare carena lato SX+DX Pierce the fairing Right/Left Side		Ktm	1290	1290 Superduke Gt	2016	2018	TP081		N
Honda	1000	CBR 1000RR Fireblade	2017	2018	TP112		N	Ktm	1290	1290 Superduke R	2014	2018	TP081		N
Honda	1000	CBR1000RR Fireblade	2008	2011	TP073	Forare carena lato SX+DX Pierce the fairing Right/Left Side	N	Morini	1200	Corsaro	2007	2010	TP046		
Kawasaki	300	Ninja 300	2013	2018	TP065	Forare carena lato SX Pierce the fairing Left Side		Mv Agusta	675	Brutale 675	2012	2018	TP026		N
Kawasaki	400	Ninja 400	2018	2020	TP101	Forare carena lato SX+DX Pierce the fairing Right/Left Side	N	Mv Agusta	675	F3	2012	2016	TP062	Forare carena lato SX+DX Pierce the fairing Right/Left Side	
Kawasaki	400	Z 400	2019	2020	TP101	Forare carena lato SX+DX Pierce the fairing Right/Left Side	N	Mv Agusta	750	Brutale 750	2001	2012	TP001		
Kawasaki	600	Zx-6RR	2003	2006	TP002	Forare carena lato SX Pierce the fairing Left Side		Mv Agusta	800	Brutale 800	2012	2016	TP026		N
Kawasaki	600	Zx-6RR	2007	2008	TP022	Forare carena lato SX Pierce the fairing Left Side		Mv Agusta	800	Dragster 800	2013	2016	TP026		N
Kawasaki	636	Zx-6R	2003	2006	TP002	Forare carena lato SX Pierce the fairing Left Side		Mv Agusta	800	Dragster 800	2017	2018	TP026		N
Kawasaki	636	Zx-6R	2007	2008	TP022	Forare carena lato SX Pierce the fairing Left Side		Mv Agusta	800	Rivale 800	2013	2018	TP026		N
Kawasaki	636	Zx-6R	2009	2012	TP023	Forare carena lato SX+DX Pierce the fairing Right/Left Side		Mv Agusta	800	Stradale 800	2015	2018	TP026		N
Kawasaki	636	Zx-6R	2013	2017	TP077		N	Mv Agusta	800	Turismo Veloce 800	2014	2016	TP026		N
Kawasaki	650	Ninja 650	2017	2018	TP114		N	Mv Agusta	800	Turismo Veloce 800 Lusso	2014	2016	TP026		N
Kawasaki	650	Versys 650	2015	2018	TP084		N	Mv Agusta	910	Brutale 910	2001	2012	TP001		
Kawasaki	650	Z650	2017	2020	TP096		N	Mv Agusta	1000	Brutale 1000	2001	2012	TP001		
Kawasaki	750	Z750	2004	2006	TP007			Mv Agusta	1090	Brutale 1090	2001	2012	TP001		
Kawasaki	750	Z750	2007	2013	TP021			Suzuki	600	GSR 600	2006	2012	TP016		
Kawasaki	750	Z750R	2011	2012	TP021			Suzuki	600	GSX-R600	2006	2017	TP006	Forare carena lato SX Pierce the fairing Left Side	
Kawasaki	750	Z750S	2005	2006	TP007			Suzuki	600	GSX-R600	2004	2005	TP020		
Kawasaki	900	Z900Rs	2018	2020	TP101		N	Suzuki	650	DL650 V-Strom	2004	2018	TP046		N
Kawasaki	900	Z900Rs Café	2019	2020	TP101		N	Suzuki	650	DL650t V-Strom	2015	2018	TP046		N
Kawasaki	1000	Z1000	2003	2006	TP007			Suzuki	650	Gladius	2009	2015	TP054		N
Kawasaki	1000	Z1000	2007	2013	TP021			Suzuki	650	GSF650 Bandit	2007	2011	TP071		N
Kawasaki	1000	Z1000	2014	2018	TP041			Suzuki	650	GSF650S Bandit	2007	2014	TP071		N
Kawasaki	1000	Z1000R	2017	2018	TP041			Suzuki	650	Sv 650	2016	2018	TP054		N
Kawasaki	1000	Z1000Sx	2017	2018	TP098		N	Suzuki	650	Sv 650 X	2018	2018	TP054		N
Kawasaki	1000	Zx-10R	2011	2018	TP042			Suzuki	750	Gsr 750	2012	2016	TP024		
Kawasaki	1000	Zx-10R	2008	2010	TP048	Forare carena lato SX+DX Pierce the fairing Right/Left Side		Suzuki	750	Gsx-R750	2006	2017	TP006	Forare carena lato SX Pierce the fairing Left Side	
Kawasaki	1000	Zx-10R Se	2018	2018	TP042			Suzuki	750	Gsx-R750	2004	2005	TP020		

BRAKE/CLUTCH
 MASTER CYLINDERS
 ACCESSORIES
 SPARE PARTS
 CNC-WORKED FLUID
 RESERVOIR
 FULL CLUTCH
 HYDRAULIC-CLUTCH
 TRANFORMATION KIT
 LEVER
 THROTTLE CONTROL
 BRAKE CALIPER
 RACING KIT
 BUTTON PANEL
 LEVER GUARD
 CLIP-ON
 STREET RACING
 REARSET
 FUEL CAPS
 STEERING NUT
 CRASH PADS
 PADDOCK STAND
 MIRROR COVERS
 REAR-VIEW MIRRORS
 FOG LIGHTS KIT
 HANDLEBARS
 ACCESSORIES
 HANDLEBARS

Marca Brand	CC	Modello Model	Dal From	Al To	Codice Code	Note	Novità New	Marca Brand	CC	Modello Model	Dal From	Al To	Codice Code	Note	Novità New
Suzuki	750	Gsx-S750	2017	2018	TP024			Yamaha	530	Tmax 530	2006	2012	TP012		
Suzuki	1000	DL1000 V-Strom	2014	2018	TP079		N	Yamaha	600	Fz6	2004	2012	TP005		
Suzuki	1000	DL1000Xt V-Strom	2017	2018	TP079		N	Yamaha	600	Fz6 Fazer	2004	2012	TP005		
Suzuki	1000	Gsx-R1000	2017	2020	TP012	Forare carena lato SX+DX Pierce the fairing Right/Left Side	N	Yamaha	600	Fz6 Fazer S2	2007	2010	TP005		
Suzuki	1000	Gsx-R1000	2005	2006	TP017	Forare carena lato SX+DX Pierce the fairing Right/Left Side		Yamaha	600	Xj6	2009	2016	TP057		
Suzuki	1000	Gsx-R1000	2007	2008	TP020			Yamaha	600	Xj6 Diversion	2009	2016	TP057		
Suzuki	1000	Gsx-R1000	2009	2015	TP061	Forare carena lato SX+DX Pierce the fairing Right/Left Side		Yamaha	600	Yzf-R6	2006	2016	TP004	Forare carena lato SX Pierce the fairing Left Side	
Suzuki	1000	Gsx-S1000	2015	2019	TP086		N	Yamaha	600	Yzf-R6	2003	2005	TP008	Forare carena lato DX Pierce the fairing Right Side	
Suzuki	1000	Gsx-S1000F	2015	2020	TP087		N	Yamaha	600	Yzf-R6	2017	2020	TP109	Forare carena lato SX+DX Pierce the fairing Right/Left Side	N
Suzuki	1000	Katana	2019	2019	TP086		N	Yamaha	689	Mt-07	2014	2020	TP064		
Suzuki	1250	GSF 1250 Bandit	2007	2013	TP071		N	Yamaha	700	Mt-07 Tracer	2016	2018	TP064		
Suzuki	1250	GSF 1250S Bandit	2007	2013	TP071		N	Yamaha	800	Fazer8	2013	2016	TP012		
Suzuki	1300	Gsx 1300R Hayabusa	2008	2017	TP072	Forare carena lato SX+DX Pierce the fairing Right/Left Side	N	Yamaha	800	Fz8	2010	2016	TP012		
Triumph	675	Daytona	2006	2013	TP009	Forare carena lato SX+DX Pierce the fairing Right/Left Side		Yamaha	800	Fz8 Fazer	2010	2012	TP012		
Triumph	675	Street Triple	2007	2015	TP053			Yamaha	847	Mt-09	2013	2016	TP063		
Triumph	900	Bonneville T100	2016	2018	TP093		N	Yamaha	847	Mt-09	2017	2020	TP097		N
Triumph	900	Street Cup	2017	2018	TP093		N	Yamaha	847	Mt-09 Sp	2018	2020	TP097		N
Triumph	900	Street Twin	2016	2018	TP093		N	Yamaha	847	Tracer 900 GT	2018	2020	TP097		N
Triumph	1050	Speed Triple	2005	2010	TP010			Yamaha	847	XSR 900	2016	2020	TP097		N
Triumph	1050	Speed Triple	2011	2018	TP043			Yamaha	900	Mt-09 Tracer	2015	2018	TP063		
Triumph	1050	Speed Triple R	2012	2018	TP043			Yamaha	900	Mt-09 Tracer Gt	2018	2019	TP063		
Triumph	1050	Street Triple R	2009	2012	TP053			Yamaha	900	Tracer 900	2015	2017	TP063		
Triumph	1200	Bonneville	2007	2015	TP049			Yamaha	1000	Fz1	2006	2015	TP012		
Triumph	1200	Bonneville Bobber	2017	2018	TP093		N	Yamaha	1000	Fz1 Fazer	2006	2015	TP012		
Triumph	1200	Bonneville T120	2016	2018	TP093		N	Yamaha	1000	Mt-10	2016	2020	TP025		
Triumph	1200	ThruXton 1200/R	2016	2018	TP093		N	Yamaha	1000	Mt-10 Sp	2017	2020	TP025		
Yamaha	125	Mt-125	2015	2018	TP088		N	Yamaha	1000	Yzf-R1	1998	2003	TP014		
Yamaha	250	Mt-25	2015	2018	TP094		N	Yamaha	1000	Yzf-R1	2004	2006	TP018		
Yamaha	250	YZF-R25	2014	2018	TP077		N	Yamaha	1000	Yzf-R1	2007	2008	TP019	Forare carena lato SX+DX Pierce the fairing Right/Left Side	
Yamaha	300	Mt-03	2015	2020	TP094		N	Yamaha	1000	Yzf-R1	2015	2020	TP025		
Yamaha	300	Mt-03	2006	2014	TP117		N	Yamaha	1000	Yzf-R1	2009	2014	TP051	Forare carena lato SX+DX Pierce the fairing Right/Left Side	
Yamaha	320	YZF-R3	2015	2018	TP077		N	Yamaha	1000	Yzf-R1 Sp	2006	2016	TP018		
								Yamaha	1000	Yzf-R1M	2017	2020	TP025		
								Yamaha	900	Tdm 900	2002	2014	TP069		N

Nota: questi tamponi paracarena possono essere montati su altre moto
 Note: these crash pads can be fitted on other motorbikes

- BRAKE/CLUTCH MASTER CYLINDERS
- ACCESSORIES SPARE PARTS
- CNC-WORKED FLUID RESERVOIR
- FULL CLUTCH
- HYDRAULIC-CLUTCH TRANFORMATION KIT
- LEVER
- THROTTLE CONTROL
- BRAKE CALIPER
- RACING KIT
- BUTTON PANEL
- LEVER GUARD
- CLIP-ON
- STREET RACING REARSET
- FUEL CAPS
- STEERING NUT
- CRASH PADS
- PADDOCK STAND
- MIRROR COVERS
- REAR-VIEW MIRRORS
- FOG LIGHTS KIT
- HANDLEBARS ACCESSORIES
- HANDLEBARS

PROTEZIONE CORONA

SPROCKET DEFENDER



Codice Reference	Descrizione Description	Caratteristiche tecniche Technical details
SP001	Protezione corona Sprocket defender	Materiale / Raw material: Alluminio / Aluminium Spessore / Thickness: 3 mm

Applicazioni / Application list

Marca Brand	CC	Modello Model	Anno dal From	Anno al To	Codice Code	Novità New
KAWASAKI	600	ZX-6 R	2003	2014	SP001	
KAWASAKI	636	ZX-636 R	2003	2014	SP001	
KAWASAKI	1000	ZX-10 R	2004	2014	SP001	
SUZUKI	600	GSX-R	2004	2014	SP001	
SUZUKI	750	GSX-R	2004	2014	SP001	
SUZUKI	1000	GSX-R	2003	2008	SP001	
SUZUKI	1000	GSX-R	2009	2014	SP001	
SUZUKI	1000	GSX-R	2018	2019	SP001	N
SUZUKI	1000	GSX-S	2016	2019	SP001	N

Spiegazione Explanation

Il montaggio avviene direttamente sul nottolino del forcellone, senza effettuare modifiche.
Direct assembly on swing arm so modifications are required.

Colori / Colours

N 	O 	Y 	B 	R 	S 	G 
nero - black	arancione orange	oro - gold	blu - blue	rosso - red	argento - silver	verde - green

BRAKE/CLUTCH
MASTER CYLINDERS
 ACCESSORIES
SPARE PARTS
 CNC-WORKED FLUID
RESERVOIR
 FULL CLUTCH
 HYDRAULIC-CLUTCH
TRANFORMATION KIT
 LEVER
 THROTTLE CONTROL
 BRAKE CALIPER
 RACING KIT
 BUTTON PANEL
 LEVER GUARD
 CLIP-ON
 STREET RACING
REARSET
 FUEL CAPS
 STEERING NUT
 CRASH PADS
 PADDOCK STAND
 MIRROR COVERS
 REAR-VIEW MIRRORS
 FOG LIGHTS KIT
 HANDLEBARS
ACCESSORIES
 HANDLEBARS

PROTEZIONE FORCELLA

FORK PROTECTION



- BRAKE/CLUTCH MASTER CYLINDERS
- ACCESSORIES SPARE PARTS
- CNC-WORKED FLUID RESERVOIR
- FULL CLUTCH
- HYDRAULIC-CLUTCH TRANSFORMATION KIT
- LEVER
- THROTTLE CONTROL
- BRAKE CALIPER
- RACING KIT
- BUTTON PANEL
- LEVER GUARD
- CLIP-ON
- STREET RACING REARSET
- FUEL CAPS
- STEERING NUT
- CRASH PADS
- Paddock STAND
- MIRROR COVERS
- REAR-VIEW MIRRORS
- FOG LIGHTS KIT
- HANDLEBARS ACCESSORIES
- HANDLEBARS

Marca Brand	CC	Modello Model	Dal From	Al To	Codice prot. forcella ant. Front fork protection code	Codice prot. forcella post. Rear fork protection code	Novità New	Marca Brand	CC	Modello Model	Dal From	Al To	Codice prot. forcella ant. Front fork protection code	Codice prot. forcella post. Rear fork protection code	Novità New
Aprilia	750	Dorsoduro 750	2009	2015		PP011		Ducati	821	Hypermotard 821	2013	2016	PF042		
Aprilia	750	Dorsoduro 750	2008	2016	PF031			Ducati	821	Hyperstrada	2013	2015	PF05		N
Aprilia	750	Shiver 750	2007	2016	PF031	PP011	N	Ducati	821	Monster 821	2014	2021	PF049		N
Aprilia	750	Shiver 750 Gt	2007	2016	PF031	PP011	N	Ducati	821	Monster 821	2018	2019		PP084	N
Aprilia	900	Dorsoduro 900	2017	2018	PF031		N	Ducati	821	Monster 821 Dark	2020	2021	PF049		N
Aprilia	900	Shiver 900	2017	2018	PF031		N	Ducati	848	848	2007	2012	PF05		
Aprilia	1000	Rsv4	2009	2015		PP001		Ducati	848	848 Evo	2011	2013	PF05		N
Aprilia	1000	Rsv4	2017	2019		PP068	N	Ducati	848	Streetfighter	2009	2015		PP069	N
Aprilia	1000	Rsv4 R / Factory / Aprc	2009	2018	PF031			Ducati	899	899 Panigale	2014	2015	PF033		N
Aprilia	1100	Tuono V4	2011	2018	PF031		N	Ducati	939	Hypermotard 939 Sp	2016	2018	PF05		N
Aprilia	1200	Caponord 1200	2013	2016	PF031		N	Ducati	939	Supersport 939 S	2017	2018	PF049		N
Aprilia	1200	Dorsoduro 1200	2009	2015	PF019	PP011		Ducati	959	959 Panigale	2017	2019	PF033	PP079	N
Benelli	500	Trk 502	2016	2019	PF033		N	Ducati	959	959 Panigale Corse	2018	2019	PF033	PP079	N
Bmw	750	F750 Gs	2018	2018	PF066		N	Ducati	999	999	2002	2006	PF015	PP005	
Bmw	800	F800 R	2015	2018	PF058		N	Ducati	1098	1098	2007	2012	PF05		
Bmw	850	F850 Gs	2018	2018	PF066		N	Ducati	1100	Hypermotard 1100	2008	2013	PF016		
Bmw	900	F900 R	2018	2019	PF057		N	Ducati	1100	Hypermotard 1100 Evo	2008	2013	PF016		
Bmw	900	F900 Xr	2018	2019	PF057		N	Ducati	1100	Hypermotard 1100 S	2007	2009	PF016		N
Bmw	1000	HP4	2011	2014		PP001	N	Ducati	1100	Monster 1100 Evo	2011	2013	PF012		N
Bmw	1000	S1000 R	2014	2018		PP001	N	Ducati	1100	Monster 1100 S	2009	2013	PF012		N
Bmw	1000	S1000 R	2012	2018	PF047			Ducati	1100	Panigale V2	2020	2021	PF050		N
Bmw	1000	S1000 Rr	2009	2014	PF025	PP010		Ducati	1100	Panigale V4	2018	2020	PF050		N
Bmw	1000	S1000 Rr	2015	2018	PF043	PP017		Ducati	1100	Panigale V4	2018	2019		PP070	N
Bmw	1000	S1000 Xr	2015	2018		PP001	N	Ducati	1100	Panigale V4 R	2019	2020	PF050		N
Bmw	1000	S1000 Xr	2015	2019	PF057		N	Ducati	1100	Panigale V4 S	2018	2019	PF050	PP070	N
Bmw	1170	R Nine T Pure	2017	2018	PF059	PP082	N	Ducati	1100	Panigale V4 Speciale	2018	2019	PF050	PP070	N
Bmw	1170	R Nine T Racer	2017	2018	PF059	PP082	N	Ducati	1100	Scrambler 1100	2018	2018	PF067	PP018	N
Bmw	1170	R Nine T Scrambler (K23)	2016	2016	PF048		N	Ducati	1100	Scrambler 1100 Special	2018	2018	PF067	PP018	N
Bmw	1200	R 1200 Gs Exclusive	2017	2018	PF048		N	Ducati	1100	Scrambler 1100 Sport	2018	2018	PF067	PP018	N
Bmw	1200	R 1200 Gs Rallye	2017	2018	PF048		N	Ducati	1100	Streetfighter V4	2020	2020	PF050		N
Bmw	1200	R Gs Adventure (K255)	2006	2013	PF048		N	Ducati	1199	1199 Panigale	2012	2015	PF033		
Bmw	1200	R Gs Adventure (K51)	2014	2018	PF048		N	Ducati	1199	1199 Superleggera	2014	2014	PF033		N
Bmw	1200	R Nine T (K21)	2013	2016	PF048		N	Ducati	1199	Panigale S	2012	2013	PF050		N
Bmw	1200	R Nine T Urban G/S	2017	2018	PF059	PP082	N	Ducati	1199	Panigale S Abs	2012	2014	PF050		N
Bmw	1200	R1200 Gs	2017	2018	PF048	PP082	N	Ducati	1200	Diavel	2012	2015	PF030		
Bmw	1200	R1200 Gs	2013	2016		PP082	N	Ducati	1200	Monster 1200	2019	2021	PF049		N
Bmw	1200	R1200 Gs Adventure	2014	2018		PP082	N	Ducati	1200	Monster 1200 / R	2014	2017		PP069	N
Bmw	1200	R1200 R	2015	2018	PF057	PP082	N	Ducati	1200	Monster 1200 / R	2014	2018	PF05		N
Bmw	1200	R1200 Rs	2015	2018	PF057	PP082	N	Ducati	1200	Monster 1200 S	2014	2016	PF05	PP069	N
Bmw	1200	R1200Gs	2009	2012	PF048		N	Ducati	1200	Monster 1200 S	2017	2018	PF05	PP070	N
Bmw	1200	R1200Gs Rallye	2017	2018		PP082	N	Ducati	1200	Multistrada 1200 Enduro Pro	2016	2018	PF05	PP069	N
Bmw	1200	R1250 Gs	2018	2019	PF048	PP082	N	Ducati	1200	Multistrada 1200 Pikes Peak	2016	2017	PF05	PP069	N
Bmw	1200	R1250 R	2015	2019	PF057		N	Ducati	1200	Multistrada 1200 S	2015	2017		PP069	N
Bmw	1200	R1250 Rs	2015	2019	PF057		N	Ducati	1200	Multistrada 1260 Pikes Peak	2018	2018	PF05	PP070	N
Buell	1200	Xb12	2008	2010	PF023			Ducati	1200	Multistrada 1260 S / S D-Air	2018	2018	PF05		N
Ducati	696	Monster 696	2008	2014	PF012			Ducati	1200	X Diavel/S	2016	2018	PF060	PP069	N
Ducati	749	749	2002	2007	PF015	PP005		Ducati	1260	Multistrada 950	2017	2018	PF05		N
Ducati	796	Hypermotard 796	2008	2013	PF016			Ducati	1260	Multistrada 1200 S	2010	2017	PF05		
Ducati	796	Monster 796	2010	2014	PF012		N	Ducati	1299	1299 S Abs	2015	2017	PF050		N
Ducati	797	Monster 797	2017	2020	PF049		N	Ducati	1299	Panigale	2015	2017	PF050		N
Ducati	797	Monster 797 Plus	2017	2019	PF049		N	Honda	600	Cb 600 F Hornet	2007	2015	PF013		N
Ducati	800	Scrambler Cafe Racer	2017	2018	PF044	PP018	N	Honda	600	Cbr 600 Rr	2003	2016	PF013	PP006	
Ducati	800	Scrambler Classic	2015	2018	PF044	PP018		Honda	750	Xadv	2017	2018		PP072	N
Ducati	800	Scrambler Desert Sled	2017	2018	PF067	PP018	N	Honda	1000	Cb 1000 R	2008	2017	PF013		
Ducati	800	Scrambler Flat Track Pro	2016	2016	PF044	PP018	N	Honda	1000	Cbr 1000 Rr	2017	2018	PF051	PP071	N
Ducati	800	Scrambler Full Throttle	2015	2018	PF044	PP018	N	Honda	1000	Cbr 1000 Rr	2004	2016	PF011		
Ducati	800	Scrambler Icon	2015	2018	PF044	PP018	N	Honda	1000	Cbr 1000 Rr	2004	2007		PP012	N
Ducati	800	Scrambler Sixty2	2016	2018	PF044	PP018	N	Honda	1000	Cbr 1000 Rr R	2020	2020	PF051		N
Ducati	800	Scrambler Urban Enduro	2015	2016	PF044	PP018	N	Honda	1000	Cbr 1000 Rr Sp	2020	2020	PF051		N

- BRAKE/CLUTCH MASTER CYLINDERS
- ACCESSORIES SPARE PARTS
- CNC-WORKED FLUID RESERVOIR
- FULL CLUTCH
- HYDRAULIC-CLUTCH TRANFORMATION KIT
- LEVER
- THROTTLE CONTROL
- BRAKE CALIPER
- RACING KIT
- BUTTON PANEL
- LEVER GUARD
- CLIP-ON
- STREET RACING REARSET
- FUEL CAPS
- STEERING NUT
- CRASH PADS
- PADDOCK STAND
- MIRROR COVERS
- REAR-VIEW MIRRORS
- FOG LIGHTS KIT
- HANDLEBARS ACCESSORIES
- HANDLEBARS

Marca Brand	CC	Modello Model	Dal From	Al To	Codice prot. forcella ant. Front fork protection code	Codice prot. forcella post. Rear fork protection code	Novità New	Marca Brand	CC	Modello Model	Dal From	Al To	Codice prot. forcella ant. Front fork protection code	Codice prot. forcella post. Rear fork protection code	Novità New
Honda	1000	Cbr1000Rr Fireblade	2012	2013	PF051		N	Suzuki	1000	Gsx-S 1000	2015	2021	PF054		N
Honda	1000	Cbr1000Rr Fireblade	2008	2011	PF051		N	Suzuki	1000	Gsx-S 1000 F	2015	2018	PF054		N
Honda	1000	Cbr1000Rr Fireblade Sp / Sp2	2017	2018	PF051		N	Suzuki	1000	Gsx-S1000F	2015	2020		PP077	N
Honda	1000	Cbr1000Rr Sp	2014	2016	PF051		N	Triumph	675	Daytona 675	2006	2015	PF03		N
Kawasaki	600	Zx-6 R	2003	2016	PF08	PP004		Triumph	675	Daytona 675	2006	2012		PP003	N
Kawasaki	650	Ninja 650	2017	2020	PF052		N	Triumph	675	Daytona 675 R	2013	2016	PF03	PP003	N
Kawasaki	650	Z650	2017	2020	PF052		N	Triumph	765	Street Triple	2007	2018	PF03	PP003	N
Kawasaki	750	Z750	2007	2012	PF02			Triumph	765	Street Triple R	2009	2018	PF03	PP003	N
Kawasaki	900	Z900	2017	2018	PF02		N	Triumph	765	Street Triple Rs	2017	2019	PF03	PP003	N
Kawasaki	900	Z900 Rs	2018	2018	PF02		N	Triumph	765	Street Triple S	2017	2018		PP003	N
Kawasaki	1000	Z1000	2007	2010	PF02			Triumph	1050	Speed Triple	2011	2015	PF028		
Kawasaki	1000	Z1000	2011	2017	PF029			Triumph	1050	Speed Triple	2005	2010	PF06		
Kawasaki	1000	Z1000 Sx	2011	2017	PF02		N	Triumph	1050	Speed Triple R	2012	2015	PF03		N
Kawasaki	1000	Zx-10 R	2006	2007	PF04		N	Yamaha	300	Mt-03	2008	2010	PF024		
Kawasaki	1000	Zx-10 R	2011	2015		PP004	N	Yamaha	300	R300 / R320	2015	2016		PP078	N
Kawasaki	1000	Zx-10 R	2008	2017	PF08			Yamaha	320	Mt-03	2016	2018	PF064		N
Kawasaki	1000	Zx-10R	2016	2020		PP073	N	Yamaha	320	Yzf-R3	2015	2018	PF064		N
Kawasaki	1000	Zx-10R	2018	2020	PF061		N	Yamaha	530	T-Max 530	2012	2016	PF032		
Kawasaki	1000	Zx-10Rr	2017	2018	PF061	PP073	N	Yamaha	530	T-Max 530 / Dx / Sx	2017	2020	PF063		N
Ktm	1190	Rc8	2008	2012	PF035	PP013		Yamaha	530	T-Max 530 Abs	2017	2020	PF063		N
Ktm	1290	1290 Superduke Gt	2016	2018	PF062		N	Yamaha	560	T-max 560	2015	2020	PF063		N
Ktm	1290	1290 Superduke R	2014	2018	PF062		N	Yamaha	600	Fz6	2004	2014	PF09		
Ktm	1290	Super Duke	2017	2018		PP074	N	Yamaha	600	Fz6 Fazer	2004	2008	PF09		N
Morini	1200	Corsaro	2008	2010	PF010			Yamaha	600	Fz6 Fazer S2	2007	2010	PF09		N
Mv Agusta	675	B3 675	2012	2016		PP075	N	Yamaha	600	Yzf-R6	2017	2020	PF046	PP009	N
Mv Agusta	675	Brutale B3 675	2012	2016	PF034			Yamaha	600	Yzf-R6	2007	2016	PF013		
Mv Agusta	675	F3 675	2012	2016	PF034	PP075	N	Yamaha	600	Yzf-R6	1999	2002	PF021		
Mv Agusta	800	B3 800	2012	2016		PP075	N	Yamaha	600	Yzf-R6	2001	2015		PP001	N
Mv Agusta	800	Brutale	2010	2016		PP075	N	Yamaha	700	Mt-07	2014	2018	PF041		N
Mv Agusta	800	Brutale 800 Rr / Pirelli / America / Rc / Lh44	2013	2019	PF034		N	Yamaha	700	Xsr 700	2016	2018	PF041		N
Mv Agusta	800	Brutale B3 800	2012	2016	PF034			Yamaha	850	Mt-09	2014	2020	PF055		N
Mv Agusta	800	Brutale Dragster 800 Rr / Rc / Pirelli / America	2014	2018	PF034		N	Yamaha	850	Mt-09	2017	2020		PP080	N
Mv Agusta	800	F3 800	2012	2016	PF034	PP075	N	Yamaha	850	Mt-09 Sp	2018	2018		PP080	N
Mv Agusta	800	Rivale	2013	2016	PF045	PP075	N	Yamaha	850	Mt09 Tracer	2015	2020	PF055		N
Mv Agusta	800	Rvs #1	2018	2018	PF034		N	Yamaha	850	Mt09 Tracer Gt	2017	2018		PP080	N
Mv Agusta	800	Stradale	2015	2015	PF034		N	Yamaha	850	Xsr 900	2016	2020	PF055	PP080	N
Mv Agusta	800	Turismo Veloce 800	2014	2018	PF034		N	Yamaha	850	XSR 900 80 Black	2020	2020		PP080	N
Mv Agusta	800	Turismo Veloce 800 Lusso	2014	2018	PF034		N	Yamaha	850	Xsr 900 Black	2020	2020	PF055		N
Mv Agusta	1000	F4	2012	2016	PF034	PP075	N	Yamaha	900	Mt-09	2013	2016	PF040		N
Suzuki	600	Gsr 600	2006	2011	PF014	PP002		Yamaha	900	Mt-09 Sp	2018	2018	PF040		N
Suzuki	600	Gsx-R 600	2006	2017	PF01	PP001		Yamaha	900	Mt-09 Tracer	2015	2018	PF040		N
Suzuki	600	Gsx-R 600	2011	2017	PF054		N	Yamaha	900	Mt-09 Tracer Gt	2017	2018	PF055		N
Suzuki	600	Gsx-R 600	2001	2004	PF018			Yamaha	900	Mt-09 Tracer Gt	2018	2018	PF040		N
Suzuki	600	Gsx-R 600	1999	1999	PF022			Yamaha	900	Xsr 900	2016	2018	PF040		N
Suzuki	600	Gsx-R 600 Srad	1998	1998		PP008		Yamaha	1000	Fz1	2006	2014	PF07	PP001	
Suzuki	750	Gsr 750	2012	2016	PF014	PP014		Yamaha	1000	Mt-10	2016	2018	PF046	PP019	N
Suzuki	750	Gsx-R 750	2006	2017	PF01	PP001		Yamaha	1000	Mt-10 Sp	2017	2018	PF046	PP019	N
Suzuki	750	Gsx-R 750	2011	2016	PF054		N	Yamaha	1000	Yzf-R1	2004	2014	PF013	PP001	
Suzuki	750	Gsx-R 750	2001	2004	PF018			Yamaha	1000	Yzf-R1	1998	2003	PF021	PP009	
Suzuki	750	Gsx-S 750	2017	2021	PF054		N	Yamaha	1000	Yzf-R1	2015	2018	PF046	PP019	N
Suzuki	1000	Gsx-R 1000	2017	2020	PF053	PP076	N	Yamaha	1000	Yzf-R1 M	2015	2018	PF046	PP019	N
Suzuki	1000	Gsx-R 1000	2005	2016	PF01			Yamaha	1100	Xt 1200 Z Supertenera	2014	2018	PF065		N
Suzuki	1000	Gsx-R 1000	2009	2016		PP001	N								
Suzuki	1000	Gsx-R 1000	2005	2006		PP007	N								
Suzuki	1000	Gsx-S 1000	2015	2020		PP077	N								

Nota: queste protezioni forcella possono essere montati su altre moto
 Note: these fork protection can be fitted on other motorbikes

- BRAKE/CLUTCH MASTER CYLINDERS
- ACCESSORIES SPARE PARTS
- CNC-WORKED FLUID RESERVOIR
- FULL CLUTCH
- HYDRAULIC-CLUTCH TRANFORMATION KIT
- LEVER
- THROTTLE CONTROL
- BRAKE CALIPER
- RACING KIT
- BUTTON PANEL
- LEVER GUARD
- CLIP-ON
- STREET RACING REARSET
- FUEL CAPS
- STEERING NUT
- CRASH PADS
- PADDOCK STAND
- MIRROR COVERS
- REAR-VIEW MIRRORS
- FOG LIGHTS KIT
- HANDLEBARS ACCESSORIES
- HANDLEBARS

CAVALLETTO ANTERIORE SMONTABILE

FRONT DISASSEMBLED STAND



- BRAKE/CLUTCH MASTER CYLINDERS
- ACCESSORIES SPARE PARTS
- CNC-WORKED FLUID RESERVOIR
- FULL CLUTCH
- HYDRAULIC-CLUTCH TRANSFORMATION KIT
- LEVER
- THROTTLE CONTROL
- BRAKE CALIPER
- RACING KIT
- BUTTON PANEL
- LEVER GUARD
- CLIP-ON
- STREET RACING REARSET
- FUEL CAPS
- STEERING NUT
- CRASH PADS
- Paddock STAND
- MIRROR COVERS
- REAR-VIEW MIRRORS
- FOG LIGHTS KIT
- HANDLEBARS ACCESSORIES
- HANDLEBARS

Codice Reference	Descrizione Description
AV003	Cavalletto anteriore smontabile Front disassembled stand

Colori / Colours

N 
nero - black

O 
arancione
orange

Y 
oro - gold

B 
blu - blue

R 
rosso - red

S 
argento - silver

G 
verde - green

Spiegazione Explanation

Il cavalletto anteriore smontabile Accossato consente di ridurre l'ingombro durante il trasporto. Realizzato in alluminio, è disponibile in diverse colorazioni. Il cavalletto è venduto con il supporto a cono, che lo rende adatto a tutte le moto che richiedono il sollevamento da sotto gli steli della moto.

Accossato front decomposable stand allows to reduce volume at minimum to ease carriage at best. Made in aluminium, front part is available in several colours. Stand is supplied with its "cone-shaped" supports. Provided with supports, stand width becomes adjustable it could be used on any motorcycles requiring lifting from underneath the fork stem.

BRAKE/CLUTCH
MASTER CYLINDERS

ACCESSORIES
SPARE PARTS

CNC-WORKED FLUID
RESERVOIR

FULL CLUTCH

HYDRAULIC-CLUTCH
TRANFORMATION KIT

LEVER

THROTTLE CONTROL

BRAKE CALIPER

RACING KIT

BUTTON PANEL

LEVER GUARD

CLIP-ON

STREET RACING
REARSET

FUEL CAPS

STEERING NUT

CRASH PADS

Paddock STAND

MIRROR COVERS

REAR-VIEW MIRRORS

FOG LIGHTS KIT

HANDLEBARS
ACCESSORIES

HANDLEBARS

CAVALLETTO POSTERIORE SMONTABILE

REAR DISASSEMBLED STAND



BRAKE/CLUTCH
MASTER CYLINDERS

ACCESSORIES
SPARE PARTS

CNC-WORKED FLUID
RESERVOIR

FULL CLUTCH

HYDRAULIC-CLUTCH
TRANFORMATION KIT

LEVER

THROTTLE CONTROL

BRAKE CALIPER

RACING KIT

BUTTON PANEL

LEVER GUARD

CLIP-ON

STREET RACING
REARSET

FUEL CAPS

STEERING NUT

CRASH PADS

PADDOCK STAND

MIRROR COVERS

REAR-VIEW MIRRORS

FOG LIGHTS KIT

HANDLEBARS
ACCESSORIES

HANDLEBARS

Codice Reference	Descrizione Description
AV001	Cavalletto posteriore smontabile con staffa a "L" <i>Rear disassembled stand provided with "L"-shaped bracket</i>
AV002	Cavalletto posteriore smontabile con staffa a "V" <i>Rear disassembled stand provided with "V"-shaped bracket</i>

Colori / Colours

N 	O 	Y 	B 	R 	S 	G 
nero - black	arancione orange	oro - gold	blu - blue	rosso - red	argento - silver	verde - green

Spiegazione Explanation

I cavalletti posteriori smontabili Accossato consentono di ridurre l'ingombro durante il trasporto. Realizzati in alluminio, sono disponibili in diverse colorazioni. I cavalletti sono venduti con il supporto in gomma a "L" oppure a "V", adatti a qualsiasi moto stradale o da turismo.

Accossato front decomposable stands allow to reduce volume at minimum to ease carriage at best. Made in aluminium, front parts are available in several colours. Stands are supplied with specific brackets, either "L-shaped" (AV001) or with "V-shaped" (AV002) ones, suitable for any on-road & tourism motorcycles.

BRAKE/CLUTCH
MASTER CYLINDERS
 ACCESSORIES
SPARE PARTS
 CNC-WORKED FLUID
RESERVOIR
 FULL CLUTCH
 HYDRAULIC-CLUTCH
TRANFORMATION KIT
 LEVER
 THROTTLE CONTROL
 BRAKE CALIPER
 RACING KIT
 BUTTON PANEL
 LEVER GUARD
 CLIP-ON
 STREET RACING
REARSET
 FUEL CAPS
 STEERING NUT
 CRASH PADS
 Paddock STAND
 MIRROR COVERS
 REAR-VIEW MIRRORS
 FOG LIGHTS KIT
 HANDLEBARS
ACCESSORIES
 HANDLEBARS

SUPPORTI CAVALLETTO

STAND SUPPORT



Codice supporto cavaletto senza protezione

Stand supports without protection

ST001
ST002
ST004

Specifiche tecniche

Technical specifications

M6
M8
M10 X 1,25

Codice supporto cavaletto con protezione

Stand supports with protection

ST006
ST008
ST010

Specifiche tecniche

Technical specifications

M6
M8
M10 X 1,25

Colori / Colours

N 
nero - black

Y 
oro - gold

B 
blu - blue

R 
rosso - red

S 
argento - silver

G 
verde - green

T 
titanio - titanium

- BRAKE/CLUTCH MASTER CYLINDERS
- ACCESSORIES SPARE PARTS
- CNC-WORKED FLUID RESERVOIR
- FULL CLUTCH
- HYDRAULIC-CLUTCH TRANFORMATION KIT
- LEVER
- THROTTLE CONTROL
- BRAKE CALIPER
- RACING KIT
- BUTTON PANEL
- LEVER GUARD
- CLIP-ON
- STREET RACING REARSET
- FUEL CAPS
- STEERING NUT
- CRASH PADS
- PADDOCK STAND
- MIRROR COVERS
- REAR-VIEW MIRRORS
- FOG LIGHTS KIT
- HANDLEBARS ACCESSORIES
- HANDLEBARS

Marca Brand	CC	Modello Model	Anno dal From	Anno al To	Codice supporto cavaletto senza protezione Stand supports without protection	Codice supporto cavaletto con protezione Stand supports with protection	Novità New
APRILIA	125	RS125	1992	2019	ST001	ST006	N
APRILIA	250	RS250	1995	2002	ST001	ST006	N
APRILIA	1000	RSV4	2017	2019	ST001	ST006	N
APRILIA	1000	RSV4 RR EURO 4 ABS	2019	2019	ST001	ST006	N
APRILIA	1000	RSV4 FACTORY - SBK RACING	2009	2010	ST001	ST006	N
APRILIA	1000	RSV4 R	2009	2010	ST001	ST006	N
APRILIA	1000	RSV4 APRC R	2011	2012	ST001	ST006	N
APRILIA	1000	RSV4 FACTORY APRC STD - SE	2011	2012	ST001	ST006	N
APRILIA	1000	RSV4 APRC R ABS	2013	2014	ST001	ST006	N
APRILIA	1000	RSV4 FACTORY APRC ABS	2013	2014	ST001	ST006	N
APRILIA	1000	RSV4 RR RACER PACK	2015	2015	ST001	ST006	N
APRILIA	1000	RSV4 RACING FACTORY LE	2015	2017	ST001	ST006	N
APRILIA	1000	RSV4 RACING FACTORY ABS	2018	2018	ST001	ST006	N
APRILIA	1000	RSV4 RR	2015	2018	ST001	ST006	N
APRILIA	1000	RSV1000	1998	2008	ST001	ST006	N
APRILIA	1000	TUONO1000	2003	2010	ST001	ST006	N
APRILIA	1000	TUONO V4	2010	2014	ST001	ST006	N
APRILIA	1100	TUONO V4 FACTORY SUPERPOLE EURO 4	2019	2019	ST001	ST006	N
APRILIA	1100	TUONO V4 RR EURO 4 ABS	2019	2019	ST001	ST006	N
APRILIA	1100	TUONO V4 R STD - APRC	2011	2013	ST001	ST006	N
APRILIA	1100	TUONO V4 R APRC ABS	2015	2015	ST001	ST006	N
APRILIA	1100	TUONO V4 FACTORY	2015	2017	ST001	ST006	N
APRILIA	1100	RSV4/R/APRC	2009	2018	ST001	ST006	N
APRILIA	1100	TUONO V4 RF ABS	2018	2018	ST001	ST006	N
APRILIA	1100	TUONO V4 RR	2015	2018	ST001	ST006	N
BENELLI	500	LEONCINO 500 / TRAIL	2017	2018	ST001	ST006	N
BMW	1000	S1000R	2009	2016	ST002	ST008	N
BMW	1000	S1000 RR	2009	2018	ST002	ST008	N
DUCATI	899	PANIGALE 899	2014	2015	ST001	ST006	N
DUCATI	959	PANIGALE 959	2017	2019	ST001	ST006	N
DUCATI	959	PANIGALE CORSE 959	2018	2019	ST001	ST006	N
HONDA	1000	CBR1000 RR	2009	2016	ST002	ST008	N
HONDA	600	CBR600 RR	2003	2015	ST002	ST008	N
HONDA	600	CBR600F	1995	2013	ST002	ST008	N
HONDA	600	HORNET 600	1998	2013	ST002	ST008	N
HONDA	900	CBR 900	1994	2003	ST002	ST008	N
HONDA	900	HORNET 900	2002	2006	ST002	ST008	N
HONDA	1000	VTR1000 SP1/2	2000	2006	ST002	ST008	N
HONDA	1000	CBR1000 R / RR	2004	2018	ST002	ST008	N
KAWASAKI	250	NINJA250 R	2007	2013	ST004	ST010	N
KAWASAKI	300	NINJA300 R	2012	2017	ST004	ST010	N
KAWASAKI	400	NINJA400	2018	2020	ST004	ST010	N
KAWASAKI	636	ZX 6-636 R / RR / ABS	1998	2008	ST004	ST010	N
KAWASAKI	636	ZX 6-636 R / RR / ABS	2013	2017	ST002	ST008	N
KAWASAKI	650	Z650	2017	2019	ST002	ST008	N
KAWASAKI	650	VERSYS 650	2006	2018	ST004	ST010	N
KAWASAKI	650	ER6N	2005	2016	ST004	ST010	N
KAWASAKI	650	Z650	2017	2018	ST002	ST008	N
KAWASAKI	750	Z750	2003	2013	ST004	ST010	N
KAWASAKI	800	Z800	2013	2016	ST002	ST008	N
KAWASAKI	900	ZX9 R	1998	2005	ST004	ST010	N
KAWASAKI	900	Z900	2017	2018	ST002	ST008	N
KAWASAKI	1000	ZX10-R	2011	2019	ST002	ST008	N

BRAKE/CLUTCH
MASTER CYLINDERS
 ACCESSORIES
SPARE PARTS
 CNC-WORKED FLUID
RESERVOIR
 FULL CLUTCH
 HYDRAULIC-CLUTCH
TRANFORMATION KIT
 LEVER
 THROTTLE CONTROL
 BRAKE CALIPER
 RACING KIT
 BUTTON PANEL
 LEVER GUARD
 CLIP-ON
 STREET RACING
REARSET
 FUEL CAPS
 STEERING NUT
 CRASH PADS
 PADDOCK STAND
 MIRROR COVERS
 REAR-VIEW MIRRORS
 FOG LIGHTS KIT
 HANDLEBARS
ACCESSORIES
 HANDLEBARS

Marca Brand	CC	Modello Model	Anno dal From	Anno al To	Codice supporto cavaletto senza protezione Stand supports without protection	Codice supporto cavaletto con protezione Stand supports with protection	Novità New
KAWASAKI	1000	ZX10 R	2004	2010	ST004	ST010	N
KAWASAKI	1000	Z1000 SX	2007	2012	ST004	ST010	N
KAWASAKI	1000	Z1000	2007	2013	ST004	ST010	N
KAWASAKI	1000	Z1000	2014	2018	ST002	ST008	N
KAWASAKI	1000	ZX10 R	2011	2018	ST002	ST008	N
KAWASAKI	1000	Z1000 SX	2013	2018	ST002	ST008	N
KAWASAKI	1400	ZZR1400 R	2006	2018	ST004	ST010	N
KTM	390	DUKE 390	2017	2018	ST005	ST007	N
KTM	450	450 SMR			ST005	ST007	N
KTM	690	690 DUKE	2010	2017	ST005	ST007	N
KTM	690	690 ENDURO / R	2010	2017	ST005	ST007	N
KTM	690	690 SMC / R	2010	2017	ST005	ST007	N
KTM	690	690 SUPERMOTO / R	2010	2017	ST005	ST007	N
KTM	690	DUKE 690	2007	2018	ST005	ST007	N
KTM	701	701 SUPERMOTO			ST005	ST007	N
KTM	790	DUKE 790	2018	2019	ST005	ST007	N
KTM	790	790 DUKE			ST005	ST007	N
KTM	950	950 SUPERMOTO	2010	2019	ST005	ST007	N
KTM	990	990 SUPER DUKE / R	2005	2014	ST005	ST007	N
KTM	990	990 ADVENTURE			ST005	ST007	N
KTM	990	990 SM T			ST005	ST007	N
KTM	990	990 SUPERMOTO / R			ST005	ST007	N
SUZUKI	1000	GSX-R 1000	2017	2018	ST002	ST008	N
SUZUKI	1000	GSX-R 1000 A / RA / RZAL L9	2017	2018	ST002	ST008	N
SUZUKI	600	GSX600 R	2001	2005	ST002	ST008	N
SUZUKI	600	GSX600 R	2006	2010	ST004	ST010	N
SUZUKI	600	GSR 600	2006	2012	ST002	ST008	N
SUZUKI	650	SV 650	2016	2018	ST002	ST008	N
SUZUKI	750	GSX750 R	2001	2005	ST002	ST008	N
SUZUKI	750	GSX750 R	2006	2010	ST004	ST010	N
SUZUKI	750	GSR750	2010	2016	ST002	ST008	N
SUZUKI	750	GSXS750	2017	2018	ST002	ST008	N
SUZUKI	900	GLADIUS 650	2009	2015	ST002	ST008	N
SUZUKI	1000	GSX1000R	2005	2006	ST004	ST010	N
SUZUKI	1000	GSX1000 R	2007	2018	ST002	ST008	N
SUZUKI	1000	GSX-S 1000	2015	2018	ST002	ST008	N
SUZUKI	1100	GSX600 R	2011	2017	ST002	ST008	N
SUZUKI	1100	GSX750 R	2011	2017	ST002	ST008	N
SUZUKI	1300	B-KING	2007	2012	ST004	ST010	N
SUZUKI	1300	GSX1300 R HAYABUSA	2008	2017	ST004	ST010	N
TRIUMPH	675	DAYTONA 675	2010	2015	ST002	ST008	
TRIUMPH	675	STREET TRIPLE 675	2010	2015	ST002	ST008	
TRIUMPH	675	DAYTONA 675 / R	2006	2016	ST002	ST008	N
TRIUMPH	675	STREET TRIPLE / R	2007	2016	ST002	ST008	N
TRIUMPH	765	STREET TRIPLE 765 RS	2017	2019	ST002	ST008	N
YAMAHA	125	R125	2008	2018	ST001	ST006	N
YAMAHA	300	R300 / R320	2015	2018	ST001	ST006	N
YAMAHA	300	YZF-R3	2015	2018	ST001	ST006	N
YAMAHA	600	YZF-R6	2017	2019	ST001	ST006	N
YAMAHA	600	FZ6	2004	2016	ST001	ST006	N
YAMAHA	600	YZF-R6	1999	2018	ST001	ST006	N
YAMAHA	600	XJ6	2009	2015	ST001	ST006	N
YAMAHA	600	YZF-R6	2017	2018	ST001	ST006	N

BRAKE/CLUTCH
MASTER CYLINDERS

ACCESSORIES
SPARE PARTS

CNC-WORKED FLUID
RESERVOIR

FULL CLUTCH

HYDRAULIC-CLUTCH
TRANFORMATION KIT

LEVER

THROTTLE CONTROL

BRAKE CALIPER

RACING KIT

BUTTON PANEL

LEVER GUARD

CLIP-ON

STREET RACING
REARSET

FUEL CAPS

STEERING NUT

CRASH PADS

PADDOCK STAND

MIRROR COVERS

REAR-VIEW MIRRORS

FOG LIGHTS KIT

HANDLEBARS
ACCESSORIES

HANDLEBARS

Marca Brand	CC	Modello Model	Anno dal From	Anno al To	Codice supporto cavaletto senza protezione Stand supports without protection	Codice supporto cavaletto con protezione Stand supports with protection	Novità New
YAMAHA	700	MT-07	2014	2016	ST001	ST006	N
YAMAHA	800	FZ8	2010	2018	ST001	ST006	N
YAMAHA	900	MT-09 TRACER	2016	2019	ST001	ST006	N
YAMAHA	900	MT-09	2017	2020	ST001	ST006	N
YAMAHA	900	MT-09	2013	2016	ST001	ST006	N
YAMAHA	1000	FAZER 1000	2000	2019	ST001	ST006	N
YAMAHA	1000	FZ1	2006	2016	ST001	ST006	N
YAMAHA	1000	YZF-R1	1998	2016	ST001	ST006	N
YAMAHA	1000	YZF-R1	2015	2018	ST001	ST006	N
YAMAHA	1000	MT10	2016	2018	ST001	ST006	N

BRAKE/CLUTCH
MASTER CYLINDERS

ACCESSORIES
SPARE PARTS

CNC-WORKED FLUID
RESERVOIR

FULL CLUTCH

HYDRAULIC-CLUTCH
TRANFORMATION KIT

LEVER

THROTTLE CONTROL

BRAKE CALIPER

RACING KIT

BUTTON PANEL

LEVER GUARD

CLIP-ON

STREET RACING
REARSET

FUEL CAPS

STEERING NUT

CRASH PADS

PADDOCK STAND

MIRROR COVERS

REAR-VIEW MIRRORS

FOG LIGHTS KIT

HANDLEBARS
ACCESSORIES

HANDLEBARS

TAPPI SPECCHIETTI

MIRROR COVERS



Colori / Colours

N ●
nero - black

Y ●
oro - gold

B ●
blu - blue

R ●
rosso - red

S ●
argento - silver

G ●
verde - green

T ●
titanio - titanium

BRAKE/CLUTCH
MASTER CYLINDERS
ACCESSORIES
SPARE PARTS
CNC-WORKED FLUID
RESERVOIR
FULL CLUTCH
HYDRAULIC-CLUTCH
TRANSFORMATION KIT
LEVER
THROTTLE CONTROL
BRAKE CALIPER
RACING KIT
BUTTON PANEL
LEVER GUARD
CLIP-ON
STREET RACING
REARSET
FUEL CAPS
STEERING NUT
CRASH PADS
PADDOCK STAND
MIRROR COVERS
REAR-VIEW MIRRORS
FOG LIGHTS KIT
HANDLEBARS
ACCESSORIES
HANDLEBARS

Applicazioni / Application list

Marca Brand	CC	Modello Model	Anno dal From	Anno al To	Codice Code	Novità New
APRILIA	1000	RSV4	2009	2019	MC001	N
BMW	1000	S1000 RR	2009	2018	MC002	
HONDA	250	CB R250 R	2011	2014	MC003	
HONDA	600	CBR 600 RR	2004	2016	MC003	
HONDA	600	CBR 600 F	1999	2006	MC003	
HONDA	600	HORNET 600 S	1998	2006	MC003	
HONDA	800	VFR 800	2007	2007	MC003	
HONDA	929	CBR929 RR	2001	2002	MC003	
HONDA	954	CBR954 RR	2003	2004	MC003	
HONDA	1000	VTR SP1 / SP2	2001	2005	MC003	
HONDA	1000	CBR 1000 RR	2004	2007	MC003	
HONDA	1000	CBR 1000 RR	2008	2018	MC004	
HONDA	1000	VTR 1000 F	2001	2005	MC003	N
KAWASAKI	600	ZX6 RR	2003	2004	MC002	N
KAWASAKI	600	ZX6 R	2005	2008	MC003	
KAWASAKI	600	ZX6 R	2009	2017	MC005	
KAWASAKI	636	ZX6 R	2003	2004	MC002	
KAWASAKI	636	ZX6 R	2005	2008	MC003	
KAWASAKI	900	ZX9 R	1994	2003	MC002	
KAWASAKI	1000	ZX10 R	2004	2007	MC003	
KAWASAKI	1000	ZX10 R	2011	2015	MC005	
KAWASAKI	1000	Z1000 SX	2011	2018	MC003	N
MOTO GUZZI	1064	V11 SEMI FAIRING	2001	2005	MC002	
MOTO GUZZI	1064	V11 LE MANS CORSA	2001	2005	MC002	
MV AGUSTA	675	F3 675	2012	2019	MC003	
MV AGUSTA	800	F3 800	2012	2019	MC003	
SUZUKI	600	GSX-R 600	2001	2017	MC006	
SUZUKI	650	SV 650 S	2000	2006	MC006	
SUZUKI	750	GSXR 750	2001	2017	MC006	
SUZUKI	1000	GSXR 1000	2001	2016	MC006	
SUZUKI	1000	SV 1000 S	2003	2006	MC006	
SUZUKI	1300	GSX -R 1300	1999	2009	MC006	
SUZUKI	1300	GSX -R1300R / HAYABUSA	2008	2017	MC006	N
TRIUMPH	675	DAYTONA 675 R	2014	2015	MC007	
YAMAHA	125	YZF-R125	2008	2018	MC002	
YAMAHA	530	TMAX 530	2012	2016	MC008	
YAMAHA	600	FZ6	2004	2007	MC002	
YAMAHA	600	YZF-R6	1999	2007	MC002	
YAMAHA	1000	YZF-R1	1998	2006	MC002	
YAMAHA	1000	YZF-R1	2007	2014	MC002	
YAMAHA	1000	YZF-R1	2015	2019	MC009	N
YAMAHA	1000	FZ1	2006	2012	MC002	

BRAKE/CLUTCH
MASTER CYLINDERS
 ACCESSORIES
SPARE PARTS
 CNC-WORKED FLUID
RESERVOIR
 FULL CLUTCH
 HYDRAULIC-CLUTCH
TRANFORMATION KIT
 LEVER
 THROTTLE CONTROL
 BRAKE CALIPER
 RACING KIT
 BUTTON PANEL
 LEVER GUARD
 CLIP-ON
 STREET RACING
REARSET
 FUEL CAPS
 STEERING NUT
 CRASH PADS
 PADDOCK STAND
 MIRROR COVERS
 REAR-VIEW MIRRORS
 FOG LIGHTS KIT
 HANDLEBARS
ACCESSORIES
 HANDLEBARS

SPECCHIETTI RETROVISORI

REAR-VIEW MIRRORS

MR001



MR002



MR003

- BRAKE/CLUTCH MASTER CYLINDERS
- ACCESSORIES SPARE PARTS
- CNC-WORKED FLUID RESERVOIR
- FULL CLUTCH
- HYDRAULIC-CLUTCH TRANSFORMATION KIT
- LEVER
- THROTTLE CONTROL
- BRAKE CALIPER
- RACING KIT
- BUTTON PANEL
- LEVER GUARD
- CLIP-ON
- STREET RACING REARSET
- FUEL CAPS
- STEERING NUT
- CRASH PADS
- Paddock STAND
- MIRROR COVERS
- REAR-VIEW MIRRORS
- FOG LIGHTS KIT
- HANDLEBARS ACCESSORIES
- HANDLEBARS

Codice Reference	Descrizione Description	Caratteristiche tecniche Technical details
MR001	Specchietto retrovisore universale per moto stradali Universal rear-view mirror for on-road motorcycles	Dimensioni/Dimension: 110x58 mm M10x1,25 Adattatori inclusi/Adapter included: M8x1,25 Non omologato / Not homologates

Colori / Colours

N ●
nero - black

Codice Reference	Descrizione Description	Caratteristiche tecniche Technical details
MR002	Specchietto retrovisore CNC Accossato con indicatore di direzione integrato Accossato CNC-worked rear-view mirror with integrated direction indicator	Dimensioni/Dimension: 134x80 mm M10x1,25 Adattatori/Adapter: M10x1,25 SX + M8x1,25 + M8x1,25 SX Superficie riflettente/Reflective surface: Azzurrata/Blue-tinted mirror Tipo luce/Light type: Led Non omologato / Not homologates

Colori / Colours

N ●
nero - black

Codice Reference	Descrizione Description	Caratteristiche tecniche Technical details
MR003	Specchietto retrovisore CNC con inserti colorati Accossato CNC-worked rear-view mirror with integrated coloured insert	Dimensioni/Dimension: 134x80 mm M10x1,25 Adattatori/Adapter: M10x1,25 SX + M8x1,25 + M8x1,25 SX Superficie riflettente/Reflective surface: Azzurrata/Blue-tinted mirror Inserti/Insets: CNC / CNC Worked Non omologato / Not homologates

Colori / Colours

N ●
nero - black

Y ●
oro - gold

B ●
blu - blue

R ●
rosso - red

S ●
argento - silver

G ●
verde - green

T ●
titanio - titanium

BRAKE/CLUTCH
MASTER CYLINDERS
ACCESSORIES
SPARE PARTS
CNC-WORKED FLUID
RESERVOIR
FULL CLUTCH
HYDRAULIC-CLUTCH
TRANFORMATION KIT
LEVER
THROTTLE CONTROL
BRAKE CALIPER
RACING KIT
BUTTON PANEL
LEVER GUARD
CLIP-ON
STREET RACING
REARSET
FUEL CAPS
STEERING NUT
CRASH PADS
PADDOCK STAND
MIRROR COVERS
REAR-VIEW MIRRORS
FOG LIGHTS KIT
HANDLEBARS
ACCESSORIES
HANDLEBARS

Applicazioni / Application list

Marca Brand	CC	Modello Model	Dal From	Al To	MR002 / MR003	MR001	Novità New	Marca Brand	CC	Modello Model	Dal From	Al To	MR002 / MR003	MR001	Novità New
ADIVA	125	AD 125	2007	2009	X	X	N	APRILIA	250	SPORT CITY CUBE 250	2009	2012	X		N
ADIVA	200	AD 200	2007	2007	X	X	N	APRILIA	250	SCARABEO LIGHT 250	2006	2008	X		N
ADIVA	250	AD 250	2007	2007	X	X	N	APRILIA	250	SPORT CITY 250	2004	2008	X		N
ADIVA	400	AD 400	2007	2007	X	X	N	APRILIA	300	SPORT CITY STREET 300	2012	2012	X		N
APRILIA	50	SX 50	2006	2019	X		N	APRILIA	300	SCARABEO LIGHT 300	2009	2010	X		N
APRILIA	50	SCARABEO CLASSIC 2T CARB. EURO4	2018	2018	X			APRILIA	300	SPORT CITY CUBE 300	2009	2009	X		N
APRILIA	50	SCARABEO STREET 2T CARB. EURO4	2018	2018	X			APRILIA	400	SCARABEO LIGHT 400	2006	2008	X		N
APRILIA	50	SCARABEO 4T 4V	2010	2017	X			APRILIA	450	RXV 4.5	2009	2011	X	X	
APRILIA	50	SCARABEO 2T	2014	2014	X			APRILIA	450	SXV 4.5	2006	2011	X	X	N
APRILIA	50	SR MOTARD 50	2012	2014	X	X		APRILIA	450	RXV 4.5 PIKES PEAK	2009	2009	X	X	N
APRILIA	50	RX	2006	2013	X		N	APRILIA	450	SXV 4.5 PIKES PEAK	2009	2009	X	X	N
APRILIA	50	SCARABEO EURO2 (MOTORE PIAGGIO)	2010	2012	X			APRILIA	450	RXV 4.5 REPLICA	2008	2008	X	X	N
APRILIA	50	SCARABEO 2T NET	2009	2010	X			APRILIA	450	SXV 4.5 REPLICA	2008	2008	X	X	N
APRILIA	50	SCARABEO 4T 4V NET	2009	2010	X			APRILIA	500	SCARABEO LIGHT 500	2006	2008	X		N
APRILIA	50	SCARABEO 4T RESTYLING EURO3	2006	2009	X			APRILIA	500	SCARABEO 500	2003	2006	X		N
APRILIA	50	SCARABEO QUATTRO	2009	2009	X		N	APRILIA	500	SCARABEO 500	2003	2006	X		N
APRILIA	50	SCARABEO STREET 2T	2005	2009	X		N	APRILIA	500	ATLANTIC	2001	2004	X		N
APRILIA	50	MOJITO 50	2004	2008	X		N	APRILIA	550	RXV 5.5	2006	2011	X	X	N
APRILIA	50	SONIC	1998	2008	X			APRILIA	550	SXV 5.5	2006	2011	X	X	N
APRILIA	50	SONIC GP	1998	2008	X			APRILIA	550	RXV 5.5 PIKES PEAK	2009	2009	X	X	N
APRILIA	50	SCARABEO 4T	2002	2006	X		N	APRILIA	550	SXV 5.5 PIKES PEAK	2009	2009	X	X	N
APRILIA	50	SCARABEO 2T	1993	2005	X		N	APRILIA	550	RXV 5.5 REPLICA	2008	2008	X	X	N
APRILIA	50	SCARABEO DITECH	2001	2004	X		N	APRILIA	550	SXV 5.5 REPLICA	2008	2008	X	X	N
APRILIA	50	MOJITO CUSTOM 50	1999	2003	X		N	APRILIA	650	PEGASO IE	2001	2004	X	X	N
APRILIA	50	MOJITO RETRO 50	1999	2003	X		N	APRILIA	650	PEGASO IE TUSCANY TIBET RAID	2001	2004	X	X	N
APRILIA	50	RALLY LIQUID COOLED	1993	1999	X		N	APRILIA	650	PEGASO 3	1997	2000	X	X	N
APRILIA	50	SCARABEO 50	1993	1997	X		N	APRILIA	650	MOTO'	1995	1999	X	X	N
APRILIA	100	SCARABEO 4T	2001	2014	X		N	APRILIA	650	PEGASO 650	1992	1996	X	X	N
APRILIA	100	SCARABEO 4T NET	2009	2010	X			APRILIA	660	PEGASO FACTORY	2005	2013	X	X	N
APRILIA	100	SCARABEO 4T RESTYLING	2006	2009	X			APRILIA	660	PEGASO STRADA	2005	2013	X	X	N
APRILIA	100	SCARABEO 2T (MOTORE MINARELLI)	2000	2000	X		N	APRILIA	660	PEGASO TRAIL	2005	2013	X	X	N
APRILIA	100	SCARABEO 2T (MOTORE YAMAHA)	2000	2000	X		N	APRILIA	750	DORSODURO 750	2008	2016	X	X	N
APRILIA	125	TUONO 125 EURO 4 ABS	2020	2020	X	X		APRILIA	750	SHIVER	2007	2016	X	X	N
APRILIA	125	TUONO 125 ABS	2010	2018	X	X		APRILIA	750	DORSODURO FACTORY	2010	2013	X	X	N
APRILIA	125	SR MOTARD 125	2012	2014	X	X	N	APRILIA	750	SHIVER GT	2009	2009	X	X	N
APRILIA	125	SPORT CITY STREET 125	2012	2012	X		N	APRILIA	850	MANA GT	2009	2016	X	X	N
APRILIA	125	SCARABEO IE	2009	2010	X		N	APRILIA	850	MANA	2007	2011	X	X	N
APRILIA	125	SCARABEO LIGHT 125	2006	2010	X		N	APRILIA	900	SHIVER EURO 4 ABS NAVI	2019	2019	X	X	
APRILIA	125	SPORT CITY CUBE 125	2009	2010	X		N	APRILIA	900	DORSODURO 900 EURO 4 ABS	2018	2018	X	X	N
APRILIA	125	MOJITO 125	2003	2008	X		N	APRILIA	900	SHIVER 900	2017	2018	X	X	
APRILIA	125	SPORT CITY 125	2004	2008	X		N	APRILIA	900	DORSODURO 900	2017	2017	X	X	
APRILIA	125	SCARABEO EURO3	2006	2007	X		N	APRILIA	1000	TUONO V4 R APRC ABS	2014	2014	X	X	
APRILIA	125	SCARABEO 125	2003	2006	X		N	APRILIA	1000	TUONO V4 R STD - APRC	2011	2013	X	X	
APRILIA	125	SCARABEO (MOTORE ROTAX)	1999	2003	X		N	APRILIA	1000	TUONO V4R APRC	2011	2013	X	X	N
APRILIA	125	MOJITO CUSTOM 125	1999	2001	X		N	APRILIA	1000	TUONO V4R STD	2011	2013	X	X	N
APRILIA	125	MOJITO RETRO 125	1999	2001	X		N	APRILIA	1000	TUONO FACTORY	2006	2009	X	X	N
APRILIA	125	PEGASO 125	1989	1994	X	X	N	APRILIA	1000	TUONO R	2006	2009	X	X	N
APRILIA	125	RX WIND	1989	1993	X	X	N	APRILIA	1000	ETV CAPO NORD	2001	2007	X	X	N
APRILIA	125	TUAREG RALLY	1989	1992	X	X	N	APRILIA	1000	ETV RALLY	2001	2003	X	X	N
APRILIA	125	ETX	1985	1987	X		N	APRILIA	1100	TUONO V4 FACTORY SUPERPOLE EURO 4	2019	2019	X	X	
APRILIA	150	MOJITO 150	2003	2008	X		N	APRILIA	1100	TUONO V4 RR EURO 4 ABS	2019	2019	X	X	
APRILIA	150	SCARABEO 150	2003	2006	X		N	APRILIA	1100	TUONO V4 RF ABS	2018	2018	X	X	
APRILIA	200	SPORT CITY CUBE 200	2009	2009	X		N	APRILIA	1100	TUONO V4 RR	2015	2018	X	X	
APRILIA	200	SCARABEO LIGHT 200	2006	2008	X		N	APRILIA	1100	TUONO V4 FACTORY	2015	2017	X	X	
APRILIA	200	SPORT CITY 200	2004	2008	X		N	APRILIA	1200	CAPONORD 1200	2013	2016	X	X	
APRILIA	200	SCARABEO 200	2003	2006	X		N	APRILIA	1200	DORSODURO 1200	2011	2016	X	X	N

- BRAKE/CLUTCH MASTER CYLINDERS
- ACCESSORIES SPARE PARTS
- CNC-WORKED FLUID RESERVOIR
- FULL CLUTCH
- HYDRAULIC-CLUTCH TRANFORMATION KIT
- LEVER
- THROTTLE CONTROL
- BRAKE CALIPER
- RACING KIT
- BUTTON PANEL
- LEVER GUARD
- CLIP-ON
- STREET RACING REARSET
- FUEL CAPS
- STEERING NUT
- CRASH PADS
- PADDOCK STAND
- MIRROR COVERS
- REAR-VIEW MIRRORS
- FOG LIGHTS KIT
- HANDLEBARS ACCESSORIES
- HANDLEBARS

Marca Brand	CC	Modello Model	Dal From	Al To	MR002 / MR003	MR001	Novità New	Marca Brand	CC	Modello Model	Dal From	Al To	MR002 / MR003	MR001	Novità New
BENELLI	50	PEPE 4T	2012	2013	X		N	BMW	650	G650 XCHALLENGE	2005	2008	X	X	N
BENELLI	50	PEPE 2T	2010	2012	X		N	BMW	650	G650 XMOTO	2006	2008	X	X	N
BENELLI	50	PEPE CLASSIC	2007	2012	X		N	BMW	650	F650 GS DAKAR	2000	2007	X	X	N
BENELLI	50	PEPE LX	2003	2009	X		N	BMW	650	R65	1981	1995	X	X	N
BENELLI	50	NAKED	2002	2004	X		N	BMW	650	R65 GS	1980	1992	X	X	N
BENELLI	50	NAKED MORINI	2003	2004	X		N	BMW	750	K75 C	1985	1991	X	X	N
BENELLI	50	RR MORINI	2003	2004	X		N	BMW	750	K75	1983	1988	X	X	N
BENELLI	50	ST 50 MORINI	2003	2003	X		N	BMW	800	R80 GS	1985	1995	X	X	N
BENELLI	50	K2 AIR COOLED	1998	2001	X		N	BMW	800	R80 R	1991	1994	X	X	N
BENELLI	50	K2 LIQUID COOLED	1998	2001	X		N	BMW	800	R80 BOXER	1980	1992	X	X	N
BENELLI	50	PEPE	1999	2001	X		N	BMW	800	R80 ST	1980	1985	X	X	N
BENELLI	50	RR 50	1999	2001	X		N	BMW	850	R850 R	2002	2007	X	X	N
BENELLI	50	ST 50	1999	2001	X		N	BMW	850	R850 C [59C1]	1997	2000	X	X	N
BENELLI	50	GT 50	1998	1999	X		N	BMW	850	R850 C [59C2, 59C3]	1997	2000	X	X	N
BENELLI	50	RACING	1998	1999	X		N	BMW	1000	S 1000 R	2014	2014	X		
BENELLI	50	SP	1999	1999	X		N	BMW	1000	S 1000 XR	2014	2014	X		
BENELLI	50	SPORT	1998	1999	X		N	BMW	1000	R100 GS	1987	1995	X	X	N
BENELLI	100	K2	1999	2001	X		N	BMW	1000	R100 R	1991	1994	X	X	N
BENELLI	125	VELVET 125	2012	2012	X		N	BMW	1000	K100	1983	1988	X	X	N
BENELLI	125	VELVET TOURING 125	2008	2010	X		N	BMW	1000	R100 GS	1976	1984	X	X	N
BENELLI	125	VELVET 125	1999	2003	X		N	BMW	1100	R1100 S	1997	2005	X	X	N
BENELLI	125	VELVET TOURING 125	2002	2003	X		N	BMW	1150	R1150 R	2000	2006	X	X	N
BENELLI	150	VELVET 150	2010	2010	X		N	BMW	1150	R1150 GS ADVENTURE	2001	2005	X	X	N
BENELLI	150	VELVET 150	1999	2003	X		N	BMW	1150	R1150 R ROCKSTER	2002	2005	X	X	N
BENELLI	150	VELVET TOURING 150	2002	2003	X		N	BMW	1150	R1150 RS	2001	2004	X	X	N
BENELLI	250	VELVET TOURING 250	2002	2003	X		N	BMW	1150	R1150 GS	1999	2003	X	X	N
BENELLI	250	VELVET 250	1999	2001	X		N	BMW	1170	HP2 MEGAMOTO	2007	2007	X	X	
BENELLI	400	VELVET 400	2003	2004	X		N	BMW	1200	R NINET	2014	2014	X		
BENELLI	500	LEONCINO 500	2016	2019	X		N	BMW	1200	HP2 ENDURO	2007	2008	X	X	N
BENELLI	500	LEONCINO 500 TRAIL	2017	2019	X		N	BMW	1200	R1200 ST	2003	2007	X	X	N
BENELLI	500	TRK 502	2016	2019	X		N	BMW	1200	K1200 GT	2002	2005	X	X	N
BENELLI	500	TRK 502 X	2016	2019	X		N	BMW	1200	K1200 RS	1996	2005	X	X	N
BETA	50	ARK AIR COOLED	1996	2012	X		N	BMW	1200	R1200 C [59C1]	1996	2004	X	X	N
BETA	50	ARK LIQUID COOLED	1996	2012	X		N	BMW	1200	R1200 C [59C2, 59C3]	1996	2004	X	X	N
BETA	50	RR MOTARD	2005	2009	X	X	N	BMW	1200	R1200 C INDEPENDENT [59C1]	2000	2004	X	X	N
BETA	50	RR AM6	2005	2008	X	X	N	BMW	1200	R1200 C INDEPENDENT [59C2, 59C3]	2000	2004	X	X	N
BETA	50	RR ENDURO	2005	2008	X	X	N	BMW	1200	R1200 C MONTAUK [59C1]	2003	2004	X	X	N
BETA	50	EIKON 50	1999	2005	X		N	BMW	1200	R1200 C MONTAUK [59C2, 59C3]	2003	2004	X	X	N
BETA	50	RR 50	1999	2004	X	X	N	BMW	1200	R1200GS	2004	2004	X		
BETA	50	SUPER MOTARD	1998	2002	X	X	N	CAGIVA	50	W4	1992	1995	X	X	N
BETA	50	RR6	1997	1998	X	X	N	CAGIVA	125	RAPTOR 125	2001	2007	X	X	N
BETA	50	ST 50	1996	1998	X	X	N	CAGIVA	125	W8	1993	1998	X	X	N
BETA	50	QUADRA CHRONO 50	1996	1996	X		N	CAGIVA	125	W8 FA	1994	1998	X	X	N
BETA	50	RK6	1993	1996	X	X	N	CAGIVA	350	W12	1993	1995	X	X	N
BETA	125	EIKON 125	1999	2003	X		N	CAGIVA	500	CANYON	1996	2002	X	X	N
BETA	125	REV3 125	1994	1999	X	X	N	CAGIVA	600	RIVER 600	1995	1999	X	X	N
BETA	150	EIKON 150	2000	2002	X		N	CAGIVA	650	RAPTOR 650 IE	2006	2006	X	X	N
BETA	200	REV3 200	1994	1999	X	X	N	CAGIVA	650	RAPTOR 650	2001	2005	X	X	N
BETA	250	REV3 250	1994	1999	X	X	N	CAGIVA	650	V-RAPTOR 650	2001	2005	X	X	N
BETA	250	TECHNO	1994	1999	X	X	N	CAGIVA	900	GRAN CANYON	1998	2000	X	X	N
BETA	270	REV3 270	1994	1999	X	X	N	CAGIVA	1000	RAPTOR 1000	2000	2005	X	X	N
BETA	350	EURO	2001	2002	X		N	CAGIVA	1000	V-RAPTOR 1000	2000	2005	X	X	N
BETA	350	JONATHAN	2001	2002	X		N	CAGIVA	1000	XTRA-RAPTOR 1000	2000	2005	X	X	N
BMW	450	R45	1981	1981	X	X	N	CAGIVA	1000	NAVIGATOR	2000	2004	X	X	N
BMW	450	R45 N	1981	1981	X	X	N	DAELIM	50	SJ S-FIVE	2006	2012	X	X	N
BMW	650	G650 GS	2008	2010	X	X	N	DAELIM	50	SE CORDI	2004	2009	X	X	N
BMW	650	G650 XCOUNTRY	2007	2009	X	X	N	DAELIM	50	SJ A E-FIVE	2006	2009	X	X	N
BMW	650	F650 GS	2000	2008	X	X	N	DAELIM	50	SJ R A-FOUR	2006	2009	X	X	N

BRAKE/CLUTCH
 MASTER CYLINDERS
 ACCESSORIES
 SPARE PARTS
 CNC-WORKED FLUID
 RESERVOIR
 FULL CLUTCH
 HYDRAULIC-CLUTCH
 TRANFORMATION KIT
 LEVER
 THROTTLE CONTROL
 BRAKE CALIPER
 RACING KIT
 BUTTON PANEL
 LEVER GUARD
 CLIP-ON
 STREET RACING
 REARSET
 FUEL CAPS
 STEERING NUT
 CRASH PADS
 PADDOCK STAND
 MIRROR COVERS
 REAR-VIEW MIRRORS
 FOG LIGHTS KIT
 HANDLEBARS
 ACCESSORIES
 HANDLEBARS

Marca Brand	CC	Modello Model	Dal From	Al To	MR002 / MR003	MR001	Novità New	Marca Brand	CC	Modello Model	Dal From	Al To	MR002 / MR003	MR001	Novità New
DAELIM	125	SN B-BONE	2009	2013	X	X	N	DERBI	125	TERRA 4T/4T ADVENTURE	2007	2009	X		N
DAELIM	125	S3 FI	2010	2010	X	X	N	DERBI	125	BOULEVARD 4T 125	2008	2008	X	X	N
DAELIM	125	S1 EU	2007	2009	X		N	DERBI	125	GP1 LOW SEAT 4T 125	2007	2008	X		N
DAELIM	125	S2 125	2006	2009	X	X	N	DERBI	125	GPR NUDE 125	2004	2008	X		N
DAELIM	125	S2 FI 125	2007	2009	X	X	N	DERBI	125	SENDA SM/R	2004	2007	X		N
DAELIM	125	SQ 125	2006	2009	X	X	N	DERBI	125	GP1 125	2006	2006	X		N
DAELIM	125	SQ FI 125	2007	2009	X	X	N	DERBI	125	GPR NUDE 125 NUDE SPORT	2004	2006	X		N
DAELIM	125	VL DAYSTAR	1999	2009	X	X	N	DERBI	150	BOULEVARD 4T 150	2010	2010	X	X	N
DAELIM	125	VL FI DAYSTAR	2007	2009	X	X	N	DERBI	150	GP1 LOW SEAT 4T 150	2007	2008	X		N
DAELIM	125	VL L DAYSTAR	2007	2009	X	X	N	DERBI	250	RAMBLA 250	2008	2009	X		N
DAELIM	125	VS EVOLUTION	2007	2008	X	X	N	DERBI	250	GP1 250	2006	2007	X		N
DAELIM	125	SG TRANS UP	2007	2007	X	X	N	DERBI	300	RAMBLA 300	2010	2011	X		N
DAELIM	125	NS 125	1997	2002	X	X	N	DUCATI	400	MONSTER 400	2000	2001	X		N
DAELIM	250	S2 250	2006	2009	X	X	N	DUCATI	400	MONSTER 400	1995	1997	X		N
DAELIM	250	S2 FI 250	2007	2009	X	X	N	DUCATI	600	MONSTER 600	1993	2001	X		N
DAELIM	250	SQ 250	2006	2009	X	X	N	DUCATI	600	MONSTER 600 CITY	1999	1999	X		N
DAELIM	250	SQ FI 250	2007	2009	X	X	N	DUCATI	600	MONSTER 600 DARK	1998	1999	X		N
DAELIM	250	ET 250	2005	2007	X		N	DUCATI	620	MULTISTRADA 620	2006	2006	X		N
DAELIM	300	ET 300	2005	2007	X		N	DUCATI	620	MULTISTRADA 620 DARK	2006	2006	X		N
DERBI	50	SENDA SM/R DRD PRO	2005	2011	X		N	DUCATI	696	MONSTER 20TH 696	2013	2013	X		N
DERBI	50	ATLANTIS 2T	2010	2010	X		N	DUCATI	696	MONSTER 696	2008	2012	X		N
DERBI	50	ATLANTIS 2T EURO 2	2007	2009	X		N	DUCATI	696	MONSTER 696 PLUS	2009	2009	X		N
DERBI	50	ATLANTIS 2T LC	1999	2009	X		N	DUCATI	750	MONSTER 750	1996	2001	X		N
DERBI	50	ATLANTIS 2T O2	1999	2009	X		N	DUCATI	750	MONSTER 750 CITY	1999	1999	X		N
DERBI	50	BOULEVARD 2T 50	2009	2009	X	X	N	DUCATI	750	MONSTER 750 DARK	1999	1999	X		N
DERBI	50	BOULEVARD 4T 50	2009	2009	X	X	N	DUCATI	796	MONSTER 20TH 796	2013	2013	X		N
DERBI	50	GP1 OPEN	2006	2009	X		N	DUCATI	796	MONSTER 796	2010	2012	X		N
DERBI	50	SENDA HYP DRD EVO	2008	2009	X	X	N	DUCATI	796	MONSTER 796 ABS	2011	2012	X		N
DERBI	50	GPR NUDE 50	2004	2008	X		N	DUCATI	797	MONSTER 797	2017	2019	X		N
DERBI	50	SENDA HYP DRD EVO LIMITED ED.	2008	2008	X		N	DUCATI	797	MONSTER 797 PLUS	2017	2019	X		N
DERBI	50	SENDA R DRD RACING	2004	2008	X	X	N	DUCATI	800	SCRAMBLER SIKTY 2	2016	2020	X		N
DERBI	50	SENDA SM DRD RACING	2004	2008	X	X	N	DUCATI	800	SCRAMBLER CAFE RACER	2017	2019	X		N
DERBI	50	ATLANTIS 4T 50	2004	2007	X		N	DUCATI	800	SCRAMBLER CLASSIC	2015	2019	X		N
DERBI	50	ATLANTIS 4T EURO 2	2007	2007	X		N	DUCATI	800	SCRAMBLER DESERT SLEED	2017	2019	X		N
DERBI	50	GP1 RACE	2005	2007	X		N	DUCATI	800	SCRAMBLER FULL THROTTLE	2015	2019	X		N
DERBI	50	SENDA SM/R X-RACE	2005	2007	X		N	DUCATI	800	SCRAMBLER ICON	2015	2019	X		N
DERBI	50	SENDA SM/R X-TEAM	2005	2007	X		N	DUCATI	821	MONSTER 821 DARK	2015	2020	X		N
DERBI	50	ATLANTIS O2 CITY	2003	2006	X		N	DUCATI	821	MONSTER 821	2015	2019	X		N
DERBI	50	GPR NUDE 50 SPORT	2006	2006	X		N	DUCATI	821	MONSTER 821 STEALTH	2019	2019	X		N
DERBI	50	GP1 50	2005	2005	X		N	DUCATI	821	MONSTER 821 STRIPES	2015	2017	X		N
DERBI	50	SENDA SM DRD BLACK EDITION	2005	2005	X	X	N	DUCATI	848	STREETFIGHTER 848	2012	2013	X		N
DERBI	50	SENDA BLACK EDITION	2003	2003	X	X	N	DUCATI	900	MONSTER 900	1993	2001	X		N
DERBI	50	GP1 50	2001	2002	X		N	DUCATI	900	MONSTER 900 CITY	1999	1999	X		N
DERBI	50	PREDATOR H2O	1998	2001	X		N	DUCATI	900	MONSTER 900 CROMO	1998	1998	X		N
DERBI	50	PREDATOR O2	1998	2001	X		N	DUCATI	900	MONSTER 900 S	1998	1998	X		N
DERBI	50	SENDA R	1999	2000	X	X	N	DUCATI	916	MONSTER S4	2001	2001	X		N
DERBI	50	PADDOCK	1998	1999	X		N	DUCATI	1000	GT 1000	2007	2010	X		N
DERBI	50	HUNTER	1996	1997	X		N	DUCATI	1000	GT TOURING 1000	2009	2009	X		N
DERBI	50	VAMOS	1993	1995	X	X	N	DUCATI	1000	MULTISTRADA 1000	2003	2006	X		N
DERBI	100	BOULEVARD 4T 100	2010	2011	X	X	N	DUCATI	1000	MULTISTRADA DS 1000	2003	2006	X		N
DERBI	100	ATLANTIS 4T 100	2004	2007	X		N	DUCATI	1000	MULTISTRADA DS S 1000	2003	2006	X		N
DERBI	100	ATLANTIS 2T	2000	2001	X		N	DUCATI	1098	STREETFIGHTER S 1098	2009	2012	X		N
DERBI	125	SENDA DRD MOTARD	2013	2013	X		N	DUCATI	1098	STREETFIGHTER 1098	2009	2011	X		N
DERBI	125	CROSS CITY 4T	2007	2012	X		N	DUCATI	1100	SCRAMBLER 1100	2018	2019	X		N
DERBI	125	SENDA SM/R 4T BAJA	2006	2011	X		N	DUCATI	1100	SCRAMBLER 1100 SPECIAL	2018	2019	X		N
DERBI	125	MULHACÉN 4T	2007	2010	X		N	DUCATI	1100	SCRAMBLER 1100 SPORT	2018	2019	X		N
DERBI	125	RAMBLA 125	2008	2009	X		N	DUCATI	1100	MONSTER 20TH 1100	2013	2013	X		N
DERBI	125	SENDA DRD 4T-4V SM/R	2009	2009	X		N	DUCATI	1100	MONSTER EVO 1100	2011	2011	X		N

- BRAKE/CLUTCH MASTER CYLINDERS
- ACCESSORIES SPARE PARTS
- CNC-WORKED FLUID RESERVOIR
- FULL CLUTCH
- HYDRAULIC-CLUTCH TRANFORMATION KIT
- LEVER
- THROTTLE CONTROL
- BRAKE CALIPER
- RACING KIT
- BUTTON PANEL
- LEVER GUARD
- CLIP-ON
- STREET RACING REARSET
- FUEL CAPS
- STEERING NUT
- CRASH PADS
- PADDOCK STAND
- MIRROR COVERS
- REAR-VIEW MIRRORS
- FOG LIGHTS KIT
- HANDLEBARS ACCESSORIES
- HANDLEBARS

Marca Brand	CC	Modello Model	Dal From	Al To	MR002 / MR003	MR001	Novità New	Marca Brand	CC	Modello Model	Dal From	Al To	MR002 / MR003	MR001	Novità New
DUCATI	1100	MONSTER 1100	2008	2010	X		N	GILERA	250	NEXUS 250	2007	2008	X	X	N
DUCATI	1100	MONSTER 1100	2009	2010	X		N	GILERA	500	NEXUS 500	2006	2008	X	X	N
DUCATI	1100	MONSTER 1100 ABS	2010	2010	X		N	GILERA	500	FUOCO	2007	2007	X	X	N
DUCATI	1100	MONSTER 1100 S	2009	2010	X		N	HONDA	50	NSR	1998	1998	X	X	N
DUCATI	1100	MULTISTRADA 1100	2007	2009	X		N	HONDA	75	SH SCOOPY	1996	1996	X	X	N
DUCATI	1100	MULTISTRADA S 1100	2007	2009	X		N	HONDA	100	SCV LEAD	2003	2007	X		N
DUCATI	1200	MONSTER 1200	2014	2020	X		N	HONDA	100	SH T SCOOPY 100	1996	1996	X		N
DUCATI	1200	MONSTER 1200 S	2014	2020	X		N	HONDA	110	NHX LEAD I	2008	2008	X	X	N
DUCATI	1200	MONSTER 1200 R	2016	2019	X		N	HONDA	125	PCX	2011	2011	X	X	N
DUCATI	1200	DIAVEL CARBON FL	2015	2018	X		N	HONDA	125	FES PHANTEON 125	1998	2008	X		N
DUCATI	1200	DIAVEL FL	2015	2018	X		N	HONDA	125	SH SCOOPY I 125	2005	2008	X		N
DUCATI	1200	MONSTER 1200 S STRIPES	2015	2016	X		N	HONDA	125	ANF INNOVA	2003	2007	X	X	N
DUCATI	1200	DIAVEL STRADA	2013	2014	X		N	HONDA	125	XR 125 L	2007	2007	X	X	N
DUCATI	1200	DIAVEL WHITE STRIPE	2013	2014	X		N	HONDA	125	PS 125 PASSION I	2006	2006	X		N
DUCATI	1200	DIAVEL	2011	2013	X		N	HONDA	125	VARADERO	2006	2006	X	X	N
DUCATI	1200	DIAVEL AMG	2013	2013	X		N	HONDA	125	CHIOCHIOLA 125	2002	2005	X		N
DUCATI	1200	DIAVEL CARBON	2011	2013	X		N	HONDA	125	NES @ 125	2000	2005	X		N
DUCATI	1200	DIAVEL CROMO	2013	2013	X		N	HONDA	125	SH SCOOPY (1ª SERIE)	2001	2004	X		N
DUCATI	1260	DIAVEL 1260	2019	2020	X		N	HONDA	125	SES 125 DYLAN	2002	2002	X		N
DUCATI	1260	DIAVEL 1260 S	2019	2020	X		N	HONDA	150	FES PHANTEON 150	1998	2008	X		N
DUCATI	1262	X-DIAVEL	2016	2020	X		N	HONDA	150	SH SCOOPY I 150	2005	2008	X		N
DUCATI	1262	X-DIAVEL SPORT PACK B	2017	2018	X		N	HONDA	150	PS 150 PASSION I	2006	2006	X		N
GAS GAS	125	125 EC	2002	2011	X	X	N	HONDA	150	CHIOCHIOLA 150	2002	2005	X		N
GAS GAS	125	125 TXT RAGA	2009	2011	X	X	N	HONDA	150	NES @ 150	2000	2005	X		N
GAS GAS	125	125 TXT PRO	2004	2010	X	X	N	HONDA	150	SH (1ª SERIE)	2001	2004	X		N
GAS GAS	200	200 EC	2002	2011	X	X	N	HONDA	150	SES 150 DYLAN	2002	2002	X		N
GAS GAS	200	200 TXT PRO	2004	2010	X	X	N	HONDA	250	FES FORESIGHT (1ª SERIE)	1998	2000	X	X	N
GAS GAS	250	250 EC	2002	2011	X	X	N	HONDA	600	SW-T GT ABS	2011	2011	X	X	N
GAS GAS	250	250 TXT RAGA	2009	2011	X	X	N	HONDA	600	CBR 600 F	2007	2010	X	X	N
GAS GAS	250	250 TXT PRO	2004	2010	X	X	N	HONDA	600	CB 600 HORNET	2006	2007	X	X	N
GAS GAS	280	280 TXT RAGA	2009	2011	X	X	N	HONDA	600	VT 600 SHADOW C	1999	1999	X	X	N
GAS GAS	280	280 TXT PRO	2004	2010	X	X	N	HONDA	600	VT 600 SHADOW S	1999	1999	X	X	N
GAS GAS	300	300 EC	2002	2011	X	X	N	HONDA	600	XL 600 V TRANSALP	1993	1994	X	X	N
GAS GAS	300	300 TXT PRO	2004	2010	X	X	N	HONDA	650	CB 650 F	2014	2019	X		N
GILERA	50	STALKER	1997	2009	X	X	N	HONDA	650	TRANSALP TRAVEL	2007	2007	X	X	N
GILERA	50	STALKER NAKED	2008	2008	X	X	N	HONDA	650	XL 650 V TRANSALP	1993	1994	X	X	N
GILERA	50	STALKER SPECIAL EDITION	2007	2008	X	X	N	HONDA	650	NX DOMINATOR	1992	1993	X	X	N
GILERA	50	DNA 50	2000	2007	X	X	N	HONDA	700	NC 700X	2012	2017	X		N
GILERA	50	RUNNER PUREJET	2002	2007	X	X	N	HONDA	700	INTEGRA 700	2012	2013	X		N
GILERA	50	RUNNER SP	2002	2007	X	X	N	HONDA	750	INTEGRA 750	2014	2019	X		N
GILERA	50	RUNNER SP SPECIAL EDITION	2007	2007	X	X	N	HONDA	750	INTEGRA 750 S	2014	2019	X		N
GILERA	50	STORM EURO2	2007	2007	X	X	N	HONDA	750	NC 750 S	2014	2019	X		N
GILERA	50	DNA GP EXPERINCE	2003	2004	X	X	N	HONDA	750	NC 750 X	2014	2019	X		N
GILERA	50	RUNNER	1997	2002	X	X	N	HONDA	750	VT 750 S	2010	2010	X	X	N
GILERA	50	RUNNER POGGIALI	2002	2002	X	X	N	HONDA	750	SHADOW	2007	2007	X	X	N
GILERA	50	ZULÚ	2001	2001	X	X	N	HONDA	750	SHADOW SPIRIT	2007	2007	X	X	N
GILERA	50	RK CANNIBAL	1996	1998	X	X	N	HONDA	750	VT 750 C2	1998	1998	X	X	N
GILERA	125	NEXUS 125	2007	2008	X	X	N	HONDA	750	VT C	1998	1998	X	X	N
GILERA	125	DNA 125	2000	2007	X	X	N	HONDA	750	XRV 750 AFRICA TWIN	1993	1993	X	X	N
GILERA	125	RUNNER VX 4T EURO3	2007	2007	X	X	N	HONDA	800	CROSSRUNNER	2011	2011	X	X	N
GILERA	125	RUNNER VX RACE	2006	2007	X	X	N	HONDA	1000	CRF 1000 L AFRICA TWIN	2016	2019	X		N
GILERA	125	RUNNER VX SC	2006	2007	X	X	N	HONDA	1000	CRF 1000 L AFRICA TWIN ADVENTURE SPORT	2018	2019	X		N
GILERA	125	RUNNER VX	2000	2006	X	X	N	HONDA	1000	CB 1000 R	2008	2016	X		N
GILERA	125	RUNNER FX	1997	2002	X	X	N	HONDA	1000	CB 1000 R	2008	2008	X	X	N
GILERA	180	DNA 180	2000	2007	X	X	N	HONDA	1100	VT 1100 C2	1998	1998	X	X	N
GILERA	180	RUNNER FXR	1997	2002	X	X	N	HONDA	1100	VT 1100 C3	1998	1998	X	X	N
GILERA	180	RUNNER VXR 180	2000	2001	X	X	N	HONDA	1200	CROSSTOURER X	2012	2012	X	X	N
GILERA	200	RUNNER VXR 200	2002	2007	X	X	N	HONDA	1300	VT 1300 CX	2009	2009	X		N

BRAKE/CLUTCH
 MASTER CYLINDERS
 ACCESSORIES
 SPARE PARTS
 CNC-WORKED FLUID
 RESERVOIR
 FULL CLUTCH
 HYDRAULIC-CLUTCH
 TRANFORMATION KIT
 LEVER
 THROTTLE CONTROL
 BRAKE CALIPER
 RACING KIT
 BUTTON PANEL
 LEVER GUARD
 CLIP-ON
 STREET RACING
 REARSET
 FUEL CAPS
 STEERING NUT
 CRASH PADS
 PADDOCK STAND
 MIRROR COVERS
 REAR-VIEW MIRRORS
 FOG LIGHTS KIT
 HANDLEBARS
 ACCESSORIES
 HANDLEBARS

Marca Brand	CC	Modello Model	Dal From	Al To	MR002 / MR003	MR001	Novità New	Marca Brand	CC	Modello Model	Dal From	Al To	MR002 / MR003	MR001	Novità New
HONDA	1800	VALKYRIE NRX RUNE	2004	2004	X		N	KEEWAY	50	RY8	2008	2008	X		N
HYOSUNG	50	SB M SUPER CAB	2008	2008	X	X	N	KEEWAY	50	FOCUS 50	2006	2006	X		N
HYOSUNG	50	SD SENSE	2000	2005	X	X	N	KEEWAY	125	FOCUS 125	2006	2006	X		N
HYOSUNG	50	SF B	2005	2005	X	X	N	KEEWAY	150	FOCUS 150	2006	2006	X		N
HYOSUNG	50	SF R	2005	2005	X	X	N	KTM	125	DUKE 125	2011	2019	X		N
HYOSUNG	100	EZ M	2007	2008	X	X	N	KTM	200	DUKE 200	2012	2015	X		N
HYOSUNG	125	GV125 AQUILA	2005	2008	X	X	N	KTM	690	DUKE 690	2009	2019	X		N
HYOSUNG	250	GV250 AQUILA	2004	2007	X	X	N	KTM	690	DUKE 690 R	2013	2017	X		N
HYOSUNG	650	GV650FI AQUILA	2007	2008	X	X	N	KTM	790	DUKE 790	2018	2019	X		N
HYOSUNG	700	ST7	2010	2010	X	X	N	KTM	790	DUKE 790 L	2018	2019	X		N
HYOSUNG	700	GV700C AQUILA	2009	2009	X	X	N	KTM	950	SUPERMOTO 950	2005	2006	X	X	N
HYOSUNG	700	GV700C AQUILA DELUXE	2009	2009	X	X	N	KTM	990	SUPERDUKE 990	2006	2006	X	X	N
KAWASAKI	125	KLX 125	2010	2016	X	X	N	KYMCO	50	LIKE 2T	2009	2009	X	X	N
KAWASAKI	125	KLX D-TRACKER 125	2010	2014	X	X	N	KYMCO	50	LIKE 4T	2009	2009	X	X	N
KAWASAKI	125	BN125 ELIMINATOR	2000	2007	X	X	N	KYMCO	50	AGILITY 4T R16	2008	2008	X	X	N
KAWASAKI	150	KLX D-TRACKER 150	2016	2016	X	X	N	KYMCO	50	AGILITY R10	2005	2008	X	X	N
KAWASAKI	150	KLX 150	2014	2014	X	X	N	KYMCO	50	AGILITY R12	2005	2008	X	X	N
KAWASAKI	230	KLX 230	2020	2020	X	X	N	KYMCO	50	MXU 50	2003	2008	X	X	N
KAWASAKI	250	KLX 250	2009	2017	X	X	N	KYMCO	50	PEOPLE S 4T	2006	2008	X	X	N
KAWASAKI	250	ELIMINATOR F2	1996	1998	X	X	N	KYMCO	50	PEOPLE S 50	2005	2008	X	X	N
KAWASAKI	300	Z 300	2015	2018	X	X		KYMCO	50	DINK 4T	2007	2007	X	X	N
KAWASAKI	500	ER-5	1997	2005	X	X	N	KYMCO	50	DINK YAGER GT	2007	2007	X	X	N
KAWASAKI	500	EN 500	1992	2003	X	X	N	KYMCO	50	SUPER 84T	2007	2007	X	X	N
KAWASAKI	600	ELIMINATOR	1995	1997	X	X	N	KYMCO	50	MAXXER	2005	2005	X	X	N
KAWASAKI	600	ZL 600 ELIMINATOR	1995	1997	X	X	N	KYMCO	50	FEVER ZX	1999	2004	X	X	N
KAWASAKI	650	ER-6N	2012	2016	X	X		KYMCO	50	MXER 50	2002	2004	X	X	N
KAWASAKI	650	KLE VERSYS / ABS	2007	2009	X	X	N	KYMCO	50	SUPER 9 SPORT	2003	2004	X	X	N
KAWASAKI	650	ER-6N / ABS	2007	2008	X	X	N	KYMCO	50	VITALITY 2T	2004	2004	X	X	N
KAWASAKI	650	KLR 650	1995	2004	X	X	N	KYMCO	50	VITALITY 4T	2004	2004	X	X	N
KAWASAKI	650	EJ W650 ESTRELLA	1999	2000	X	X	N	KYMCO	50	YUP	2002	2003	X	X	N
KAWASAKI	650	KLX	1993	1999	X	X	N	KYMCO	50	B & W 50	2000	2002	X	X	N
KAWASAKI	750	Z 750 R / R ABS	2011	2012	X	X	N	KYMCO	50	FILLY LX	2001	2002	X	X	N
KAWASAKI	750	Z 750 / ABS	2007	2010	X	X	N	KYMCO	50	FILLY	1998	2000	X	X	N
KAWASAKI	750	ZR-7	1999	2003	X	X	N	KYMCO	50	K12	1995	2000	X	X	N
KAWASAKI	750	ZR 750 ZEPHYR	1991	1995	X	X	N	KYMCO	50	KB 50	1995	2000	X	X	N
KAWASAKI	800	Z 800 / Z 800 E	2013	2016	X		N	KYMCO	50	SUPER 9	2000	2000	X	X	N
KAWASAKI	800	W 800	2011	2012	X	X	N	KYMCO	50	TOP BOY	1997	2000	X	X	N
KAWASAKI	800	VN800 CLASSIC	2000	2006	X	X	N	KYMCO	50	DJ X	1991	1993	X	X	N
KAWASAKI	800	VN800 DRIFTER	1999	2001	X	X	N	KYMCO	50	DJ Y	1991	1993	X	X	N
KAWASAKI	900	Z 900	2017	2019	X		N	KYMCO	100	KB 100	1995	2000	X	X	N
KAWASAKI	900	Z 900 RS	2018	2019	X		N	KYMCO	125	G-DINK 125	2012	2012	X	X	N
KAWASAKI	900	Z 900 RS CAFE	2018	2019	X		N	KYMCO	125	K-XCT 125 I	2012	2012	X	X	N
KAWASAKI	900	VN900 CUSTOM	2007	2015	X	X	N	KYMCO	125	PEOPLE GTI 125	2010	2010	X	X	N
KAWASAKI	1000	VERSYS 1000 ABS	2012	2014	X	X		KYMCO	125	QUANNON NAKED	2010	2010	X	X	N
KAWASAKI	1000	Z 1000 / ABS	2007	2009	X	X	N	KYMCO	125	DOWNTOWN 125 I	2009	2009	X	X	N
KAWASAKI	1000	KLV 1000	2004	2005	X	X	N	KYMCO	125	G5 125 I	2009	2009	X	X	N
KAWASAKI	1100	ZR 1100 ZEPHYR	1991	1995	X	X	N	KYMCO	125	LIKE 125	2009	2009	X	X	N
KAWASAKI	1500	VN1500 CLASSIC	2000	2003	X	X	N	KYMCO	125	LIKE 125 LX	2009	2009	X	X	N
KAWASAKI	1500	VN1500 CLASSIC TOURER	2000	2003	X	X	N	KYMCO	125	NIKITA I 125	2009	2009	X	X	N
KAWASAKI	1500	VN1500 DRIFTER	1999	2000	X	X	N	KYMCO	125	SUPER DINK I 125	2009	2009	X	X	N
KAWASAKI	1600	VN 1600 CLASSIC	2003	2006	X	X	N	KYMCO	125	AGILITY 4T	2006	2008	X	X	N
KAWASAKI	1600	VN 1600 CLASSIC TOURER	2005	2006	X	X	N	KYMCO	125	PEOPLE S DD	2007	2008	X	X	N
KAWASAKI	1700	VN 1700 CLASSIC	2009	2014	X	X	N	KYMCO	125	SUPER 8	2008	2008	X	X	N
KAWASAKI	1700	VN 1700 CLASSIC TOURER	2009	2014	X	X	N	KYMCO	125	DINK 125	2006	2007	X	X	N
KAWASAKI	1700	VN 1700 VOYAGER	2009	2012	X	X	N	KYMCO	125	MOVIE 125	1999	2007	X	X	N
KAWASAKI	2000	VN 2000 CLASSIC	2008	2010	X	X	N	KYMCO	125	PEOPLE S 125	2005	2005	X	X	N
KAWASAKI	2000	VN 2000	2004	2006	X	X	N	KYMCO	125	B&W 125	2000	2004	X	X	N
KEEWAY	50	RY6	2010	2010	X		N	KYMCO	125	MOVIE XL 125	2001	2004	X	X	N

BRAKE/CLUTCH
 MASTER CYLINDERS
 ACCESSORIES
 SPARE PARTS
 CNC-WORKED FLUID
 RESERVOIR
 FULL CLUTCH
 HYDRAULIC-CLUTCH
 TRANFORMATION KIT
 LEVER
 THROTTLE CONTROL
 BRAKE CALIPER
 RACING KIT
 BUTTON PANEL
 LEVER GUARD
 CLIP-ON
 STREET RACING
 REARSET
 FUEL CAPS
 STEERING NUT
 CRASH PADS
 PADDOCK STAND
 MIRROR COVERS
 REAR-VIEW MIRRORS
 FOG LIGHTS KIT
 HANDLEBARS
 ACCESSORIES
 HANDLEBARS

Marca Brand	CC	Modello Model	Dal From	Al To	MR002 / MR003	MR001	Novità New	Marca Brand	CC	Modello Model	Dal From	Al To	MR002 / MR003	MR001	Novità New
KYMCO	125	MXER 125	2002	2004	X	X	N	MBK	50	EW STUNT	2000	2004	X		N
KYMCO	125	VIVIO 125	2000	2000	X	X	N	MBK	50	YH FLIPPER	2001	2004	X		N
KYMCO	150	LIKE 150	2009	2009	X	X	N	MBK	50	CW BOOSTER 50	2003	2003	X		N
KYMCO	150	MXU 150	2003	2008	X	X	N	MBK	50	CW BOOSTER NAKED	2003	2003	X		N
KYMCO	150	MOVIE 150	2006	2007	X	X	N	MBK	50	CW BOOSTER NAKED 12"	2003	2003	X		N
KYMCO	150	MOVIE XL 150	2006	2007	X	X	N	MBK	50	CW BOOSTER NG	2003	2003	X		N
KYMCO	150	B&W 150	2000	2004	X	X	N	MBK	50	CW L BOOSTER SPIRIT	2003	2003	X		N
KYMCO	150	MOVIE XL 150	2001	2004	X	X	N	MBK	50	CS MACH G AC	2002	2002	X		N
KYMCO	150	MXER 150	2002	2004	X	X	N	MBK	50	CS MACH G LC	2002	2002	X		N
KYMCO	150	VIVIO 150	2000	2000	X	X	N	MBK	50	CW RS BOOSTER	2001	2002	X		N
KYMCO	200	DOWNTOWN 200	2010	2010	X	X	N	MBK	50	BOOSTER	2001	2001	X		N
KYMCO	200	SUPERDINK	2010	2010	X	X	N	MBK	50	BOOSTER R	2001	2001	X		N
KYMCO	200	LIKE 200	2009	2009	X	X	N	MBK	50	YQ NITRO JAGUAR 50	2001	2001	X		N
KYMCO	200	LIKE 200 LX	2009	2009	X	X	N	MBK	50	YN OVETTO	2000	2000	X		N
KYMCO	200	DINK 200 I	2006	2007	X	X	N	MBK	50	YQ NITRO 50	2000	2000	X		N
KYMCO	200	PEOPLE S I	2007	2007	X	X	N	MBK	100	CW BOOSTER 100	1999	2001	X		N
KYMCO	200	PEOPLE S 200	2005	2005	X	X	N	MBK	100	YN OVETTO 100	2000	2000	X		N
KYMCO	250	MXU 250	2003	2008	X	X	N	MBK	100	YQ NITRO 100	2000	2000	X		N
KYMCO	250	PEOPLE S 250	2006	2006	X	X	N	MBK	125	X.OVER 4T	2010	2010	X		N
KYMCO	250	B & W 250	2000	2004	X	X	N	MBK	125	SKY CRUISER 125	2007	2009	X		N
KYMCO	300	G-DINK 300	2012	2012	X	X	N	MBK	125	XC FLAME X 125	2006	2006	X		N
KYMCO	300	K-XCT 300 I	2012	2012	X	X	N	MBK	125	XC FLAME F 125	2000	2005	X		N
KYMCO	300	PEOPLE GTI 300	2010	2010	X	X	N	MBK	125	YP E SKYLINER 125	2003	2003	X		N
KYMCO	300	DOWNTOWN 300 I	2009	2009	X	X	N	MBK	125	XQ THUNDER 125	2001	2002	X		N
KYMCO	300	NIKITA I 300	2009	2009	X	X	N	MBK	125	YP SKYLINER 125	1998	2002	X		N
KYMCO	300	SUPER DINK I 300	2009	2009	X	X	N	MBK	125	XC K FLAME R 125	1996	1999	X		N
KYMCO	300	MXU 300	2003	2008	X	X	N	MBK	125	XC T FLAME 125	1995	1999	X		N
KYMCO	400	MXU 400	2003	2008	X	X	N	MBK	150	XC FLAME X 150	2006	2006	X		N
KYMCO	500	MXU 500	2003	2008	X	X	N	MBK	150	XC FLAME F 150	2000	2005	X		N
LML	200	LML STAR 4T 200	2011	2011	X	X	N	MBK	150	XQ THUNDER 150	2001	2002	X		N
MALAGUTI	50	F10	1992	2010	X		N	MBK	150	YP SKYLINER 150	1998	2002	X		N
MALAGUTI	50	F12R PHANTOM AC	2009	2009	X		N	MBK	150	XC K FLAME R 150	1996	1999	X		N
MALAGUTI	50	CENTRO 4T	2008	2008	X		N	MBK	150	XC T FLAME 150	1995	1999	X		N
MALAGUTI	50	F12R PHANTOM AC	1997	2008	X		N	MBK	180	YP SKYLINER 180	1998	2002	X		N
MALAGUTI	50	F12R PHANTOM LC	2007	2007	X		N	MBK	250	SKY CRUISER 250	2007	2009	X		N
MALAGUTI	50	CIAK 50	1999	2006	X		N	MBK	250	YP SKYLINER 250	1998	2003	X		N
MALAGUTI	50	F12 PHANTOM AC	1994	2006	X		N	MBK	250	YP SKYLINER ABS 250	1998	2003	X		N
MALAGUTI	50	F12 PHANTOM LC	1994	2006	X		N	MBK	250	YP SKYLINER DX 250	1998	2003	X		N
MALAGUTI	50	CNK DRAGON	2005	2005	X		N	MOTO GUZZI	350	350 NEVADA CLUB	1998	1999	X	X	N
MALAGUTI	50	CENTRO	1993	2000	X		N	MOTO GUZZI	350	350 NEVADA NUOVO TIPO	1993	1997	X	X	N
MALAGUTI	50	YESTERDAY	1997	2000	X		N	MOTO GUZZI	350	350 NEVADA VECCHIO TIPO	1991	1993	X	X	N
MALAGUTI	50	CROSSER CR1	1995	1998	X		N	MOTO GUZZI	350	V35 FLORIDA	1986	1990	X	X	N
MALAGUTI	100	CIAK 100	1999	2006	X		N	MOTO GUZZI	350	V35C	1982	1986	X	X	N
MALAGUTI	125	BLOG IE 125	2009	2009	X		N	MOTO GUZZI	500	V50C	1982	1986	X	X	N
MALAGUTI	125	CENTRO IE 125	2008	2008	X		N	MOTO GUZZI	500	V50 III	1980	1984	X	X	N
MALAGUTI	125	CIAK 125	1999	2006	X		N	MOTO GUZZI	650	650 V65 FLORIDA	1985	1992	X	X	N
MALAGUTI	125	F18 WARRIOR 125	2000	2002	X		N	MOTO GUZZI	650	V65 FLORIDA	1985	1992	X	X	N
MALAGUTI	150	F18 WARRIOR 150	2000	2002	X		N	MOTO GUZZI	650	V65 GT	1988	1989	X	X	N
MALAGUTI	160	BLOG IE 160	2009	2009	X		N	MOTO GUZZI	650	V65 CUSTOM	1983	1986	X	X	N
MALAGUTI	160	CENTRO IE 160	2009	2009	X		N	MOTO GUZZI	750	750 V7 II SPECIAL ABS	2015	2016	X	X	N
MALAGUTI	160	CENTRO SL IE 160	2009	2009	X		N	MOTO GUZZI	750	750 V7 SPECIAL	2012	2014	X	X	N
MALAGUTI	200	CIAK 200	1999	2006	X		N	MOTO GUZZI	750	750 NEVADA CLASSIC	2004	2013	X	X	N
MALAGUTI	250	PASSWORD EURO3	2007	2007	X		N	MOTO GUZZI	750	750 V7 RACER	2010	2013	X	X	N
MALAGUTI	250	PASSWORD	2005	2006	X		N	MOTO GUZZI	750	750 NEVADA S ANNIVERSARIO	2012	2012	X	X	N
MALAGUTI	-	CIAK ELETTRICO	2000	2001	X		N	MOTO GUZZI	750	750 V7 CLASSIC	2008	2012	X	X	N
MBK	50	YN OVETTO 4	2009	2009	X		N	MOTO GUZZI	750	750 NEVADA S	2010	2010	X	X	N
MBK	50	YQ NITRO 50	2009	2009	X		N	MOTO GUZZI	750	750 BREVA	2003	2009	X	X	N
MBK	50	YQ NITRO NAKED 50	2009	2009	X		N	MOTO GUZZI	750	750 V7 CAFE CLASSIC	2009	2009	X	X	N

BRAKE/CLUTCH
 MASTER CYLINDERS
 ACCESSORIES
 SPARE PARTS
 CNC-WORKED FLUID
 RESERVOIR
 FULL CLUTCH
 HYDRAULIC-CLUTCH
 TRANFORMATION KIT
 LEVER
 THROTTLE CONTROL
 BRAKE CALIPER
 RACING KIT
 BUTTON PANEL
 LEVER GUARD
 CLIP-ON
 STREET RACING
 REARSET
 FUEL CAPS
 STEERING NUT
 CRASH PADS
 PADDOCK STAND
 MIRROR COVERS
 REAR-VIEW MIRRORS
 FOG LIGHTS KIT
 HANDLEBARS
 ACCESSORIES
 HANDLEBARS

Marca Brand	CC	Modello Model	Dal From	Al To	MR002 / MR003	MR001	Novità New	Marca Brand	CC	Modello Model	Dal From	Al To	MR002 / MR003	MR001	Novità New
MOTO GUZZI	750	750 NEVADA	2002	2003	X	X	N	PEUGEOT	50	JET C-TECH ICE BLADE	2009	2009	X	X	N
MOTO GUZZI	750	750 X POLIZIA	1995	2002	X	X	N	PEUGEOT	50	JET FORCE H2I	2009	2009	X	X	N
MOTO GUZZI	750	750 NEVADA CLUB	1998	2001	X	X	N	PEUGEOT	50	LUDIX BLASTER ICE BLADE	2009	2009	X	X	N
MOTO GUZZI	750	750 NEVADA NUOVO TIPO	1993	1997	X	X	N	PEUGEOT	50	LUDIX ONE BIPLAZA	2009	2009	X	X	N
MOTO GUZZI	750	750 NEVADA VECCHIO TIPO	1991	1993	X	X	N	PEUGEOT	50	VIVACITY 4T 50	2009	2009	X	X	N
MOTO GUZZI	850	V9 ROAMER	2016	2018	X	X	N	PEUGEOT	50	JET C-TECH LC	2008	2008	X	X	N
MOTO GUZZI	850	850 BREVA	2005	2008	X	X	N	PEUGEOT	50	SPEEDFIGHT 2 AC	2007	2008	X	X	N
MOTO GUZZI	850	850 NORGE	2006	2008	X	X	N	PEUGEOT	50	SPEEDFIGHT 2 LC	2007	2008	X	X	N
MOTO GUZZI	850	850 GRISO	2006	2007	X	X	N	PEUGEOT	50	V-CLIC 4T	2008	2008	X	X	N
MOTO GUZZI	940	BELLAGIO / AQUILA NERA	2007	2013	X	X	N	PEUGEOT	50	VIVACITY 2T	2008	2008	X	X	N
MOTO GUZZI	1000	1000 V10 CENTAURO	1997	1999	X	X	N	PEUGEOT	50	VIVACITY SPORTLINE	2005	2005	X	X	N
MOTO GUZZI	1000	1000 S	1989	1994	X	X	N	PEUGEOT	50	JET FORCE	2003	2003	X	X	N
MOTO GUZZI	1000	1000 S	1989	1994	X	X	N	PEUGEOT	50	TREKKER 50	2000	2000	X	X	N
MOTO GUZZI	1000	1000 CALIFORNIA III CARB.	1990	1993	X	X	N	PEUGEOT	50	VIVACITY 50	2000	2000	X	X	N
MOTO GUZZI	1000	1000 CALIFORNIA III INYCC.	1990	1993	X	X	N	PEUGEOT	50	SPEEDFIGHT 50	1998	1998	X	X	N
MOTO GUZZI	1000	LE MANS	1984	1993	X	X	N	PEUGEOT	50	FOX	1995	1995	X	X	N
MOTO GUZZI	1000	1000 GT	1987	1991	X	X	N	PEUGEOT	50	SV 50	1995	1995	X	X	N
MOTO GUZZI	1000	CALIFORNIA II	1981	1987	X	X	N	PEUGEOT	100	TREKKER 100	2000	2000	X	X	N
MOTO GUZZI	1100	1100 CALIFORNIA AQUILA NERA	2009	2011	X	X	N	PEUGEOT	100	VIVACITY 100	2000	2000	X	X	N
MOTO GUZZI	1100	1100 BREVA	2005	2008	X	X	N	PEUGEOT	100	SPEEDFIGHT 100	1998	1998	X	X	N
MOTO GUZZI	1100	1100 CALIFORNIA TOURING	2003	2008	X	X	N	PEUGEOT	125	SATELIS 125	2006	2012	X	X	N
MOTO GUZZI	1100	1100 GRISO	2005	2008	X	X	N	PEUGEOT	125	SATELIS RS 125	2008	2012	X	X	N
MOTO GUZZI	1100	1100 CALIFORNIA EV	1997	2005	X	X	N	PEUGEOT	125	CITYSTAR I 4T-4V 125	2011	2011	X	X	N
MOTO GUZZI	1100	1100 CALIFORNIA STONE	2001	2005	X	X	N	PEUGEOT	125	SATELIS 4T-4V	2010	2011	X	X	N
MOTO GUZZI	1100	1100 V11 BALLABIO	2003	2005	X	X	N	PEUGEOT	125	SATELIS COMPRESSOR	2006	2011	X	X	N
MOTO GUZZI	1100	1100 V11 CAFÉ SPORT	2003	2005	X	X	N	PEUGEOT	125	SATELIS GT SPORT	2010	2011	X	X	N
MOTO GUZZI	1100	1100 V11 COPPA ITALIA	2003	2005	X	X	N	PEUGEOT	125	SATELIS WHITESHAT K	2010	2010	X	X	N
MOTO GUZZI	1100	1100 V11 LE MANS NAKED	2001	2005	X	X	N	PEUGEOT	125	TWEET 125	2010	2010	X	X	N
MOTO GUZZI	1100	1100 V11 SPORT	2009	2005	X	X	N	PEUGEOT	125	VIVACITY 4T 125	2010	2010	X	X	N
MOTO GUZZI	1100	1100 CALIFORNIA STONE METAL	2002	2003	X	X	N	PEUGEOT	125	LXR 125	2009	2009	X	X	N
MOTO GUZZI	1100	1100 CALIFORNIA	1994	2002	X	X	N	PEUGEOT	125	GEO RS 4T-4V	2008	2008	X	X	N
MOTO GUZZI	1100	1100 CALIFORNIA SPORT	2001	2002	X	X	N	PEUGEOT	125	GEOPLIS 125	2008	2008	X	X	N
MOTO GUZZI	1100	1100 CALIFORNIA JACKAL	1999	2001	X	X	N	PEUGEOT	125	SATELIS BLACKSAT K	2008	2008	X	X	N
MOTO GUZZI	1100	1100 QUOTA	1992	2001	X	X	N	PEUGEOT	150	TWEET 150	2010	2010	X	X	N
MOTO GUZZI	1100	1100 QUOTA ES	1999	2001	X	X	N	PEUGEOT	150	LXR 150	2009	2009	X	X	N
MOTO GUZZI	1100	1100 CALIFORNIA SPECIAL	1999	2000	X	X	N	PEUGEOT	200	CITYSTAR I 4T-4V 200	2011	2011	X	X	N
MOTO GUZZI	1200	1200 STELVIO	2008	2017	X	X	N	PEUGEOT	200	LXR 200	2009	2009	X	X	N
MOTO GUZZI	1200	1200 GRISO SE 8V	2015	2016	X	X	N	PEUGEOT	250	GEO RS	2008	2008	X	X	N
MOTO GUZZI	1200	1200 GRISO 8V	2008	2013	X	X	N	PEUGEOT	250	GEOPLIS 250	2008	2008	X	X	N
MOTO GUZZI	1200	1200 SPORT 8V	2008	2013	X	X	N	PEUGEOT	250	GEOPLIS 250 ABS	2008	2008	X	X	N
MOTO GUZZI	1200	1200 BREVA	2005	2008	X	X	N	PEUGEOT	250	SATELIS RS 250	2008	2008	X	X	N
MOTO GUZZI	1200	1200 NORGE	2006	2008	X	X	N	PEUGEOT	250	SATELIS 250	2006	2006	X	X	N
MOTO GUZZI	1200	1200 SPORT	2006	2007	X	X	N	PEUGEOT	300	GEOSTYLE	2010	2010	X	X	N
MOTO GUZZI	1400	1400 CALIFORNIA TOURING ABS	2013	2017	X	X	N	PEUGEOT	400	METROPOLIS 400I	2012	2012	X	X	N
MOTO GUZZI	1400	1400 CALIFORNIA CORAZZIERI	2016	2016	X	X	N	PEUGEOT	400	GEOPLIS 400	2008	2008	X	X	N
MV AGUSTA	675	BRUTALE 675	2012	2019	X	X		PEUGEOT	400	SATELIS RS 400	2008	2008	X	X	N
MV AGUSTA	800	BRUTALE 800 / RR / DRAGSTER / PIRELLI / AMERICA / RC	2012	2019	X	X		PEUGEOT	400	SATELIS 400	2006	2006	X	X	N
MV AGUSTA	800	STRADALE	2015	2015	X	X	N	PEUGEOT	500	SATELIS RS 500	2008	2008	X	X	N
MV AGUSTA	920	BRUTALE 920	2011	2011	X	X	N	PEUGEOT	500	SATELIS 500	2006	2006	X	X	N
MV AGUSTA	990	BRUTALE 990 R	2010	2011	X	X	N	PGO	50	BIG MAX	2006	2006	X		N
MV AGUSTA	1090	BRUTALE 1090 / R / RR / CORSA	2013	2015	X	X		PGO	150	DR BIG	2008	2008	X		N
PEUGEOT	10	E-VIVACITY	2010	2010	X	X	N	PIAGGIO	50	APE (BRAZO LENGTH)	1982	2005	X	X	N
PEUGEOT	50	BLASTER FURIOUS 2T	2010	2010	X	X	N	PIAGGIO	50	APE (BRAZO CORTO)	1987	2004	X	X	N
PEUGEOT	50	KISBEE 4T	2010	2010	X	X	N	PIAGGIO	50	FLY 2T	2005	2011	X	X	N
PEUGEOT	50	KISBEE RS 4T	2010	2010	X	X	N	PIAGGIO	50	FLY 4T 50	2006	2011	X	X	N
PEUGEOT	50	TWEET 50	2010	2010	X	X	N	PIAGGIO	50	TYPHOON 2T	2011	2011	X	X	N
PEUGEOT	50	VIVACITI SPORTLINE 2T	2010	2010	X	X	N	PIAGGIO	50	VESPA S 2T COLLEGE 50	2010	2010	X	X	N
PEUGEOT	50	C-TECH DARK SIDE	2009		X	X	N	PIAGGIO	50	TYPHOON	2005	2009	X	X	N

BRAKE/CLUTCH
 MASTER CYLINDERS
 ACCESSORIES
 SPARE PARTS
 CNC-WORKED FLUID
 RESERVOIR
 FULL CLUTCH
 HYDRAULIC-CLUTCH
 TRANFORMATION KIT
 LEVER
 THROTTLE CONTROL
 BRAKE CALIPER
 RACING KIT
 BUTTON PANEL
 LEVER GUARD
 CLIP-ON
 STREET RACING
 REARSET
 FUEL CAPS
 STEERING NUT
 CRASH PADS
 PADDOCK STAND
 MIRROR COVERS
 REAR-VIEW MIRRORS
 FOG LIGHTS KIT
 HANDLEBARS
 ACCESSORIES
 HANDLEBARS

Marca Brand	CC	Modello Model	Dal From	Al To	MR002 / MR003	MR001	Novità New	Marca Brand	CC	Modello Model	Dal From	Al To	MR002 / MR003	MR001	Novità New
PIAGGIO	50	VESPA LX 2T FL 50	2009	2009	X	X	N	PIAGGIO	125	VESPA LXV 125	2006	2009	X	X	N
PIAGGIO	50	VESPA LX 4T FL 50	2009	2009	X	X	N	PIAGGIO	125	VESPA S IE 4T 125	2009	2009	X	X	N
PIAGGIO	50	VESPA LXV 50	2006	2009	X	X	N	PIAGGIO	125	LIBERTY 125	2007	2008	X	X	N
PIAGGIO	50	LIBERTY 2T 50	1997	2008	X	X	N	PIAGGIO	125	LIBERTY CORREOS CTT 125	2008	2008	X	X	N
PIAGGIO	50	LIBERTY 4T 50	2005	2008	X	X	N	PIAGGIO	125	MP3 125	2006	2008	X	X	N
PIAGGIO	50	LIBERTY CORREOS CTT 50	2008	2008	X	X	N	PIAGGIO	125	MP3 IE	2008	2008	X	X	N
PIAGGIO	50	NRG POWER DD	2005	2008	X	X	N	PIAGGIO	125	VESPA GTS SUPER IE 125	2008	2008	X	X	N
PIAGGIO	50	NRG POWER DD SERIE SPECIALE	2007	2008	X	X	N	PIAGGIO	125	VESPA LX 125	2005	2008	X	X	N
PIAGGIO	50	NRG POWER DT	2005	2008	X	X	N	PIAGGIO	125	VESPA S 4T 125	2007	2008	X	X	N
PIAGGIO	50	NRG POWER DT SERIE SPECIALE	2007	2008	X	X	N	PIAGGIO	125	BEVERLY RST 125	2004	2007	X	X	N
PIAGGIO	50	NRG PUREJET	2002	2008	X	X	N	PIAGGIO	125	CARNABY 125	2007	2007	X	X	N
PIAGGIO	50	VESPA LX 2T 50	2005	2008	X	X	N	PIAGGIO	125	VESPA GRAN TURISMO 125	2003	2007	X	X	N
PIAGGIO	50	VESPA LX 4T 50	2005	2008	X	X	N	PIAGGIO	125	VESPA PX "30 ANIVERSARIO"	2007	2007	X	X	N
PIAGGIO	50	VESPA S 4T-4V 50	2008	2008	X	X	N	PIAGGIO	125	LIBERTY SPORT 4T 125	2006	2006	X	X	N
PIAGGIO	50	FLY 4T (MOTOR CHINA)	2006	2007	X	X	N	PIAGGIO	125	FLY 125	2005	2005	X	X	N
PIAGGIO	50	VESPA S 2T 50	2007	2007	X	X	N	PIAGGIO	125	BEVERLY 125	2001	2003	X	X	N
PIAGGIO	50	LIBERTY SPORT 2T	2006	2006	X	X	N	PIAGGIO	125	LIBERTY 125	1998	2002	X	X	N
PIAGGIO	50	LIBERTY SPORT 4T 50	2006	2006	X	X	N	PIAGGIO	125	SKIPPER ST 4T 125	2000	2002	X	X	N
PIAGGIO	50	ZIP SP EURO2	2006	2006	X	X	N	PIAGGIO	125	SUPER HEXAGON GTX 12"	2001	2002	X	X	N
PIAGGIO	50	APE RST MIX	1999	2005	X	X	N	PIAGGIO	125	ZIP 125	2000	2002	X	X	N
PIAGGIO	50	ICE 50	2001	2005	X	X	N	PIAGGIO	125	VESPA PX 125	1998	2001	X	X	N
PIAGGIO	50	NRG MC3	2001	2004	X	X	N	PIAGGIO	125	HEXAGON GTX 125	1998	2000	X	X	N
PIAGGIO	50	FREE FL 50	1995	2002	X	X	N	PIAGGIO	125	VESPA ET4 125	2000	2000	X	X	N
PIAGGIO	50	LIBERTY 4T 50	2000	2002	X	X	N	PIAGGIO	125	HEXAGON LX 125	1998	1999	X	X	N
PIAGGIO	50	DIESIS 50	2001	2001	X		N	PIAGGIO	125	HEXAGON LX4 125	1998	1999	X	X	N
PIAGGIO	50	FREE DELICERY	2000	2001	X	X	N	PIAGGIO	125	HEXAGON LXT 125	1998	1999	X	X	N
PIAGGIO	50	NRG EXTREME	1999	2000	X	X	N	PIAGGIO	125	SKIPPER LX 125	1998	1999	X	X	N
PIAGGIO	50	VESPA ET4 50	2000	2000	X	X	N	PIAGGIO	125	SFERA 125	1995	1995	X	X	N
PIAGGIO	50	ZIP 2T 50	2000	2000	X	X	N	PIAGGIO	150	VESPA PX 2T 150	2011	2011	X	X	N
PIAGGIO	50	ZIP 4T 50	2000	2000	X	X	N	PIAGGIO	150	VESPA S IE 4T COLLEGE 150	2010	2010	X	X	N
PIAGGIO	50	APE FL3 EUROPA	1996	1999	X	X	N	PIAGGIO	150	VESPA LX FL 150	2009	2009	X	X	N
PIAGGIO	50	VELOFAX	1996	1999	X	X	N	PIAGGIO	150	VESPA LX IE 150	2009	2009	X	X	N
PIAGGIO	50	VESPA ET2	1999	1999	X	X	N	PIAGGIO	150	VESPA LXV 150	2006	2009	X	X	N
PIAGGIO	50	NRG RST MC2	1996	1998	X	X	N	PIAGGIO	150	VESPA S IE 4T 150	2009	2009	X	X	N
PIAGGIO	50	ZIP 50	1998	1998	X	X	N	PIAGGIO	150	LIBERTY 150	2007	2008	X	X	N
PIAGGIO	50	ZIP BIMODALE	1994	1997	X	X	N	PIAGGIO	150	LIBERTY SPORT 4T 150	2008	2008	X	X	N
PIAGGIO	50	NRG	1994	1996	X	X	N	PIAGGIO	150	VESPA LX 150	2005	2008	X	X	N
PIAGGIO	50	NTT	1995	1996	X	X	N	PIAGGIO	150	VESPA S 4T 150	2007	2008	X	X	N
PIAGGIO	50	ZIP 50	1992	1996	X	X	N	PIAGGIO	150	FLY 150	2005	2005	X	X	N
PIAGGIO	50	SFERA MAQUILLAGE 2	1994	1994	X	X	N	PIAGGIO	150	LIBERTY 150	1998	2002	X	X	N
PIAGGIO	100	FLY 4T 100	2006	2008	X	X	N	PIAGGIO	150	SKIPPER ST 4T 150	2000	2002	X	X	N
PIAGGIO	100	ZIP 4T 100	2006	2008	X	X	N	PIAGGIO	150	VESPA PX 150	1998	2001	X	X	N
PIAGGIO	100	FREE	2002	2003	X	X	N	PIAGGIO	150	VESPA ET4 150	2000	2000	X	X	N
PIAGGIO	125	MP3 TOURING HYBRID 125	2011	2011	X	X	N	PIAGGIO	150	SKIPPER LX 150	1998	1999	X	X	N
PIAGGIO	125	MP3 TOURING IE 125	2011	2011	X	X	N	PIAGGIO	180	HEXAGON GTX 180	1998	2000	X	X	N
PIAGGIO	125	MP3 YOURBAN IE 125	2011	2011	X	X	N	PIAGGIO	180	HEXAGON LX 180	1998	1999	X	X	N
PIAGGIO	125	TYPHOON 4T	2011	2011	X	X	N	PIAGGIO	180	HEXAGON LXT 180	1998	1999	X	X	N
PIAGGIO	125	VESPA PX 2T 125	2011	2011	X	X	N	PIAGGIO	200	LIBERTY 200	2007	2008	X	X	N
PIAGGIO	125	BEVERLY IE 125	2010	2010	X	X	N	PIAGGIO	200	CARNABY 200	2007	2007	X	X	N
PIAGGIO	125	VESPA GTS 125	2005	2010	X	X	N	PIAGGIO	200	VESPA GRAN TURISMO 200	2003	2007	X	X	N
PIAGGIO	125	VESPA LX TOURING IE 125	2010	2010	X	X	N	PIAGGIO	200	LIBERTY SPORT	2006	2006	X	X	N
PIAGGIO	125	VESPA LXV IE 125	2010	2010	X	X	N	PIAGGIO	200	BEVERLY 200	2001	2003	X	X	N
PIAGGIO	125	VESPA S IE 4T COLLEGE 125	2010	2010	X	X	N	PIAGGIO	200	VESPA PX 200	1998	2001	X	X	N
PIAGGIO	125	BEVERLY 125	2007	2009	X	X	N	PIAGGIO	220	APE FL2	1984	2005	X	X	N
PIAGGIO	125	MP3 HYBRID	2009	2009	X	X	N	PIAGGIO	220	APE TM	1984	2005	X	X	N
PIAGGIO	125	VESPA GTV 125	2006	2009	X	X	N	PIAGGIO	250	VESPA GTS 250	2005	2010	X	X	N
PIAGGIO	125	VESPA LX FL 125	2009	2009	X	X	N	PIAGGIO	250	MP3 LT	2009	2009	X	X	N
PIAGGIO	125	VESPA LX IE 125	2009	2009	X	X	N	PIAGGIO	250	MP3 MIC 250	2008	2009	X	X	N

BRAKE/CLUTCH
MASTER CYLINDERSACCESSORIES
SPARE PARTSCNC-WORKED FLUID
RESERVOIR

FULL CLUTCH

HYDRAULIC-CLUTCH
TRANFORMATION KIT

LEVER

THROTTLE CONTROL

BRAKE CALIPER

RACING KIT

BUTTON PANEL

LEVER GUARD

CLIP-ON

STREET RACING
REARSET

FUEL CAPS

STEERING NUT

CRASH PADS

PADDOCK STAND

MIRROR COVERS

REAR-VIEW MIRRORS

FOG LIGHTS KIT

HANDLEBARS
ACCESSORIES

HANDLEBARS

Marca Brand	CC	Modello Model	Dal From	Al To	MR002 / MR003	MR001	Novità New
PIAGGIO	250	VESPA GTV 250	2006	2009	X	X	N
PIAGGIO	250	BEVERLY 250	2006	2008	X	X	N
PIAGGIO	250	BEVERLY IE 250	2006	2008	X	X	N
PIAGGIO	250	CARNABY 250	2008	2008	X	X	N
PIAGGIO	250	MP3 250	2006	2008	X	X	N
PIAGGIO	250	BEVERLY CRUISER 250	2007	2007	X	X	N
PIAGGIO	250	BEVERLY SPORT	2006	2006	X	X	N
PIAGGIO	250	BEVERLY RST 250	2004	2005	X	X	N
PIAGGIO	250	HEXAGON GT 250	1998	2000	X	X	N
PIAGGIO	250	HEXAGON GTX 250	1998	2000	X	X	N
PIAGGIO	300	MP3 TOURING HYBRID 300	2011	2011	X	X	N
PIAGGIO	300	MP3 TOURING IE 300	2011	2011	X	X	N
PIAGGIO	300	MP3 YOURBAN IE 300	2011	2011	X	X	N
PIAGGIO	300	MP3 YOURBAN LT ERL	2011	2011	X	X	N
PIAGGIO	300	BEVERLY IE 300	2009	2010	X	X	N
PIAGGIO	300	MP3 IE 4T-4V LT HYBRID	2010	2010	X	X	N
PIAGGIO	300	MP3 IE LT 300	2010	2010	X	X	N
PIAGGIO	300	MP3 IE MIC	2010	2010	X	X	N
PIAGGIO	300	VESPA GTS SUPER SPORT 300	2010	2010	X	X	N
PIAGGIO	300	VESPA GTS TOURING 300	2010	2010	X	X	N
PIAGGIO	300	VESPA GTS SUPER IE 300	2008	2008	X	X	N
PIAGGIO	400	MP3 IE LT 400	2008	2010	X	X	N
PIAGGIO	400	MP3 IE LT SPORT	2008	2010	X	X	N
PIAGGIO	400	MP3 MIC 400	2008	2009	X	X	N
PIAGGIO	400	BEVERLY 400	2008	2008	X	X	N
PIAGGIO	400	MP3 400	2006	2008	X	X	N
PIAGGIO	500	MP3 LT BUSINESS	2011	2011	X	X	N
PIAGGIO	500	MP3 LT SPORT	2011	2011	X	X	N
PIAGGIO	500	MP3 RL SPORT	2011	2011	X	X	N
PIAGGIO	500	BEVERLY (10° ANIVERSARIO)	2010	2010	X	X	N
PIAGGIO	500	BEVERLY CRUISER 500	2007	2007	X	X	N
PIAGGIO	500	BEVERLY CRUISER IE	2007	2007	X	X	N
PIAGGIO	500	BEVERLY 500	2002	2006	X	X	N
RIEJU	50	NKD 50	2003	2009	X		N
RIEJU	50	DRAC 50	2001	2001	X		N
RIEJU	50	FIRST 50	1996	1997	X		N
RIEJU	125	NKD 125	2003	2009	X		N
SHERCO	50	ENDURO 50	2004	2007	X	X	N
SHERCO	50	SUPERMOTARD 50	2004	2007	X	X	N
SHERCO	80	TRIAL 2T 80	2002	2002	X	X	N
SHERCO	125	TRIAL 2T 125	2002	2002	X	X	N
SHERCO	150	TRIAL 2T 150	2002	2002	X	X	N
SHERCO	200	TRIAL 2T 200	2002	2002	X	X	N
SHERCO	290	TRIAL 2T 290	2002	2002	X	X	N
SHERCO	320	TRIAL 4T 320	2007	2007	X	X	N
SHERCO	450	SUPERMOTARD 450	2005	2005	X	X	N
SHERCO	450	ENDURO 450	2004	2004	X	X	N
SHERCO	510	SUPERMOTARD 510	2005	2005	X	X	N
SHERCO	510	ENDURO 510	2004	2004	X	X	N
SUZUKI	50	AY 50	2001	2006	X	X	N
SUZUKI	50	AY KATANA	1997	2000	X	X	N
SUZUKI	50	AY W KATANA R	1997	2000	X	X	N
SUZUKI	50	ESTILETE	2000	2000	X	X	N
SUZUKI	50	RMX 50	1999	1999	X	X	N
SUZUKI	50	SMX 50	1999	1999	X	X	N
SUZUKI	50	UX R ZILLION	1999	1999	X	X	N
SUZUKI	50	AP50	1994	1997	X	X	N
SUZUKI	50	AH ADDRESS 50	1992	1995	X	X	N

Marca Brand	CC	Modello Model	Dal From	Al To	MR002 / MR003	MR001	Novità New
SUZUKI	100	ADDRESS 100	1993	1995	X	X	N
SUZUKI	110	UG HOKUTO	2000	2000	X	X	N
SUZUKI	125	GZ MARAUDER 125	1998	2011	X	X	N
SUZUKI	125	UX SIXTEEN 125	2008	2011	X	X	N
SUZUKI	125	DR SM 125	2009	2010	X	X	N
SUZUKI	125	UH BURGMAN 125	2002	2010	X	X	N
SUZUKI	125	ADDRESS 125	2009	2009	X	X	N
SUZUKI	125	RV VAN VAN 125	2003	2007	X	X	N
SUZUKI	125	VL INTRUDER 125	2005	2007	X	X	N
SUZUKI	125	EPICURO 125	1999	2001	X	X	N
SUZUKI	125	UE CT 125	2001	2001	X	X	N
SUZUKI	125	VL INTRUDER 125	2000	2001	X	X	N
SUZUKI	125	AN 125	1995	2000	X	X	N
SUZUKI	125	GN 125	1982	1996	X	X	N
SUZUKI	125	TS 125 R	1989	1994	X	X	N
SUZUKI	150	UX SIXTEEN 150	2008	2011	X	X	N
SUZUKI	150	UH BURGMAN 150	2002	2006	X	X	N
SUZUKI	150	EPICURO 150	1999	2001	X	X	N
SUZUKI	150	UE CT 150	2001	2001	X	X	N
SUZUKI	150	AN 150	1995	2000	X	X	N
SUZUKI	200	UH BURGMAN 200	2007	2010	X	X	N
SUZUKI	250	GZ MARAUDER 250	1999	2007	X	X	N
SUZUKI	250	VL INTRUDER 250	2005	2007	X	X	N
SUZUKI	250	AN BURGMAN 250	1998	2006	X	X	N
SUZUKI	250	TU-X 250	1997	2001	X	X	N
SUZUKI	250	VL INTRUDER 250	2000	2001	X	X	N
SUZUKI	250	GN 250	1982	1996	X	X	N
SUZUKI	350	DR S 350	1990	1998	X	X	N
SUZUKI	350	DR SE 350	1990	1998	X	X	N
SUZUKI	400	AN BURGMAN 400	1999	2016	X	X	N
SUZUKI	400	DR-Z S 400	2000	2009	X	X	N
SUZUKI	400	DR-Z SM 400	2005	2009	X	X	N
SUZUKI	400	DR-Z E 400	2005	2007	X	X	N
SUZUKI	400	DR-Z 400	2000	2003	X	X	N
SUZUKI	400	GSF BANDIT 400	1991	1993	X	X	N
SUZUKI	500	GS 500	1989	2006	X	X	N
SUZUKI	550	GSX E 550	1985	1987	X	X	N
SUZUKI	600	GSR 600	2006	2008	X	X	N
SUZUKI	600	GSF BANDIT 600	1995	2006	X	X	N
SUZUKI	600	VS INTRUDER 600	1985	1998	X	X	N
SUZUKI	600	DR R 600	1985	1989	X	X	N
SUZUKI	600	DR S 600	1985	1989	X	X	N
SUZUKI	650	SV 650	2017	2018	X	X	N
SUZUKI	650	SVF GLADIUS 650	2012	2015	X	X	N
SUZUKI	650	DL V-STROM 650 ABS	2012	2012	X	X	N
SUZUKI	650	GSF BANDIT 650	2009	2012	X	X	N
SUZUKI	650	DL V-STROM 650	2004	2011	X	X	N
SUZUKI	650	SVF GLADIUS 650	2009	2011	X	X	N
SUZUKI	650	SV 650	2003	2010	X	X	N
SUZUKI	650	GSF BANDIT 650	2007	2008	X	X	N
SUZUKI	650	GSF BANDIT 650	2005	2006	X	X	N
SUZUKI	650	XF FREEWIND	1997	2001	X	X	N
SUZUKI	650	DR SE 650	1996	1997	X	X	N
SUZUKI	650	LS SAVAGE 650	1986	1997	X	X	N
SUZUKI	650	DR RE 650	1994	1995	X	X	N
SUZUKI	650	DR R 650	1990	1993	X	X	N
SUZUKI	650	DR RSE 650	1991	1993	X	X	N
SUZUKI	650	DR RS 650	1990	1991	X	X	N

- BRAKE/CLUTCH MASTER CYLINDERS
- ACCESSORIES SPARE PARTS
- CNC-WORKED FLUID RESERVOIR
- FULL CLUTCH
- HYDRAULIC-CLUTCH TRANFORMATION KIT
- LEVER
- THROTTLE CONTROL
- BRAKE CALIPER
- RACING KIT
- BUTTON PANEL
- LEVER GUARD
- CLIP-ON
- STREET RACING REARSET
- FUEL CAPS
- STEERING NUT
- CRASH PADS
- PADDOCK STAND
- MIRROR COVERS
- REAR-VIEW MIRRORS
- FOG LIGHTS KIT
- HANDLEBARS ACCESSORIES
- HANDLEBARS

Marca Brand	CC	Modello Model	Dal From	Al To	MR002 / MR003	MR001	Novità New	Marca Brand	CC	Modello Model	Dal From	Al To	MR002 / MR003	MR001	Novità New
SUZUKI	750	GSX-S 750	2017	2019	X	X	N	SYM	180	JOYRIDE EVO 180	2010	2010	X	X	N
SUZUKI	750	GSR 750	2011	2016	X	X	N	SYM	180	JOYRIDE 180	2005	2008	X	X	N
SUZUKI	750	GSX 750	1998	2001	X	X	N	SYM	200	HD2 I	2011	2011	X	X	N
SUZUKI	750	VS INTRUDER 750	1985	1998	X	X	N	SYM	200	JOYRIDE I	2008	2009	X	X	N
SUZUKI	750	DR 750	1988	1989	X	X	N	SYM	200	JOYRIDE I EVO	2009	2009	X	X	N
SUZUKI	800	VL INTRUDER 800	2006	2014	X	X	N	SYM	200	FIDDLE II 200	2008	2008	X	X	N
SUZUKI	800	INTRUDER C 800	2006	2010	X	X	N	SYM	200	HD EVO EFI EVO	2008	2008	X	X	N
SUZUKI	800	VL K7	2001	2010	X	X	N	SYM	200	HD 200	2007	2007	X	X	N
SUZUKI	800	VL INTRUDER VOLUSIA	2001	2005	X	X	N	SYM	200	HD EVO 200	2005	2005	X	X	N
SUZUKI	800	VZ INTRUDER M	2005	2005	X	X	N	SYM	200	JOYRIDE EURO 2 200	2003	2003	X	X	N
SUZUKI	800	VZ MARAUDER	1997	2002	X	X	N	SYM	400	MAXSYM 400I	2011	2011	X	X	N
SUZUKI	800	VS INTRUDER 800	1985	1998	X	X	N	TGB	50	EXPRESS 2T	2009	2009	X		N
SUZUKI	800	VX 800	1990	1994	X	X	N	TGB	50	R 50 X	2009	2009	X		N
SUZUKI	800	DR S 800	1991	1993	X	X	N	TGB	50	101S	2008	2008	X	X	N
SUZUKI	1000	GSX-S 1000	2016	2019	X	X	N	TGB	125	EXPRESS 4T	2009	2009	X		N
SUZUKI	1000	GSX-S 1000 KATANA	2019	2019	X	X	N	TGB	325	BLADE LE 325	2009	2009	X		N
SUZUKI	1000	DL V-STROM 1000	2002	2011	X	X	N	TGB	325	TARGET 4X2 325	2009	2009	X		N
SUZUKI	1000	SV 1000	2003	2007	X	X	N	TGB	400	AVENGER LE 4X2	2009	2009	X		N
SUZUKI	1200	GSF BANDIT 1200	2001	2006	X	X	N	TGB	400	TARGET 4X2 400	2009	2009	X		N
SUZUKI	1200	GSX X 1200	1999	2001	X	X	N	TGB	425	BLADE SE 425	2009	2009	X		N
SUZUKI	1250	GSF BANDIT 1250	2007	2007	X	X	N	TGB	425	TARGET 4X4 425	2009	2009	X		N
SUZUKI	1300	GSX B-KING 1300	2008	2010	X	X	N	TGB	450	BLADE SE 450	2009	2009	X		N
SUZUKI	1400	VS INTRUDER 1400	1985	1998	X	X	N	TGB	500	AVENGER R 4X2	2009	2009	X		N
SUZUKI	1500	VL INTRUDER M	2009	2009	X	X	N	TGB	500	TARGET 4X2 500	2009	2009	X		N
SUZUKI	1500	VL INTRUDER LC 1500	1998	2008	X	X	N	TGB	525	BLADE SE 525	2009	2009	X		N
SUZUKI	1800	VZR INTRUDER M R	2006	2016	X	X	N	TGB	525	BLADE SL 525	2009	2009	X		N
SUZUKI	1800	INTRUDER C 1800 R	2008	2011	X	X	N	TGB	525	GUNNER	2009	2009	X		N
SYM	50	FIDDLE II S 50	2010	2010	X	X	N	TGB	525	TARGET 4X4 525	2009	2009	X		N
SYM	50	JET 4 R NAKED	2010	2010	X	X	N	TGB	550	BLADE SE 550	2009	2009	X		N
SYM	50	SYMPHONY 50	2010	2010	X	X	N	TGB	550	BLADE SL 550	2009	2009	X		N
SYM	50	FIDDLE II 50	2008	2008	X	X	N	TRIUMPH	675	STREET TRIPLE / R	2008	2019	X		N
SYM	50	FIDDLE 50	2000	2007	X	X	N	TRIUMPH	675	STREET TRIPLE RS	2017	2019			
SYM	50	JET SPORT X R	2006	2006	X	X	N	TRIUMPH	675	STREET TRIPLE RX	2015	2015	X		N
SYM	50	JET SPORT X S	2006	2006	X	X	N	TRIUMPH	800	TIGER 800 / EXPLORER	2011	2011	X		N
SYM	50	JET SPORT X SR	2006	2006	X	X	N	YAMAHA	50	NS AEROX F	2014	2018	X		N
SYM	50	MIO 50	2005	2005	X	X	N	YAMAHA	50	YN F NEO'S 50	2007	2018	X		N
SYM	50	DD 50	2002	2002	X	X	N	YAMAHA	50	BW'S 50	2003	2016	X		N
SYM	100	MIO 100	2005	2005	X	X	N	YAMAHA	50	BW'S NAKED 50	2003	2016	X		N
SYM	125	HD2	2011	2011	X	X	N	YAMAHA	50	NS AEROX	2013	2016	X		N
SYM	125	FIDDLE II S 125	2010	2010	X	X	N	YAMAHA	50	NS AEROX NAKED	2013	2016	X		N
SYM	125	SB NI WOLF	2010	2010	X	X	N	YAMAHA	50	BW'S EASY 50	2013	2013	X		N
SYM	125	SYMPHONY 125	2010	2010	X	X	N	YAMAHA	50	YQ AEROX 50	1997	2012	X		N
SYM	125	JOYRIDE 125	2007	2009	X	X	N	YAMAHA	50	CS JOG R	2002	2011	X		N
SYM	125	JOYRIDE EVO 125	2009	2009	X	X	N	YAMAHA	50	CS JOG RR	2002	2011	X		N
SYM	125	FIDDLE II 125	2008	2008	X	X	N	YAMAHA	50	XF GIGGLE	2008	2008	X		N
SYM	125	HD 125	2007	2007	X	X	N	YAMAHA	50	YN R NEO'S 50	1997	2008	X		N
SYM	125	HD EVO 125	2007	2007	X	X	N	YAMAHA	50	BW'S NEXT GENERATION 50	1997	2006	X		N
SYM	125	VS 125	2006	2006	X	X	N	YAMAHA	50	DT R 50	2006	2006	X		N
SYM	125	JOYRIDE EURO 2 125	2003	2003	X	X	N	YAMAHA	50	DT X 50	2006	2006	X		N
SYM	125	EURO MX 125	2002	2002	X	X	N	YAMAHA	50	YH WHY 50	1998	2006	X		N
SYM	125	EURO MX 125 DD	2002	2002	X	X	N	YAMAHA	50	CW BW'S	2002	2004	X		N
SYM	125	SHARK 125	2000	2000	X	X	N	YAMAHA	50	BW'S ORIGINAL 50	1997	2003	X		N
SYM	150	SYMPHONY 150	2010	2010	X	X	N	YAMAHA	50	EW SLIDWER 50	2000	2002	X		N
SYM	150	FIDDLE II 150	2008	2008	X	X	N	YAMAHA	50	BW'S 50 R	2001	2001	X		N
SYM	150	VS 150	2006	2006	X	X	N	YAMAHA	50	BW'S BUMP 50	1997	1998	X		N
SYM	150	JOYRIDE EURO 2 150	2003	2003	X	X	N	YAMAHA	50	CW RS SPY	1995	1998	X		N
SYM	150	EURO MX 150	2002	2002	X	X	N	YAMAHA	50	SPY RS	1995	1998	X		N
SYM	150	SHARK 150	2000	2000	X	X	N	YAMAHA	50	Y A R AXIX	1995	1996	X		N

BRAKE/CLUTCH
MASTER CYLINDERS
 ACCESSORIES
SPARE PARTS
 CNC-WORKED FLUID
RESERVOIR
 FULL CLUTCH
 HYDRAULIC-CLUTCH
TRANFORMATION KIT
 LEVER
 THROTTLE CONTROL
 BRAKE CALIPER
 RACING KIT
 BUTTON PANEL
 LEVER GUARD
 CLIP-ON
 STREET RACING
REARSET
 FUEL CAPS
 STEERING NUT
 CRASH PADS
 PADDOCK STAND
 MIRROR COVERS
 REAR-VIEW MIRRORS
 FOG LIGHTS KIT
 HANDLEBARS
ACCESSORIES
 HANDLEBARS

Marca Brand	CC	Modello Model	Dal From	Al To	MR002 / MR003	MR001	Novità New	Marca Brand	CC	Modello Model	Dal From	Al To	MR002 / MR003	MR001	Novità New
YAMAHA	100	YN NEO'S 100	1999	2002	X		N	YAMAHA	535	XV VIRAGO 535	1989	1998	X		N
YAMAHA	100	BW'S 100	1999	2001	X		N	YAMAHA	535	XV SE VIRAGO	1988	1988	X		N
YAMAHA	125	YP R X-MAX ABS 125	2010	2017	X		N	YAMAHA	600	XJ6 NA ABS	2011	2015	X		N
YAMAHA	125	YP R X-MAX 125	2006	2016	X		N	YAMAHA	600	XJ6 N	2009	2013	X		N
YAMAHA	125	WR 125 X	2008	2014	X		N	YAMAHA	600	XJ6 N SP	2013	2013	X		N
YAMAHA	125	XC MAJESTY 125 R	2014	2014	X		N	YAMAHA	600	FZ6 S2 600	2007	2009	X		N
YAMAHA	125	YBR 125	2005	2014	X		N	YAMAHA	600	FZ6 600	2004	2007	X		N
YAMAHA	125	NXC CYGNUS X	2004	2011	X		N	YAMAHA	600	FZ6 NS 600	2005	2006	X		N
YAMAHA	125	VITY 125	2008	2011	X		N	YAMAHA	600	XJ 600 S DIVERSION	1992	2002	X		N
YAMAHA	125	VP X-CITY 125	2007	2011	X		N	YAMAHA	600	XT 600 E	1993	2002	X		N
YAMAHA	125	WR 125 R	2008	2011	X		N	YAMAHA	600	XJ 600 N	1995	2001	X		N
YAMAHA	125	YP R X-MAX SPORT 125	2011	2011	X		N	YAMAHA	600	XT 600	1998	1998	X		N
YAMAHA	125	YW BW'S	2010	2010	X		N	YAMAHA	600	XT 600 K	1993	1993	X		N
YAMAHA	125	YP E MAJESTY 125	2003	2009	X		N	YAMAHA	600	SRX	1986	1987	X		N
YAMAHA	125	XT 125 R	2005	2008	X		N	YAMAHA	650	XVS A DRAG STAR CLASSIC 650	1998	2006	X		N
YAMAHA	125	XT 125 X / XT 125 R	2005	2008	X		N	YAMAHA	660	XT Z TÉNÉRÉ	2008	2015	X		N
YAMAHA	125	DT R BRA 125	2007	2007	X		N	YAMAHA	660	XT ZA TÉNÉRÉ	2011	2015	X		N
YAMAHA	125	DT RE 125	2004	2006	X		N	YAMAHA	660	XT 660 R	2004	2014	X		N
YAMAHA	125	DT X 125	2005	2006	X		N	YAMAHA	660	MT-03	2006	2012	X		N
YAMAHA	125	XC CYGNUS 125	2000	2004	X		N	YAMAHA	660	XT 660 X	2004	2011	X		N
YAMAHA	125	XQ MAXTER 125	2001	2002	X		N	YAMAHA	660	XT Z TÉNÉRÉ	1991	1996	X		N
YAMAHA	125	YP MAJESTY 125	1998	2002	X		N	YAMAHA	700	MT-07 A	2017	2017	X		N
YAMAHA	125	SR SP	1999	2000	X		N	YAMAHA	700	MT-07	2013	2016	X		N
YAMAHA	125	XN TEO'S 125	2000	2000	X		N	YAMAHA	700	MT-07 A ABS	2014	2016	X		N
YAMAHA	125	XV VIRAGO 125	1997	2000	X		N	YAMAHA	700	MT-07 MOTO CAGE	2014	2014	X		N
YAMAHA	125	XC BELUGA 125	1990	1995	X		N	YAMAHA	750	XV VIRAGO 750	1992	1995	X		N
YAMAHA	150	YP E MAJESTY 150	2003	2009	X		N	YAMAHA	750	FZX	1988	1988	X		N
YAMAHA	150	XC CYGNUS 150	2000	2006	X		N	YAMAHA	800	FZ8 N	2010	2012	X		N
YAMAHA	150	XN TEO'S 150	2001	2002	X		N	YAMAHA	800	FZ8 NA	2011	2012	X		N
YAMAHA	150	XQ MAXTER 150	2001	2002	X		N	YAMAHA	850	MT-09 (MTN850D)	2017	2019	X		N
YAMAHA	150	YP MAJESTY 150	1998	2002	X		N	YAMAHA	850	MT-09 SP (MTN850D)	2018	2018	X		N
YAMAHA	180	YP MAJESTY 180	2003	2006	X		N	YAMAHA	850	MT-09	2013	2016	X		N
YAMAHA	250	YP R X-MAX 250	2007	2016	X		N	YAMAHA	850	MT-09 A ABS	2014	2016	X		N
YAMAHA	250	YP R X-MAX ABS 250	2010	2016	X		N	YAMAHA	850	TDM 850	1991	2001	X		N
YAMAHA	250	VP X-CITY 250	2007	2015	X		N	YAMAHA	900	MT-09 TRACER 900	2015	2019	X		N
YAMAHA	250	YP R X-MAX SPORT 250	2011	2012	X		N	YAMAHA	900	MT-09 TRACER GT 900	2018	2019	X		N
YAMAHA	250	YBR 250	2007	2011	X		N	YAMAHA	900	TDM 900	2002	2010	X		N
YAMAHA	250	YP R BLACK X-MAX 125	2009	2009	X		N	YAMAHA	900	TDM 900 ABS	2005	2010	X		N
YAMAHA	250	WR 250 X	2008	2008	X		N	YAMAHA	950	XV950R	2014	2017	X		N
YAMAHA	250	DT X 250	2005	2005	X		N	YAMAHA	950	XVS A DRAG STAR CLASSIC 950	2009	2012	X		N
YAMAHA	250	XG TRICKER	2005	2005	X		N	YAMAHA	1000	FZ1 1000	2006	2009	X		N
YAMAHA	250	YP MAJESTY 250	1996	2003	X		N	YAMAHA	1000	XV SE VIRAGO	1988	1988	X		N
YAMAHA	250	YP MAJESTY 250 ABS	1998	2003	X		N	YAMAHA	1100	BT BULLDOG	2002	2006	X		N
YAMAHA	250	YP MAJESTY 250 DX	1998	2003	X		N	YAMAHA	1100	XVS A DRAG STAR CLASSIC 1100	1999	2006	X		N
YAMAHA	250	XV S VIRAGO	1997	1999	X		N	YAMAHA	1100	XV VIRAGO 1100	1989	1997	X		N
YAMAHA	250	XV VIRAGO 250	1991	1996	X		N	YAMAHA	1200	XT Z SUPER TÉNÉRÉ	2010	2013	X		N
YAMAHA	250	XV H VIRAGO	1989	1989	X		N	YAMAHA	1200	V-MAX 1200	1986	2001	X		N
YAMAHA	250	SR SPECIAL	1985	1985	X		N	YAMAHA	1200	XJR 1200	1995	1997	X		N
YAMAHA	300	XC VERSITY	2003	2006	X		N	YAMAHA	1300	XVS A MIDNIGHT STAR 1300	2007	2016	X		N
YAMAHA	320	MT-03 A	2016	2019	X		N	YAMAHA	1300	XJR 1300	2007	2013	X		N
YAMAHA	400	YP X-MAX 400 ABS	2014	2017	X		N	YAMAHA	1300	XJR 1300 / XJR 1300 SP	1999	2001	X		N
YAMAHA	400	SR 400	2014	2016	X		N	YAMAHA	1300	XVZ ROYAL STAR 1300	1996	2000	X		N
YAMAHA	400	YP X-MAX 400	2013	2016	X		N	YAMAHA	1600	XV A WILD STAR	1999	2002	X		N
YAMAHA	400	YP X-MAX 400 IRONMAX	2016	2016	X		N	YAMAHA	1700	V-MAX 1700	2009	2015	X		N
YAMAHA	400	YP X-MAX 400 MOMODESIGN / ABS	2014	2014	X		N	YAMAHA	1700	MT-01	2005	2009	X		N
YAMAHA	400	YP MAJESTY 400	2004	2011	X		N	YAMAHA	1700	MT-01S	2009	2009	X		N
YAMAHA	400	YP MAJESTY 400 ABS	2007	2011	X		N								
YAMAHA	535	XV VIRAGO 535 DX	2000	2001	X		N								

BRAKE/CLUTCH
MASTER CYLINDERS
 ACCESSORIES
SPARE PARTS
 CNC-WORKED FLUID
RESERVOIR
 FULL CLUTCH
 HYDRAULIC-CLUTCH
TRANFORMATION KIT
 LEVER
 THROTTLE CONTROL
 BRAKE CALIPER
 RACING KIT
 BUTTON PANEL
 LEVER GUARD
 CLIP-ON
 STREET RACING
REARSET
 FUEL CAPS
 STEERING NUT
 CRASH PADS
 PADDOCK STAND
 MIRROR COVERS
 REAR-VIEW MIRRORS
 FOG LIGHTS KIT
 HANDLEBARS
ACCESSORIES
 HANDLEBARS

ADATTATORI SPECCHIETTO

REAR VIEW MIRROR ADAPTER

AD006



AD007



AD008



Marca Brand	CC	Modello Model	Anno dal From	Anno al To	Codice Code	Note	Novità New
BMW	650	G650 GS	2011	2016	AD010		N
BMW	800	F800 GS	2008	2017	AD010		N
BMW	800	F800R	2009	2019	AD010		N
BMW	1000	S 1000 RR	2010	2010	AD008		N
BMW	1000	S 1000 RR	1000	2010	AD007		N
BMW	1200	R 1200 GS / RALLYE / ADVENTURE	2004	2018	AD010		N
BMW	1200	K1200 R SPORT	2007	2010	AD010		N
BMW	1200	K1200R	2005	2008	AD010		N
BMW	1200	R1200R/CLASSIC	2006	2015	AD010		N
BMW	1200	R NINE T RACER	2017	2019	AD011		N
BMW	1250	R 1250 GS / HP / ADVENTURE	2018	2019	AD010		N
BMW	1300	K1300R	2009	2016	AD010		N
DUCATI	959	959 PANIGALE	2018	2018	AD015		N
DUCATI	1100	PANIGALE V4 / V4 S / V4 SPECIALE	2018	2018	AD016		N
DUCATI	1200	DIAVEL / XDIAVEL	2011	2018	AD010		N
DUCATI	1299	1299 PANIGALE / PANIGALE S	2015	2018	AD015		N
HONDA	600	CBR 600 F	1999	2006	AD008		N
HONDA	600	CBR 600 FS	2001	2002	AD008		N
HONDA	600	CBR 600 RR	2003	2008	AD008		N
HONDA	600	CB 600 S HORNET	2002	2004	AD008		N
HONDA	600	CBR 600 F	1999	2006	AD007		N
HONDA	600	CBR 600 FS	2001	2002	AD007		N
HONDA	600	CBR 600 RR	2003	2008	AD007		N
HONDA	600	CB 600 S HORNET	2002	2004	AD007		N
HONDA	600	CBR 600 RR	2009	2009	AD006		N
HONDA	900	CBR 900 RR	2002	2004	AD008		N
HONDA	900	CBR 900 RR	2002	2004	AD007		N
HONDA	1000	CBR 1000 RR	2004	2007	AD008		N
HONDA	1000	VTR SP1	2000	2002	AD008		N
HONDA	1000	VTR SP2	2002	2006	AD008		N
HONDA	1000	CBR 1000 RR	2004	2007	AD007		N
HONDA	1000	VTR SP1	2000	2002	AD007		N
HONDA	1000	VTR SP2	2002	2006	AD007		N
HUSQVARNA	900	NUDA	2012	2014	AD010		N
KAWASAKI	125	NINJA 125	2019	2020	AD012		N
KAWASAKI	250	NINJA 250 SL	2015	2016	AD012		N

BRAKE/CLUTCH
MASTER CYLINDERS
 ACCESSORIES
SPARE PARTS
 CNC-WORKED FLUID
RESERVOIR
 FULL CLUTCH
 HYDRAULIC-CLUTCH
TRANFORMATION KIT
 LEVER
 THROTTLE CONTROL
 BRAKE CALIPER
 RACING KIT
 BUTTON PANEL
 LEVER GUARD
 CLIP-ON
 STREET RACING
REARSET
 FUEL CAPS
 STEERING NUT
 CRASH PADS
 PADDOCK STAND
 MIRROR COVERS
 REAR-VIEW MIRRORS
 FOG LIGHTS KIT
 HANDLEBARS
ACCESSORIES
 HANDLEBARS

Marca Brand	CC	Modello Model	Anno dal From	Anno al To	Codice Code	Note	Novità New
KAWASAKI	300	VERSYS-X 300	2017	2019	AD010		N
KAWASAKI	300	NINJA 300	2012	2016	AD012		N
KAWASAKI	600	ER-6F	2005	2008	AD008		N
KAWASAKI	600	ZX-6R	2001	2004	AD008		N
KAWASAKI	600	ER-6F	2011	2016	AD006		N
KAWASAKI	600	ER-6F ABS	2012	2016	AD006		N
KAWASAKI	600	NINJA 600 ZX-6 R	1995	2016	AD012		N
KAWASAKI	600	GPX 600 R	1988	1990	AD012		N
KAWASAKI	636	NINJA 600 / 636 ZX-6R	2005	2008	AD008		N
KAWASAKI	636	NINJA 600 / 636 ZX-6R	2005	2008	AD007		N
KAWASAKI	636	NINJA 636 ZX-6 R	2002	2004	AD012		N
KAWASAKI	650	NINJA 650	2017	2019	AD012		N
KAWASAKI	750	Z750 S	2005	2006	AD008		N
KAWASAKI	750	Z750 R	2010	2012	AD010		N
KAWASAKI	750	GPX 750 R	1987	1989	AD012		N
KAWASAKI	750	NINJA 700 ZX-7 R	1996	2002	AD012		N
KAWASAKI	750	NINJA 700 ZX-7 RR	1996	1998	AD012		N
KAWASAKI	900	ZX-9R	1999	2003	AD008		N
KAWASAKI	900	NINJA 900 ZX-9 R	1994	2003	AD012		N
KAWASAKI	1000	NINJA 1000 ZX-10R	2004	2007	AD008		N
KAWASAKI	1000	NINJA 1000 ZX-10R	2004	2007	AD007		N
KAWASAKI	1000	Z1000	2003	2019	AD010		N
KAWASAKI	1000	VERSYS 1000	2012	2019	AD010		N
KAWASAKI	1000	GPZ 1000 RX	1986	1988	AD012		N
KAWASAKI	1000	ZX-10	1988	1990	AD012		N
KAWASAKI	1000	NINJA 1000 ZX-10R	2008	2010	AD018		N
KAWASAKI	1100	ZZR 1100	1990	1999	AD012		N
KAWASAKI	1200	NINJA 1200 ZX-12 R	2000	2006	AD012		N
KAWASAKI	1200	ZRX 1200 S	2001	2004	AD012		N
KTM	1290	1290 SUPER ADVENTURE S	2017	2019	AD010		N
KTM	1290	1290 SUPER DUKE R	2014	2019	AD010		N
MV AGUSTA	675	F3 675	2012	2019	AD018		N
MV AGUSTA	1000	F4 1000	2004	2015	AD018		N
SUZUKI	500	GS 500	2003	2007	AD006		N
SUZUKI	600	GSXR 600	2001	2007	AD006		N
SUZUKI	600	GSF600 S BANDIT	2000	2004	AD006		N
SUZUKI	600	GSX-R600	2006	2016	AD018		N
SUZUKI	650	GSX 650 F	2008	2012	AD006		N
SUZUKI	650	GSF 650 BANDIT	2005	2008	AD006		N
SUZUKI	650	SV650 S	2003	2008	AD006		N
SUZUKI	750	GSXR 750	2000	2007	AD006		N
SUZUKI	750	GSX-R750	2006	2016	AD018		N
SUZUKI	1000	GSXR 1000	2001	2008	AD006		N
SUZUKI	1000	SV1000 S	2003	2007	AD006		N
SUZUKI	1000	GSX-R 1000	2006	2016	AD018		N
SUZUKI	1200	GSF1200 S BANDIT	2001	2005	AD006		N
SUZUKI	1250	GSX 1250 FA	2010	2016	AD006		N
SUZUKI	1300	GSZ 1300 R HAYABUSA	1999	2013	AD006		N
SUZUKI	1300	GSX 1300 RA HAYABUSA	2014	2017	AD006		N
TRIUMPH	675	DAYTONA 675	2009	2009	AD008		N
TRIUMPH	675	DAYTONA 675	2006	2008	AD008		N
YAMAHA	500	T-MAX 500	2008	2011	AD009		N
YAMAHA	530	T-MAX 530	2012	2014	AD009		N
YAMAHA	600	YZF-R6	1999	2003	AD008		N
YAMAHA	600	YZF-R6	2008	2016	AD008		N
YAMAHA	600	YZF-R6	2003	2007	AD008		N
YAMAHA	600	YZF-R6	2017	2019	AD013		N
YAMAHA	1000	FZ1 FAZER	2006	2009	AD008		N
YAMAHA	1000	YZF-R1	2000	2001	AD008		N
YAMAHA	1000	YZF-R1	2009	2014	AD008		N
YAMAHA	1000	FZ1 FAZER	2006	2010	AD007		N

BRAKE/CLUTCH
 MASTER CYLINDERS
 ACCESSORIES
 SPARE PARTS
 CNC-WORKED FLUID
 RESERVOIR
 FULL CLUTCH
 HYDRAULIC-CLUTCH
 TRANFORMATION KIT
 LEVER
 THROTTLE CONTROL
 BRAKE CALIPER
 RACING KIT
 BUTTON PANEL
 LEVER GUARD
 CLIP-ON
 STREET RACING
 REARSET
 FUEL CAPS
 STEERING NUT
 CRASH PADS
 PADDOCK STAND
 MIRROR COVERS
 REAR-VIEW MIRRORS
 FOG LIGHTS KIT
 HANDLEBARS
 ACCESSORIES
 HANDLEBARS

KIT PROIETTORI FENDINEBBIA E SUPPORTI

LED FOG LIGHTS KIT



Codice Reference	Descrizione Description	Caratteristiche tecniche Technical details
FN001	Kit proiettori fendinebbia universali, con tecnologia a led e corpo in alluminio senza staffa <i>Universal led fog light kit, aluminium-made with led technology without bracket</i>	Assorbimento luci a led / <i>Led-light absorption power: 10 W Cad. / Each</i> Resistente all'acqua / <i>Water resistance: IP68</i> Connettore / <i>Connector: 2-PIN</i> Temperatura di esercizio / <i>Operating temperatures: -40° / +85°</i> Peso / <i>Weight: 320 Gr</i> Input: 9-50 V Lumen: 900
Codice Reference	Descrizione Description	Contenuto Contents
FN002	Kit proiettori fendinebbia universali, con staffe di supporto <i>Accosato universal kit, including fog light kit provided with brackets</i>	Una coppia di proiettori fendinebbia (FN001) Una coppia di staffe di supporto (FS001) <i>A pair of fog light (FN001) Brackets (FS001)</i>
Codice Reference	Descrizione Description	Caratteristiche tecniche Technical details
FS001	Staffa di supporto per proiettori fendinebbia <i>Fog-light brackets</i>	Per tubi Ø da 25 mm a 32 mm <i>Brackets suitable for rods Ø from 25 mm to 32 mm</i>

- BRAKE/CLUTCH MASTER CYLINDERS
- ACCESSORIES SPARE PARTS
- CNC-WORKED FLUID RESERVOIR
- FULL CLUTCH
- HYDRAULIC-CLUTCH TRANSFORMATION KIT
- LEVER
- THROTTLE CONTROL
- BRAKE CALIPER
- RACING KIT
- BUTTON PANEL
- LEVER GUARD
- CLIP-ON
- STREET RACING REARSET
- FUEL CAPS
- STEERING NUT
- CRASH PADS
- Paddock STAND
- MIRROR COVERS
- REAR-VIEW MIRRORS
- FOG LIGHTS KIT
- HANDLEBARS ACCESSORIES
- HANDLEBARS

CATADIOTTO

RETROREFLECTOR



Codice Reference	Descrizione Description	Colori Colours
CD001	Supporto catadiottro / Support retroreflector license plate	● nero - black
CD002	Catadiottro / Retroreflector license plate	
CD003	Supporto catadiottro con catadiottro Support retroreflector license plate with retroreflector license plate	● nero - black

- BRAKE/CLUTCH MASTER CYLINDERS
- ACCESSORIES SPARE PARTS
- CNC-WORKED FLUID RESERVOIR
- FULL CLUTCH
- HYDRAULIC-CLUTCH TRANSFORMATION KIT
- LEVER
- THROTTLE CONTROL
- BRAKE CALIPER
- RACING KIT
- BUTTON PANEL
- LEVER GUARD
- CLIP-ON
- STREET RACING REARSET
- FUEL CAPS
- STEERING NUT
- CRASH PADS
- Paddock STAND
- MIRROR COVERS
- REAR-VIEW MIRRORS
- FOG LIGHTS KIT
- HANDLEBARS ACCESSORIES
- HANDLEBARS

CONTRAPPESI

HANDLEBAR ENDS



Codice
Reference

Descrizione
Description

TK001 Contrappeso per manubri con foro interno Ø da 12mm a 20mm
Handlebar end suitable for handlebars Ø from 12mm to 20mm

Colori / Colours

N

nero - black

O

arancione
orange

Y

oro - gold

B

blu - blue

R

rosso - red

S

argento - silver

G

verde - green



Codice
Reference

Descrizione
Description

TK002 Contrappeso con inserto colorato, per manubri con foro interno, Ø da 12mm a 20mm
Handlebar end with coloured insert, suitable for handlebars Ø from 12mm to 20mm

Colori
Colours

O

arancione
orange

Y

oro - gold

B

blu - blue

R

rosso - red

S

argento - silver

G

verde - green



Codice
Reference

Descrizione
Description

TK004 Contrappeso per manubri con foro interno Ø da 12mm a 20mm
Handlebar end suitable for handlebars Ø from 12mm to 20mm

Colori / Colours

N

nero - black

O

arancione
orange

Y

oro - gold

B

blu - blue

R

rosso - red

S

argento - silver

G

verde - green

BRAKE/CLUTCH
MASTER CYLINDERS

ACCESSORIES
SPARE PARTS

CNC-WORKED FLUID
RESERVOIR

FULL CLUTCH

HYDRAULIC-CLUTCH
TRANSFORMATION KIT

LEVER

THROTTLE CONTROL

BRAKE CALIPER

RACING KIT

BUTTON PANEL

LEVER GUARD

CLIP-ON

STREET RACING
REARSET

FUEL CAPS

STEERING NUT

CRASH PADS

Paddock STAND

MIRROR COVERS

REAR-VIEW MIRRORS

FOG LIGHTS KIT

HANDLEBARS
ACCESSORIES

HANDLEBARS

Applicazioni / Application list

Marca Brand	CC	Modello Model	Anno dal From	Anno al To	Novità New	Marca Brand	CC	Modello Model	Anno dal From	Anno al To	Novità New
APRILIA	660	PEGASO STRADA - FACTORY - TRAIL	2005	2009	N	DUCATI	848	STREETFIGHTER 848	2008	2015	
APRILIA	750	DORSODURO 750	2008	2016	N	DUCATI	848	STREETFIGHTER 848	2012	2015	N
APRILIA	750	SHIVER 750	2007	2015		DUCATI	850	848	2008	2011	
APRILIA	750	DORSODURO 750 FACTORY	2010	2013	N	DUCATI	899	PANIGALE 899	2013	2015	
APRILIA	850	MANA GT	2009	2016	N	DUCATI	900	900 SS	1998	2002	N
APRILIA	850	MANA	2007	2011	N	DUCATI	996	996	1999	2001	N
APRILIA	900	DORSODURO 900	2017	2018	N	DUCATI	998	998	2002	2003	N
APRILIA	1000	RSV4	2009	2019		DUCATI	999	999 R - S	2003	2006	N
APRILIA	1000	TUONO	2006	2009		DUCATI	1000	SPORT 1000 S	2007	2009	N
APRILIA	1000	RSV 1000	2004	2008		DUCATI	1000	DESMOSEDICI RR	2008	2008	N
APRILIA	1000	ETV CAPONORD	2001	2007	N	DUCATI	1000	1000 SS	2003	2006	N
APRILIA	1100	TUONO V4	2011	2019		DUCATI	1000	PAUL SMART	2006	2006	N
APRILIA	1200	CAPONORD	2013	2016	N	DUCATI	1100	STREETFIGHTER 1100	2008	2015	
APRILIA	1200	DORSODURO 1200	2010	2016	N	DUCATI	1100	MONSTER 1100	2009	2013	
BENELLI	125	BN 125	2018	2018	N	DUCATI	1100	STREETFIGHTER 1100 S	2010	2013	N
BENELLI	125	TNT 125	2017	2017	N	DUCATI	1100	STREETFIGHTER 1100	2010	2011	N
BENELLI	250	BN 251	2016	2017	N	DUCATI	1100	1098 R - S	2007	2008	N
BENELLI	300	BN 302	2015	2017	N	DUCATI	1199	PANIGALE 1199	2012	2015	
BENELLI	500	LEONCINO 500 / TRAIL	2017	2019	N	DUCATI	1200	DIAVEL	2011	2015	
BENELLI	500	TRK 502	2017	2019	N	DUCATI	1200	1198 R - S	2009	2011	N
BENELLI	600	BN 600 / 600 GT	2014	2016	N	DUCATI	1299	PANIGALE 1299	2015	2016	
BENELLI	600	BN 600 R	2014	2014	N	DUCATI	800	HYPERMOTARD 796	2008	2012	N
BENELLI	899	TNT 899	2008	2014	N	DUCATI	821	HYPERMOTARD / SP 821	2013	2015	N
BENELLI	900	TRE 899 K	2009	2011	N	DUCATI	821	HYPERSTRADA	2013	2015	N
BENELLI	900	TORNADO TRE	2003	2003	N	DUCATI	1100	HYPERMOTARD 1100 EVO	2010	2012	N
BENELLI	1130	TNT 1130 CENTURY RACER	2011	2014	N	HUSQVARNA	900	NUDA 900	2011	2013	N
BENELLI	1130	TNT 1130 R	2011	2014	N	KAWASAKI	250	ZX 250R	2009	2012	
BENELLI	1130	TNT 1130 R160	2010	2014	N	KAWASAKI	600	ZX6R	2003	2016	N
BENELLI	1130	TRE 1130 K	2007	2012	N	KAWASAKI	636	ZX6R 636	2013	2016	
BENELLI	1130	TRE 1130 K AMAZONAS	2007	2012	N	KAWASAKI	650	ER-6N	2012	2016	
BENELLI	1130	TNT 1130 SPORT EVO	2007	2007	N	KAWASAKI	750	Z750	2004	2012	
BENELLI	1130	TNT 1130 SPORT	2006	2006	N	KAWASAKI	800	Z800	2013	2016	
BENELLI	1130	TNT 1130	2006	2006	N	KAWASAKI	1000	Z1000 SX	2011	2016	
BENELLI	1130	TNT 1130 TITANIUM	2005	2005	N	KAWASAKI	1000	ZX10R	2011	2016	
BMW	1000	S1000 R	2014	2015		KAWASAKI	1000	Z1000	2003	2015	
BMW	1000	S1000 RR	2009	2015		KTM	125	DUKE 125	2011	2016	N
DUCATI	400	MONSTER 400	1995	2001	N	KTM	690	DUKE 690	2012	2017	N
DUCATI	600	MONSTER 600	1994	2001	N	MV AGUSTA	675	F3 675	2011	2019	
DUCATI	620	MONSTER 620	2002	2006	N	MV AGUSTA	675	F3 800	2011	2019	
DUCATI	695	MONSTER 695	2007	2008	N	MV AGUSTA	675	B3 BRUTALE 675	2012	2015	
DUCATI	700	MONSTER 696	2008	2013	N	MV AGUSTA	750	BRUTALE 750	2003	2005	N
DUCATI	748	748 S	2000	2002	N	MV AGUSTA	750	F4 750	1999	2003	N
DUCATI	748	748	1998	2001	N	MV AGUSTA	800	B3 BRUTALE 800	2012	2015	
DUCATI	749	749 R - S	2003	2006	N	MV AGUSTA	910	BRUTALE 910	2005	2008	N
DUCATI	750	750 SS	1999	2002	N	MV AGUSTA	920	BRUTALE 920	2010	2011	N
DUCATI	750	MONSTER 750	1996	1999	N	MV AGUSTA	989	BRUTALE 989 R	2008	2008	N
DUCATI	796	MONSTER 796	2011	2013	N	MV AGUSTA	990	BRUTALE 990 R	2010	2011	N
DUCATI	797	MONSTER 797	2017	2019	N	MV AGUSTA	1000	F4 1000	2004	2018	N
DUCATI	800	MONSTER S4 - ST2	2007	2007		MV AGUSTA	1078	BRUTALE 1078 RR	2008	2008	N
DUCATI	800	MONSTER 800	2003	2004	N	MV AGUSTA	1078	F4 100 CC	2007	2007	N
DUCATI	800	800 SS	2003	2003	N	MV AGUSTA	1090	BRUTALE 1090 - CORSA	2013	2015	N
DUCATI	821	MONSTER 821	2014	2019		MV AGUSTA	1090	BRUTALE 1090R - 1090 RR	2012	2015	N



Marca Brand	CC	Modello Model	Anno dal From	Anno al To	Novità New
MV AGUSTA	1090	BRUTALE 1090 RR	2010	2011	N
SUZUKI	125	GSX-S 125	2018	2020	N
SUZUKI	125	GZ 125 MARAUDER	2008	2010	N
SUZUKI	125	VL 125 INTRUDER	2005	2007	N
SUZUKI	250	GSX 250 R	2017	2020	N
SUZUKI	250	INAZUMA L7	2017	2017	N
SUZUKI	250	INAZUMA	2013	2013	N
SUZUKI	250	VL 250 INTRUDER	2005	2007	N
SUZUKI	250	AN250 BURGMAN	2003	2006	N
SUZUKI	400	AN400 BURGMAN	2003	2019	N
SUZUKI	600	GSX-R 600	2004	2017	N
SUZUKI	600	GSR 600	2006	2011	N
SUZUKI	650	DL 650 V-STROM	2015	2019	N
SUZUKI	650	SV 650	2003	2019	N
SUZUKI	650	AN650 BURGMAN	2006	2018	N
SUZUKI	650	GLADIUS 650	2009	2015	N
SUZUKI	650	GSF 650 BANDIT	2005	2012	N
SUZUKI	650	GSX-F 650	2008	2012	N
SUZUKI	750	GSX-S 750	2018	2019	N
SUZUKI	750	GSR 750	2011	2017	N
SUZUKI	750	GSX-R 750	2004	2017	N
SUZUKI	1000	GSXS 1000	2015	2019	N
SUZUKI	1000	DL 1000 V-STROM	2002	2019	N
SUZUKI	1000	GSXR 1000	2003	2016	N
SUZUKI	1200	GSF 1200 BANDIT	1996	2016	N
SUZUKI	1250	GSX 1250	2010	2016	N
SUZUKI	1300	GSX 1300 B-KING	2008	2010	N
SUZUKI	1400	GSX 1400	2002	2005	N
SUZUKI	1000	SV 1000 S	2003	2012	N
TRIUMPH	675	STREET TRIPLE 675 R.	2007	2015	
YAMAHA	125	R 125	2008	2019	
YAMAHA	125	YP125R X-MAX	2006	2009	N
YAMAHA	250	YP250R X-MAX	2005	2009	N
YAMAHA	250	YP 250 MAYESTY	1996	2003	N
YAMAHA	320	R3	2015	2019	
YAMAHA	400	X-MAX 400	2013	2014	
YAMAHA	400	YP 400 MAYESTY	2004	2011	N
YAMAHA	500	XP 500 T-MAX	2001	2007	N
YAMAHA	530	XP 530 T-MAX	2013	2019	N
YAMAHA	600	R6	2006	2019	
YAMAHA	600	XJ6-N	2010	2015	N
YAMAHA	600	XJ6-S DIVERSION	2009	2015	N
YAMAHA	600	FZ6-S	2007	2008	N
YAMAHA	600	FZ6 FAZER 600	2004	2007	
YAMAHA	600	FZ6-N	2005	2006	N
YAMAHA	600	FZR 600	1989	1993	N
YAMAHA	660	MT-03	2006	2017	N
YAMAHA	700	MT-07	2014	2019	
YAMAHA	700	MTM 690	2018	2019	N
YAMAHA	700	XSR 700	2016	2018	N
YAMAHA	700	MT-07 MOTO CAGE	2014	2014	N
YAMAHA	800	FZ8-N	2011	2015	N

Marca Brand	CC	Modello Model	Anno dal From	Anno al To	Novità New
YAMAHA	850	MT-09	2013	2019	
YAMAHA	850	NIKEN	2018	2019	N
YAMAHA	850	MT-09 TRACER / TRACER 900	2015	2019	N
YAMAHA	850	MT-09 TRACER / TRACER 900	2015	2019	N
YAMAHA	850	TDM 850	1991	2001	N
YAMAHA	850	TDM 850	1991	2001	N
YAMAHA	900	XSR 900	2016	2019	N
YAMAHA	900	TDM 900	2002	2010	
YAMAHA	900	XJ 900 S DIVERSION	1994	2001	N
YAMAHA	1000	R1	1998	2019	
YAMAHA	1000	MT-10	2016	2019	N
YAMAHA	1000	FZ1 FAZER 1000	2001	2012	
YAMAHA	1000	FZ1-N	2006	2011	N
YAMAHA	1000	FZS FAZER 1000	2001	2005	N
YAMAHA	1300	FJR 1300	2006	2018	N
YAMAHA	1300	XJR 1300	2009	2016	N
YAMAHA	1700	V-MAX	2009	2016	N

BRAKE/CLUTCH MASTER CYLINDERS

ACCESSORIES SPARE PARTS

CNC-WORKED FLUID RESERVOIR

FULL CLUTCH

HYDRAULIC-CLUTCH TRANFORMATION KIT

LEVER

THROTTLE CONTROL

BRAKE CALIPER

RACING KIT

BUTTON PANEL

LEVER GUARD

CLIP-ON

STREET RACING REARSET

FUEL CAPS

STEERING NUT

CRASH PADS

PADDOCK STAND

MIRROR COVERS

REAR-VIEW MIRRORS

FOG LIGHTS KIT

HANDLEBARS ACCESSORIES

HANDLEBARS



Codice Reference	Descrizione Description
TK003	Contrappeso con inserto colorato, specifico applicazioni Handlebar end with coloured insert, specific for models

Colori Colours

O 	Y 	B 	R 	S 	G 
arancione orange	oro - gold	blu - blue	rosso - red	argento - silver	verde - green

Nota: questi contrappesi possono essere montati ed adattati su altre moto, con terminale del manubrio / semi-manubrio con filetto M16 x 1,5
 Note: these handlebar ends can be fitted on other motorbikes, with handlebar / clip-on with threaded hole M16 x 1,5

TK003 - Applicazioni / Application list

Marca Brand	CC	Modello Model	Anno dal From	Anno al To	Novità New
YAMAHA	125	R 125	2008	2019	N
YAMAHA	125	YP 125 R X-MAX	2006	2009	N
YAMAHA	250	YP 250 MAYESTY	1996	2003	N
YAMAHA	250	YP 250 R X-MAX	2005	2009	N
YAMAHA	400	X-MAX 400	2013	2014	
YAMAHA	400	YP 400 MAYESTY	2004	2011	N
YAMAHA	500	XP 500 T-MAX	2001	2007	
YAMAHA	530	XP 530 T-MAX	2013	2019	N
YAMAHA	600	FZ6 FAZER 600	2004	2007	
YAMAHA	600	FZR 600	1989	1993	N
YAMAHA	600	XJ6-N	2010	2015	N
YAMAHA	600	XJ6-S DIVERSION	2009	2015	N
YAMAHA	690	MTM 690	2018	2019	N
YAMAHA	700	MT-07	2014	2019	N
YAMAHA	700	MT-07 MOTO CAGE	2014	2014	N
YAMAHA	700	XSR 700	2016	2018	N
YAMAHA	850	MT-09	2013	2019	N
YAMAHA	850	NIKEN	2018	2019	N
YAMAHA	850	TDM 850	1991	2001	
YAMAHA	900	TDM 900	2002	2010	
YAMAHA	900	XJ 900 S DIVERSION	1994	2001	
YAMAHA	900	XSR 900	2016	2019	N
YAMAHA	1000	FZ1 FAZER 1000	2001	2012	
YAMAHA	1000	FZS FAZER 1000	2001	2005	N
YAMAHA	1000	MT-10	2016	2019	N
YAMAHA	1300	XJR 1300	2009	2016	N

BRAKE/CLUTCH
 MASTER CYLINDERS
 ACCESSORIES
 SPARE PARTS
 CNC-WORKED FLUID
 RESERVOIR
 FULL CLUTCH
 HYDRAULIC-CLUTCH
 TRANSFORMATION KIT
 LEVER
 THROTTLE CONTROL
 BRAKE CALIPER
 RACING KIT
 BUTTON PANEL
 LEVER GUARD
 CLIP-ON
 STREET RACING
 REARSET
 FUEL CAPS
 STEERING NUT
 CRASH PADS
 PADDOCK STAND
 MIRROR COVERS
 REAR-VIEW MIRRORS
 FOG LIGHTS KIT
 HANDLEBARS
 ACCESSORIES
 HANDLEBARS

CAVALLOTTI RISERS



Codice Reference	Descrizione Description
RK121	Rialzi + 10 mm per manubrio Ø 22 mm +10 mm-risers for handlebars Ø 22 mm
RK122	Rialzi + 20 mm per manubrio Ø 22 mm +20 mm-risers for handlebars Ø 22 mm

Colori / Colours

N ●
nero - black

S ●
argento - silver

BRAKE/CLUTCH
MASTER CYLINDERS

ACCESSORIES
SPARE PARTS

CNC-WORKED FLUID
RESERVOIR

FULL CLUTCH

HYDRAULIC-CLUTCH
TRANSFORMATION KIT

LEVER

THROTTLE CONTROL

BRAKE CALIPER

RACING KIT

BUTTON PANEL

LEVER GUARD

CLIP-ON

STREET RACING
REARSET

FUEL CAPS

STEERING NUT

CRASH PADS

Paddock STAND

MIRROR COVERS

REAR-VIEW MIRRORS

FOG LIGHTS KIT

HANDLEBARS
ACCESSORIES

HANDLEBARS



RK119-RK120



129X

Codice Reference	Descrizione Description
RK119	Kit cavallotti + 40 mm per manubrio Ø 28 mm +40 mm-riser kit for handlebars Ø 28 mm
RK120	Kit cavallotti + 60 mm per manubrio Ø 28 mm +60 mm-riser kit for handlebars Ø 28 mm
129X	Kit cavallotti + 22 mm per manubrio Ø 22 mm +22 mm-riser kit for handlebars Ø 22 mm

Colori / Colours

N ●
nero - black

S ●
argento - silver



Codice Reference	Descrizione Description
RK118	Kit cavallotti di trasformazione manubrio da Ø 22 a 28 mm Transformation riser-kit for handlebar Ø from 22 to 28 mm
128X	Kit cavallotti di trasformazione +24 mm manubrio da Ø 22 a 28,5 mm +24 mm transformation riser-kit for handlebar Ø from 22 to 28,5 mm
RK123	Kit cavallotti di trasformazione +10 mm manubrio da Ø 28 a 28,5 mm +10 mm transformation riser-kit for handlebar from Ø 28 to 28,5 mm
RK124	Kit cavallotti di trasformazione +20mm manubrio da Ø 28 a Ø 28,5 mm +20 mm transformation riser-kit for handlebar from Ø 28 to Ø 28,5mm

Colori / Colours

N ●
nero - black

S ●
argento - silver

BRAKE/CLUTCH
 MASTER CYLINDERS
 ACCESSORIES
 SPARE PARTS
 CNC-WORKED FLUID
 RESERVOIR
 FULL CLUTCH
 HYDRAULIC-CLUTCH
 TRANSFORMATION KIT
 LEVER
 THROTTLE CONTROL
 BRAKE CALIPER
 RACING KIT
 BUTTON PANEL
 LEVER GUARD
 CLIP-ON
 STREET RACING
 REARSET
 FUEL CAPS
 STEERING NUT
 CRASH PADS
 PADDOCK STAND
 MIRROR COVERS
 REAR-VIEW MIRRORS
 FOG LIGHTS KIT
 HANDLEBARS
 ACCESSORIES
 HANDLEBARS

KIT CAVALLOTTI MANUBRIO

HANDLEBAR RISER KITS

Colori
Colours

N ●
nero - black

S ●
argento - silver



Codice Code	Modello Model
123XN	KIT TRASFORMAZIONE +18mm PER CAVALLOTTI MANUBRIO MOTO FUORI STRADA DA 22MM A 28,5MM, ERGAL CNC, NERO / BLACK STANDARD TRANSFORMATION RISERS KIT FOR OFF-ROAD MOTORCYCLES, FROM 22MM TO 28,5MM, CNC-WORKED ERGAL
123XS	KIT TRASFORMAZIONE +18mm PER CAVALLOTTI MANUBRIO MOTO FUORI STRADA DA 22MM A 28,5MM, ERGAL CNC, ARGENTO / SILVER STANDARD TRANSFORMATION RISERS KIT FOR OFF-ROAD MOTORCYCLES, FROM 22MM TO 28,5MM, CNC-WORKED ERGAL
124X10N	KIT TRASFORMAZIONE +28MM PER CAVALLOTTI MANUBRIO MOTO FUORI STRADA DA 22MM A 28,5MM, ERGAL CNC, NERO / BLACK TRANSFORMATION RISERS KIT +10MM, FOR OFF-ROAD MOTORCYCLES, FROM 22MM TO 28,5MM, CNC-WORKED ERGAL
124X10S	KIT TRASFORMAZIONE +28MM PER CAVALLOTTI MANUBRIO MOTO FUORI STRADA DA 22MM A 28,5MM, ERGAL CNC, ARGENTO / SILVER TRANSFORMATION RISERS KIT +10MM, FOR OFF-ROAD MOTORCYCLES, FROM 22MM TO 28,5MM, CNC-WORKED ERGAL
125X20N	KIT TRASFORMAZIONE +38MM PER CAVALLOTTI MANUBRIO MOTO FUORI STRADA DA 22MM A 28,5MM, ERGAL CNC, NERO / BLACK TRANSFORMATION RISERS KIT +20MM, FOR OFF-ROAD MOTORCYCLES, FROM 22MM TO 28,5MM, CNC-WORKED ERGAL
125X20S	KIT TRASFORMAZIONE +38MM PER CAVALLOTTI MANUBRIO MOTO FUORI STRADA DA 22MM A 28,5MM, ERGAL CNC, ARGENTO / SILVER TRANSFORMATION RISERS KIT +20MM, FOR OFF-ROAD MOTORCYCLES, FROM 22MM TO 28,5MM, CNC-WORKED ERGAL
128XN	KIT TRASFORMAZIONE +24MM PER CAVALLOTTI MANUBRIO MOTO FUORI STRADA DA 22MM A 28,5MM, al 6061t6, nero / black transformations risers kit +24mm for off-road motorcycles, from 22mm to 28,5mm, made in al 6061t6
129XN	KIT cavallotti +22MM PER CAVALLOTTI MANUBRIO MOTO FUORI STRADA Ø 22MM, al 6061t6, nero / black risers kit +22mm for off-road motorcycles, Ø 22mm, made in al 6061t6

BRAKE/CLUTCH
MASTER CYLINDERS
 ACCESSORIES
SPARE PARTS
 CNC-WORKED FLUID
RESERVOIR
 FULL CLUTCH
 HYDRAULIC-CLUTCH
TRANSFORMATION KIT
 LEVER
 THROTTLE CONTROL
 BRAKE CALIPER
 RACING KIT
 BUTTON PANEL
 LEVER GUARD
 CLIP-ON
 STREET RACING
REARSET
 FUEL CAPS
 STEERING NUT
 CRASH PADS
 PADDOCK STAND
 MIRROR COVERS
 REAR-VIEW MIRRORS
 FOG LIGHTS KIT
 HANDLEBARS
ACCESSORIES
 HANDLEBARS

KIT ASSEMBLAGGIO MANUBRI

HANDLEBARS KIT



KIT ASSEMBLAGGIO MANUBRIO 7/8" (22 MM)

7/8" (22 MM) HANDLEBAR ASSEMBLY KIT

Codice Code	Lunghezza Length	Codice Code	Lunghezza Length
A1N	200mm	A7N	290mm
A2N	240mm	A8N	255mm
A3N	280mm	A9N	257mm
A4N	300mm	A10N	305mm
A5N	180mm	A11N	210mm
A6N	270mm	A12N	265mm

Colori / Colours

N ●
nero - black

KIT ASSEMBLAGGIO MANUBRIO FATBAR 1-1/8" (28,6 MM)

1-1/8" (28,6 MM) FATBAR HANDLEBAR ASSEMBLY KIT

Codice Code	Lunghezza Length	Codice Code	Lunghezza Length
B1N	200mm	B7N	290mm
B2N	240mm	B8N	255mm
B3N	280mm	B9N	257mm
B4N	300mm	B10N	305mm
B5N	180mm	B11N	210mm
B6N	270mm	B12N	265mm

Colori / Colours

N ●
nero - black

PARACOLPI PER MANUBRI 7/8" (22 MM) E FATBAR 1-1/8" (28,6 MM)

SPONGY BUFFERS FOR HANDLEBAR 7/8" (22 MM) AND 1-1/8" (28,6 MM) FATBAR

Paracolpi per manubri 7/8" (22mm) Spongy buffers for 7/8" (22mm)	Paracolpi per manubri 1-1/8" (28,6mm) fatbar Spongy buffers for 1-1/8" (28,6mm) fatbar
SH1N	SK1N
SH2R	SK1R
SH4B	SK1B
SH6A	SK1A

Colori / Colours

N ● nero - black **O** ● arancione - orange **R** ● rosso - red **B** ● blu - blue

BRAKE/CLUTCH
MASTER CYLINDERS
ACCESSORIES
SPARE PARTS
CNC-WORKED FLUID
RESERVOIR
FULL CLUTCH
HYDRAULIC-CLUTCH
TRANFORMATION KIT
LEVER
THROTTLE CONTROL
BRAKE CALIPER
RACING KIT
BUTTON PANEL
LEVER GUARD
CLIP-ON
STREET RACING
REARSET
FUEL CAPS
STEERING NUT
CRASH PADS
PADDOCK STAND
MIRROR COVERS
REAR-VIEW MIRRORS
FOG LIGHTS KIT
HANDLEBARS
ACCESSORIES
HANDLEBARS



MANUBRI HANDLEBARS



- BRAKE/CLUTCH MASTER CYLINDERS
- ACCESSORIES SPARE PARTS
- CNC-WORKED FLUID RESERVOIR
- FULL CLUTCH
- HYDRAULIC-CLUTCH TRANSFORMATION KIT
- LEVER
- THROTTLE CONTROL
- BRAKE CALIPER
- RACING KIT
- BUTTON PANEL
- LEVER GUARD
- CLIP-ON
- STREET RACING REARSET
- FUEL CAPS
- STEERING NUT
- CRASH PADS
- PADDOCK STAND
- MIRROR COVERS
- REAR-VIEW MIRRORS
- FOG LIGHTS KIT
- HANDLEBARS ACCESSORIES
- HANDLEBARS

MANUBRI Ø 22 MM

Ø 22 MM HANDLEBARS

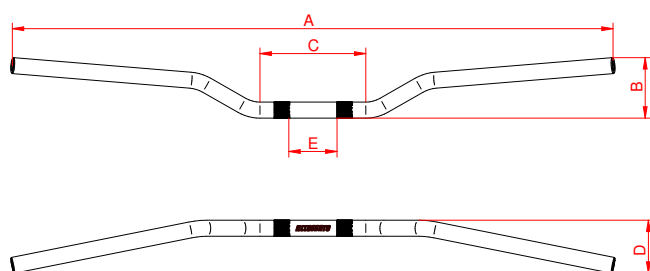

Codice Code	Caratteristiche tecniche Technical details
HB001	<p>Ø 22x5mm A 803mm B 116mm C 159mm D 73mm E 60mm</p> <p>Materiale / Raw material: Alluminio / Aluminium Estremità forate / Perforated ends: No Zigrinatura laterale / Lateral knurling: No Zigrinatura centrale / Central knurling: Sì / Yes</p>

Colori / Colours

N ●	Y ●	O ●	R ●	B ●	G ●	S ●
nero - black	oro - gold	arancione - orange	rosso - red	blu - blue	verde - green	argento - silver

Codice Code	Caratteristiche tecniche Technical details
HB003	<p>Ø 22x5mm A 825mm B 130mm C 100mm D 71mm</p> <p>Materiale / Raw material: Alluminio / Aluminium Estremità forate / Perforated ends: No Zigrinatura laterale / Lateral knurling: No Zigrinatura centrale / Central knurling: Sì / Yes</p>

Colori / Colours

N ●	Y ●	O ●	R ●	B ●	G ●	S ●
nero - black	oro - gold	arancione - orange	rosso - red	blu - blue	verde - green	argento - silver

- BRAKE/CLUTCH MASTER CYLINDERS
- ACCESSORIES SPARE PARTS
- CNC-WORKED FLUID RESERVOIR
- FULL CLUTCH
- HYDRAULIC-CLUTCH TRANSFORMATION KIT
- LEVER
- THROTTLE CONTROL
- BRAKE CALIPER
- RACING KIT
- BUTTON PANEL
- LEVER GUARD
- CLIP-ON
- STREET RACING REARSET
- FUEL CAPS
- STEERING NUT
- CRASH PADS
- PADDOCK STAND
- MIRROR COVERS
- REAR-VIEW MIRRORS
- FOG LIGHTS KIT
- HANDLEBARS ACCESSORIES
- HANDLEBARS

Codice Code	Caratteristiche tecniche Technical details
HB005	Ø 22x5mm A 725mm B 115mm C 164mm D 108mm E 70mm Materiale / Raw material: Alluminio / Aluminium Estremità forate / Perforated ends: No Zigrinatura laterale / Lateral knurling: Sì / Yes Zigrinatura centrale / Central knurling: Sì / Yes

Colori / Colours

N  nero - black
 Y  oro - gold
 O  arancione - orange
 R  rosso - red
 B  blu - blue
 G  verde - green
 S  argento - silver

Codice Code	Caratteristiche tecniche Technical details
HB007	Ø 22x5mm A 810mm B 100mm C 153mm D 99mm E 70mm Materiale / Raw material: Alluminio / Aluminium Estremità forate / Perforated ends: No Zigrinatura laterale / Lateral knurling: No Zigrinatura centrale / Central knurling: Sì / Yes

Colori / Colours

N  nero - black
 Y  oro - gold
 O  arancione - orange
 R  rosso - red
 B  blu - blue
 G  verde - green
 S  argento - silver

Codice Code	Caratteristiche tecniche Technical details
HB009	Ø 22x5mm A 800mm B 92mm C 155mm D 90mm Materiale / Raw material: Alluminio / Aluminium Estremità forate / Perforated ends: No Zigrinatura laterale / Lateral knurling: No Zigrinatura centrale / Central knurling: Sì / Yes

Colori / Colours

N  nero - black
 Y  oro - gold
 O  arancione - orange
 R  rosso - red
 B  blu - blue
 G  verde - green
 S  argento - silver

BRAKE/CLUTCH
 MASTER CYLINDERS
 ACCESSORIES
 SPARE PARTS
 CNC-WORKED FLUID
 RESERVOIR
 FULL CLUTCH
 HYDRAULIC-CLUTCH
 TRANSFORMATION KIT
 LEVER
 THROTTLE CONTROL
 BRAKE CALIPER
 RACING KIT
 BUTTON PANEL
 LEVER GUARD
 CLIP-ON
 STREET RACING
 REARSET
 FUEL CAPS
 STEERING NUT
 CRASH PADS
 PADDOCK STAND
 MIRROR COVERS
 REAR-VIEW MIRRORS
 FOG LIGHTS KIT
 HANDLEBARS
 ACCESSORIES
 HANDLEBARS

Codice Code	Caratteristiche tecniche Technical details
HB011	<p>Ø 22x5mm A 725mm B 122mm C 135mm D 100mm</p> <p>Materiale / Raw material: Alluminio / Aluminium Estremità forate / Perforated ends: No Zigrinatura laterale / Lateral knurling: No Zigrinatura centrale / Central knurling: Si / Yes</p>

Colori / Colours

N ● nero - black
Y ● oro - gold
O ● arancione - orange
R ● rosso - red
B ● blu - blue
G ● verde - green
S ● argento - silver

Codice Code	Caratteristiche tecniche Technical details
HB013	<p>Ø 22x5mm A 820mm B 120mm C 160mm D 110mm</p> <p>Materiale / Raw material: Alluminio / Aluminium Estremità forate / Perforated ends: No Zigrinatura laterale / Lateral knurling: No Zigrinatura centrale / Central knurling: Si / Yes</p>

Colori / Colours

N ● nero - black
Y ● oro - gold
O ● arancione - orange
R ● rosso - red
B ● blu - blue
G ● verde - green
S ● argento - silver

Codice Code	Caratteristiche tecniche Technical details
HB015	<p>Ø 22x5mm A 778mm B 167mm C 150mm D 116mm</p> <p>Materiale / Raw material: Alluminio / Aluminium Estremità forate / Perforated ends: No Zigrinatura laterale / Lateral knurling: Si / Yes Zigrinatura centrale / Central knurling: No</p>

Colori / Colours

N ● nero - black
Y ● oro - gold
O ● arancione - orange
R ● rosso - red
B ● blu - blue
G ● verde - green
S ● argento - silver

BRAKE/CLUTCH
MASTER CYLINDERS
ACCESSORIES
SPARE PARTS
CNC-WORKED FLUID
RESERVOIR
FULL CLUTCH
HYDRAULIC-CLUTCH
TRANSFORMATION KIT
LEVER
THROTTLE CONTROL
BRAKE CALIPER
RACING KIT
BUTTON PANEL
LEVER GUARD
CLIP-ON
STREET RACING
REARSET
FUEL CAPS
STEERING NUT
CRASH PADS
PADDOCK STAND
MIRROR COVERS
REAR-VIEW MIRRORS
FOG LIGHTS KIT
HANDLEBARS
ACCESSORIES
HANDLEBARS

Codice Code	Caratteristiche tecniche Technical details
HB017	Ø 22x5mm A 739mm B 191mm C 123mm D 62mm E 60mm Materiale / Raw material: Alluminio / Aluminium Estremità forate / Perforated ends: No Zigrinatura laterale / Lateral knurling: No Zigrinatura centrale / Central knurling: Si / Yes

Colori / Colours

S ●

argento - silver

Codice Code	Caratteristiche tecniche Technical details
HB021	Ø 22x5mm A 653mm B 126mm C 125mm D 110mm Materiale / Raw material: Alluminio / Aluminium Estremità forate / Perforated ends: No Zigrinatura laterale / Lateral knurling: No Zigrinatura centrale / Central knurling: Si / Yes

Colori / Colours

T ●

titanio - titanium

Codice Code	Caratteristiche tecniche Technical details
HB024	Ø 22x2mm A 777mm B 130mm C 190mm D 95mm Materiale / Raw material: Acciaio / Steel

Colori / Colours

N ●

nero - black

S ●

argento - silver

BRAKE/CLUTCH
MASTER CYLINDERS
ACCESSORIES
SPARE PARTS
CNC-WORKED FLUID
RESERVOIR
FULL CLUTCH
HYDRAULIC-CLUTCH
TRANFORMATION KIT
LEVER
THROTTLE CONTROL
BRAKE CALIPER
RACING KIT
BUTTON PANEL
LEVER GUARD
CLIP-ON
STREET RACING
REARSET
FUEL CAPS
STEERING NUT
CRASH PADS
PADOCK STAND
MIRROR COVERS
REAR-VIEW MIRRORS
FOG LIGHTS KIT
HANDLEBARS
ACCESSORIES
HANDLEBARS

Codice Code	Caratteristiche tecniche Technical details
HB027	Ø 22x2mm A 760mm B 133mm C 128mm D 94mm E 60mm Materiale / Raw material: Acciaio / Steel

Colori / Colours

N ●
nero - black

Codice Code	Caratteristiche tecniche Technical details
HB029	Ø 22x2mm A 760mm B 133mm C 128mm D 94mm E 60mm Materiale / Raw material: Acciaio / Steel

Colori / Colours

N ●
nero - black

Codice Code	Caratteristiche tecniche Technical details
HB045	Ø 22x5mm A 723mm B 122mm C 111mm D 109mm E 70mm Materiale / Raw material: Alluminio / Aluminium Estremità forate / Perforated ends: No Zigrinatura laterale / Lateral knurling: No Zigrinatura centrale / Central knurling: Si / Yes

Colori / Colours

N ● nero - black
Y ● oro - gold
O ● arancione - orange
R ● rosso - red
B ● blu - blue
G ● verde - green
S ● argento - silver
T ● titanio - titanium

BRAKE/CLUTCH
 MASTER CYLINDERS
 ACCESSORIES
 SPARE PARTS
 CNC-WORKED FLUID
 RESERVOIR
 FULL CLUTCH
 HYDRAULIC-CLUTCH
 TRANSFORMATION KIT
 LEVER
 THROTTLE CONTROL
 BRAKE CALIPER
 RACING KIT
 BUTTON PANEL
 LEVER GUARD
 CLIP-ON
 STREET RACING
 REARSET
 FUEL CAPS
 STEERING NUT
 CRASH PADS
 PADDOCK STAND
 MIRROR COVERS
 REAR-VIEW MIRRORS
 FOG LIGHTS KIT
 HANDLEBARS
 ACCESSORIES
 HANDLEBARS

Codice Code	Caratteristiche tecniche Technical details
HB046	Ø 22x5mm A 825mm B 110mm C 114mm D 89mm E 70mm Materiale / Raw material: Alluminio / Aluminium Estremità forate / Perforated ends: No Zigrinatura laterale / Lateral knurling: No Zigrinatura centrale / Central knurling: Si / Yes

Colori / Colours

N ● nero - black
 Y ● oro - gold
 O ● arancione - orange
 R ● rosso - red
 B ● blu - blue
 G ● verde - green
 S ● argento - silver
 T ● titanio - titanium

Codice Code	Caratteristiche tecniche Technical details
HB047	Ø 22x5mm A 814mm B 145mm C 142mm D 69mm E 70mm Materiale / Raw material: Alluminio / Aluminium Estremità forate / Perforated ends: No Zigrinatura laterale / Lateral knurling: No Zigrinatura centrale / Central knurling: Si / Yes

Colori / Colours

N ● nero - black
 Y ● oro - gold
 O ● arancione - orange
 R ● rosso - red
 B ● blu - blue
 G ● verde - green
 S ● argento - silver
 T ● titanio - titanium

Codice Code	Caratteristiche tecniche Technical details
HB051	Ø 22x5mm A 795mm B 117mm C 125mm D 83mm Materiale / Raw material: Alluminio / Aluminium Estremità forate / Perforated ends: No Zigrinatura laterale / Lateral knurling: Si / Yes Zigrinatura centrale / Central knurling: No

Colori / Colours

N ● nero - black
 R ● rosso - red
 S ● argento - silver

BRAKE/CLUTCH
MASTER CYLINDERS
 ACCESSORIES
SPARE PARTS
 CNC-WORKED FLUID
RESERVOIR
 FULL CLUTCH
 HYDRAULIC-CLUTCH
TRANSFORMATION KIT
 LEVER
 THROTTLE CONTROL
 BRAKE CALIPER
 RACING KIT
 BUTTON PANEL
 LEVER GUARD
 CLIP-ON
 STREET RACING
REARSET
 FUEL CAPS
 STEERING NUT
 CRASH PADS
 PADDOCK STAND
 MIRROR COVERS
 REAR-VIEW MIRRORS
 FOG LIGHTS KIT
 HANDLEBARS
ACCESSORIES
 HANDLEBARS

Codice Code	Caratteristiche tecniche Technical details
HB052	Ø 22x5mm A 796mm B 102mm C 137mm D 78mm Materiale / Raw material: Alluminio / Aluminium Estremità forate / Perforated ends: No Zigrinatura laterale / Lateral knurling: Sì / Yes Zigrinatura centrale / Central knurling: No

Colori / Colours

N ● nero - black
 R ● rosso - red
 S ● argento - silver

Codice Code	Caratteristiche tecniche Technical details
HB053	Ø 22x5mm A 796mm B 111mm C 131mm D 79mm Materiale / Raw material: Alluminio / Aluminium Estremità forate / Perforated ends: No Zigrinatura laterale / Lateral knurling: Sì / Yes Zigrinatura centrale / Central knurling: No

Colori / Colours

N ● nero - black
 S ● argento - silver

Codice Code	Caratteristiche tecniche Technical details
HB054	Ø 22x5mm A 790mm B 123mm C 121mm D 94mm Materiale / Raw material: Alluminio / Aluminium Estremità forate / Perforated ends: No Zigrinatura laterale / Lateral knurling: Sì / Yes Zigrinatura centrale / Central knurling: No

Colori / Colours

N ● nero - black
R ● rosso - red
B ● blu - blue
S ● argento - silver

- BRAKE/CLUTCH MASTER CYLINDERS
- ACCESSORIES SPARE PARTS
- CNC-WORKED FLUID RESERVOIR
- FULL CLUTCH
- HYDRAULIC-CLUTCH TRANSFORMATION KIT
- LEVER
- THROTTLE CONTROL
- BRAKE CALIPER
- RACING KIT
- BUTTON PANEL
- LEVER GUARD
- CLIP-ON
- STREET RACING REARSET
- FUEL CAPS
- STEERING NUT
- CRASH PADS
- PADDOCK STAND
- MIRROR COVERS
- REAR-VIEW MIRRORS
- FOG LIGHTS KIT
- HANDLEBARS ACCESSORIES
- HANDLEBARS

Codice Code	Caratteristiche tecniche Technical details
HB055	<p>Ø 22x5mm A 830mm B 152mm C 130mm D 96mm</p> <p>Materiale / Raw material: Alluminio / Aluminium Estremità forate / Perforated ends: No Zigrinatura laterale / Lateral knurling: Si / Yes Zigrinatura centrale / Central knurling: No</p>

Colori / Colours

N ● **S** ●
nero - black argento - silver

Codice Code	Caratteristiche tecniche Technical details
HB056	<p>Ø 22x5mm A 785mm B 99mm C 135mm D 94mm</p> <p>Materiale / Raw material: Alluminio / Aluminium Estremità forate / Perforated ends: No Zigrinatura laterale / Lateral knurling: Si / Yes Zigrinatura centrale / Central knurling: No</p>

Colori / Colours

N ● **S** ●
nero - black argento - silver

Codice Code	Caratteristiche tecniche Technical details
HB057	<p>Ø 22x5mm A 785mm B 105mm C 130mm D 96mm</p> <p>Materiale / Raw material: Alluminio / Aluminium Estremità forate / Perforated ends: No Zigrinatura laterale / Lateral knurling: Si / Yes Zigrinatura centrale / Central knurling: No</p>

Colori / Colours

N ● **R** ● **S** ●
nero - black rosso - red argento - silver

BRAKE/CLUTCH
MASTER CYLINDERS
ACCESSORIES
SPARE PARTS
CNC-WORKED FLUID
RESERVOIR
FULL CLUTCH
HYDRAULIC-CLUTCH
TRANFORMATION KIT
LEVER
THROTTLE CONTROL
BRAKE CALIPER
RACING KIT
BUTTON PANEL
LEVER GUARD
CLIP-ON
STREET RACING
REARSET
FUEL CAPS
STEERING NUT
CRASH PADS
PADOCK STAND
MIRROR COVERS
REAR-VIEW MIRRORS
FOG LIGHTS KIT
HANDLEBARS
ACCESSORIES
HANDLEBARS

Codice Code	Caratteristiche tecniche Technical details
HB058	Ø 22x5mm A 807mm B 132mm C 121mm D 88mm Materiale / Raw material: Alluminio / Aluminium Estremità forate / Perforated ends: No Zigrinatura laterale / Lateral knurling: Sì / Yes Zigrinatura centrale / Central knurling: No

Colori / Colours

N ● nero - black
 R ● rosso - red
 S ● argento - silver

Codice Code	Caratteristiche tecniche Technical details
HB059	Ø 22x5mm A 802mm B 121mm C 136mm D 75mm Materiale / Raw material: Alluminio / Aluminium Estremità forate / Perforated ends: No Zigrinatura laterale / Lateral knurling: Sì / Yes Zigrinatura centrale / Central knurling: No

Colori / Colours

N ● nero - black
 R ● rosso - red
 B ● blu - blue
 G ● verde - green
 S ● argento - silver

Codice Code	Caratteristiche tecniche Technical details
HB060	Ø 22x5mm A 802mm B 141mm C 121mm D 75mm Materiale / Raw material: Alluminio / Aluminium Estremità forate / Perforated ends: No Zigrinatura laterale / Lateral knurling: Sì / Yes Zigrinatura centrale / Central knurling: No

Colori / Colours

N ● nero - black
 S ● argento - silver

- BRAKE/CLUTCH MASTER CYLINDERS
- ACCESSORIES SPARE PARTS
- CNC-WORKED FLUID RESERVOIR
- FULL CLUTCH
- HYDRAULIC-CLUTCH TRANSFORMATION KIT
- LEVER
- THROTTLE CONTROL
- BRAKE CALIPER
- RACING KIT
- BUTTON PANEL
- LEVER GUARD
- CLIP-ON
- STREET RACING REARSET
- FUEL CAPS
- STEERING NUT
- CRASH PADS
- PADDOCK STAND
- MIRROR COVERS
- REAR-VIEW MIRRORS
- FOG LIGHTS KIT
- HANDLEBARS ACCESSORIES
- HANDLEBARS

Codice Code	Caratteristiche tecniche Technical details
HB061	<p>Ø 22x5mm A 803mm B 114mm C 135mm D 78mm</p> <p>Materiale / Raw material: Alluminio / Aluminium Estremità forate / Perforated ends: No Zigrinatura laterale / Lateral knurling: Si / Yes Zigrinatura centrale / Central knurling: No</p>

Colori / Colours

N  nero - black
 R  rosso - red
 B  blu - blue
 S  argento - silver



Codice Code	Caratteristiche tecniche Technical details
HB062	<p>Ø 22x5mm A 790mm B 104mm C 130mm D 94mm</p> <p>Materiale / Raw material: Alluminio / Aluminium Estremità forate / Perforated ends: No Zigrinatura laterale / Lateral knurling: Si / Yes Zigrinatura centrale / Central knurling: No</p>

Colori / Colours

N  nero - black
 R  rosso - red
 S  argento - silver

Codice Code	Caratteristiche tecniche Technical details
HB063	<p>Ø 22x5mm A 800mm B 93mm C 135mm D 86mm</p> <p>Materiale / Raw material: Alluminio / Aluminium Estremità forate / Perforated ends: No Zigrinatura laterale / Lateral knurling: Si / Yes Zigrinatura centrale / Central knurling: No</p>

Colori / Colours

N  nero - black
 S  argento - silver

BRAKE/CLUTCH
MASTER CYLINDERS
 ACCESSORIES
SPARE PARTS
 CNC-WORKED FLUID
RESERVOIR
 FULL CLUTCH
 HYDRAULIC-CLUTCH
TRANFORMATION KIT
 LEVER
 THROTTLE CONTROL
 BRAKE CALIPER
 RACING KIT
 BUTTON PANEL
 LEVER GUARD
 CLIP-ON
 STREET RACING
REARSET
 FUEL CAPS
 STEERING NUT
 CRASH PADS
 Paddock STAND
 MIRROR COVERS
 REAR-VIEW MIRRORS
 FOG LIGHTS KIT
 HANDLEBARS
ACCESSORIES
 HANDLEBARS

Codice Code	Caratteristiche tecniche Technical details
HB064	Ø 22x5mm A 805mm B 115mm C 141mm D 76mm Materiale / Raw material: Alluminio / Aluminium Estremità forate / Perforated ends: No Zigrinatura laterale / Lateral knurling: Sì / Yes Zigrinatura centrale / Central knurling: No

Colori / Colours

N ● **S** ●
 nero - black argento - silver

Codice Code	Caratteristiche tecniche Technical details
HB066	Ø 22x5mm A 840mm B 140mm C 141mm D 99mm Materiale / Raw material: Alluminio / Aluminium Estremità forate / Perforated ends: No Zigrinatura laterale / Lateral knurling: Sì / Yes Zigrinatura centrale / Central knurling: No

Colori / Colours

N ● **S** ●
 nero - black argento - silver

Codice Code	Caratteristiche tecniche Technical details
HB067	Ø 22x5mm A 780mm B 128mm C 106mm D 109mm Materiale / Raw material: Alluminio / Aluminium Estremità forate / Perforated ends: No Zigrinatura laterale / Lateral knurling: Sì / Yes Zigrinatura centrale / Central knurling: No

Colori / Colours

N ● **B** ● **S** ●
 nero - black blu - blue argento - silver

- BRAKE/CLUTCH MASTER CYLINDERS
- ACCESSORIES SPARE PARTS
- CNC-WORKED FLUID RESERVOIR
- FULL CLUTCH
- HYDRAULIC-CLUTCH TRANSFORMATION KIT
- LEVER
- THROTTLE CONTROL
- BRAKE CALIPER
- RACING KIT
- BUTTON PANEL
- LEVER GUARD
- CLIP-ON
- STREET RACING REARSET
- FUEL CAPS
- STEERING NUT
- CRASH PADS
- PADDOCK STAND
- MIRROR COVERS
- REAR-VIEW MIRRORS
- FOG LIGHTS KIT
- HANDLEBARS ACCESSORIES
- HANDLEBARS

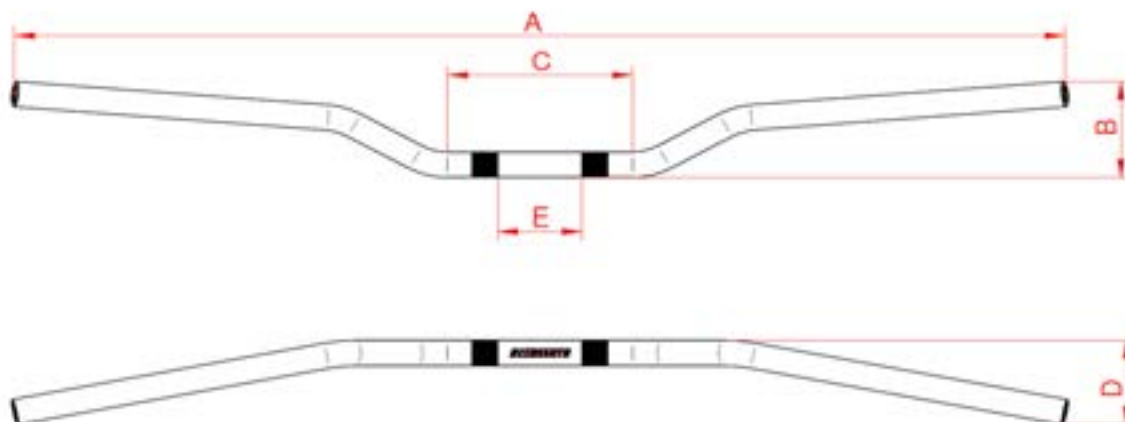

Codice
Reference

Caratteristiche tecniche
Technical details

Colore
Colour

HB150

Ø 22mm - 7/8"
A 755mm
B 133mm
C 145mm
D 101mm
E 66mm
Materiale / Raw material: Acciaio / Steel



●
cromato - chromed

Codice
Reference

Caratteristiche tecniche
Technical details

HB151

Ø 22mm - 7/8"
A 755mm
B 133mm
C 145mm
D 101mm
E 66mm
Materiale / Raw material: Acciaio / Steel



Colori / Colours

VB ●
blu - blue

VR ●
rosso - red

VY ●
giallo fluo
fluorescent yellow

VG ●
verde fluo
fluorescent green

VRF ●
rosso fluo
fluorescent red

VN ●
nero - black

- BRAKE/CLUTCH MASTER CYLINDERS
- ACCESSORIES SPARE PARTS
- CNC-WORKED FLUID RESERVOIR
- FULL CLUTCH
- HYDRAULIC-CLUTCH TRANFORMATION KIT
- LEVER
- THROTTLE CONTROL
- BRAKE CALIPER
- RACING KIT
- BUTTON PANEL
- LEVER GUARD
- CLIP-ON
- STREET RACING REARSET
- FUEL CAPS
- STEERING NUT
- CRASH PADS
- PADDOCK STAND
- MIRROR COVERS
- REAR-VIEW MIRRORS
- FOG LIGHTS KIT
- HANDLEBARS ACCESSORIES
- HANDLEBARS

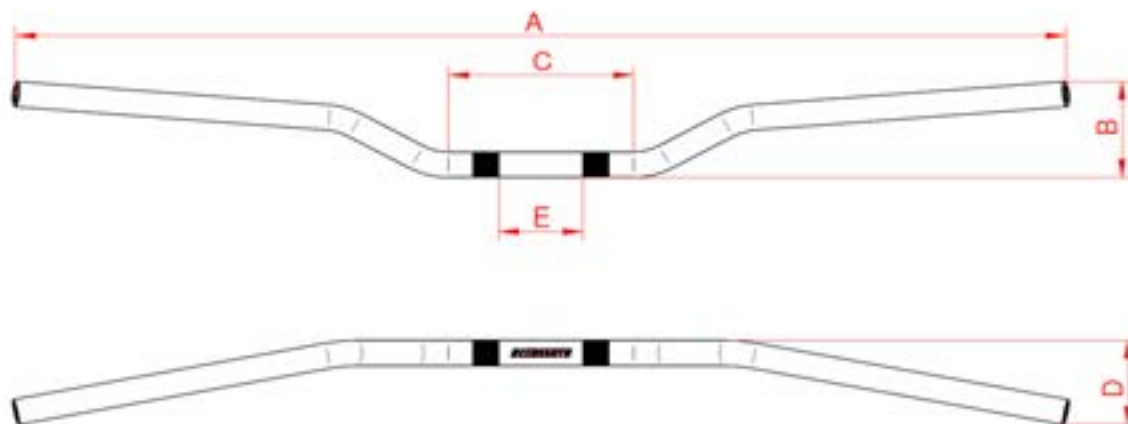

Codice Reference	Caratteristiche tecniche Technical details	Colori Colours
HB153	<p>Ø 22mm - 7/8"</p> <p>A 700mm</p> <p>B 0mm</p> <p>C 193mm</p> <p>D 89mm</p> <p>E 76mm</p> <p>Materiale / Raw material: Acciaio / Steel</p>	<p>cromato - chromed</p>
HB154	<p>Ø 22mm - 7/8"</p> <p>A 744mm</p> <p>B 78mm</p> <p>C 124mm</p> <p>D 098mm</p> <p>E 60mm</p> <p>Materiale / Raw material: Acciaio / Steel</p>	<p>cromato - chromed</p>
HB155	<p>Ø 22mm - 7/8"</p> <p>A 806mm</p> <p>B 186mm</p> <p>C 136mm</p> <p>D 121mm</p> <p>E 60mm</p> <p>Materiale / Raw material: Acciaio / Steel</p>	<p>cromato - chromed</p>

- BRAKE/CLUTCH MASTER CYLINDERS
- ACCESSORIES SPARE PARTS
- CNC-WORKED FLUID RESERVOIR
- FULL CLUTCH
- HYDRAULIC-CLUTCH TRANFORMATION KIT
- LEVER
- THROTTLE CONTROL
- BRAKE CALIPER
- RACING KIT
- BUTTON PANEL
- LEVER GUARD
- CLIP-ON
- STREET RACING REARSET
- FUEL CAPS
- STEERING NUT
- CRASH PADS
- PADDOCK STAND
- MIRROR COVERS
- REAR-VIEW MIRRORS
- FOG LIGHTS KIT
- HANDLEBARS ACCESSORIES
- HANDLEBARS

Codice Reference	Caratteristiche tecniche Technical details	Colori Colours
HB156	<p>Ø 22mm - 7/8"</p> <p>A 750mm B 132mm C 130mm D 113mm E N.P</p> <p>Materiale / Raw material: Acciaio / Steel</p>	<p>● cromato - chromed</p>



Codice Reference	Caratteristiche tecniche Technical details	Colori Colours
HB157	<p>Ø 22mm - 7/8"</p> <p>A 716mm B 130mm C 13mm D 227mm E 60mm</p> <p>Materiale / Raw material: Acciaio / Steel</p>	<p>● cromato - chromed</p>







Codice Reference	Caratteristiche tecniche Technical details	Colori Colours
HB158	<p>Ø 22mm - 7/8"</p> <p>A 746mm B 45mm C 100mm D 107mm E 55mm</p> <p>Materiale / Raw material: Acciaio / Steel</p>	<p>● cromato - chromed</p>

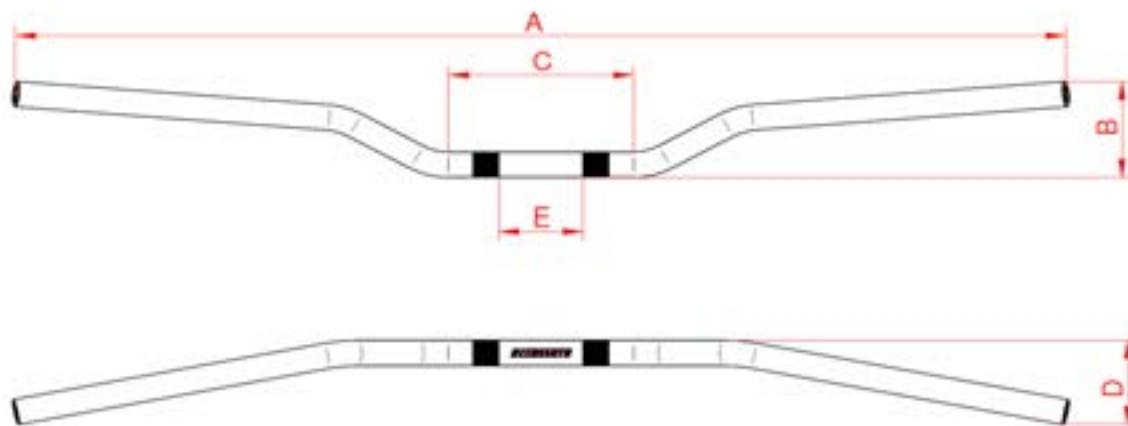







- BRAKE/CLUTCH MASTER CYLINDERS
- ACCESSORIES SPARE PARTS
- CNC-WORKED FLUID RESERVOIR
- FULL CLUTCH
- HYDRAULIC-CLUTCH TRANSFORMATION KIT
- LEVER
- THROTTLE CONTROL
- BRAKE CALIPER
- RACING KIT
- BUTTON PANEL
- LEVER GUARD
- CLIP-ON
- STREET RACING REARSET
- FUEL CAPS
- STEERING NUT
- CRASH PADS
- Paddock STAND
- MIRROR COVERS
- REAR-VIEW MIRRORS
- FOG LIGHTS KIT
- HANDLEBARS ACCESSORIES
- HANDLEBARS



Codice Reference	Caratteristiche tecniche Technical details	Colori Colours
HB159	Ø 22mm - 7/8" A 675mm B 126mm C 118mm D 92mm E 65mm Materiale / Raw material: Acciaio / Steel	 cromato - chromed
HB160	Ø 22mm - 7/8" A 675mm B 106mm C 127mm D 91mm E 65mm Materiale / Raw material: Acciaio / Steel	 cromato - chromed
HB161	Ø 22mm - 7/8" A 675mm B 91mm C 130mm D 91mm E 65mm Materiale / Raw material: Acciaio / Steel	 cromato - chromed
HB162	Ø 22mm - 7/8" A 750mm B 131mm C 146mm D 112mm E 66mm Materiale / Raw material: Acciaio / Steel	 cromato - chromed

- BRAKE/CLUTCH MASTER CYLINDERS
- ACCESSORIES SPARE PARTS
- CNC-WORKED FLUID RESERVOIR
- FULL CLUTCH
- HYDRAULIC-CLUTCH TRANSFORMATION KIT
- LEVER
- THROTTLE CONTROL
- BRAKE CALIPER
- RACING KIT
- BUTTON PANEL
- LEVER GUARD
- CLIP-ON
- STREET RACING REARSET
- FUEL CAPS
- STEERING NUT
- CRASH PADS
- PADOCK STAND
- MIRROR COVERS
- REAR-VIEW MIRRORS
- FOG LIGHTS KIT
- HANDLEBARS ACCESSORIES
- HANDLEBARS

Codice Reference	Caratteristiche tecniche Technical details		Colori Colours
HB163	Ø 22mm - 7/8" A 750mm B 131mm C 146mm D 112mm E 66mm Materiale / Raw material: Acciaio / Steel		 nero - black
HB164	Ø 22mm - 7/8" A 722mm B 63mm C 164mm D 122mm E 60mm Materiale / Raw material: Acciaio / Steel		 cromato - chromed
HB165	Ø 22mm - 7/8" A 669mm B 98mm C 100mm D 122mm E 60mm Materiale / Raw material: Acciaio / Steel		 cromato - chromed
HB166	Ø 22mm - 7/8" A 669mm B 78mm C 105mm D 122mm E 60mm Materiale / Raw material: Acciaio / Steel		 cromato - chromed

- BRAKE/CLUTCH MASTER CYLINDERS
- ACCESSORIES SPARE PARTS
- CNC-WORKED FLUID RESERVOIR
- FULL CLUTCH
- HYDRAULIC-CLUTCH TRANFORMATION KIT
- LEVER
- THROTTLE CONTROL
- BRAKE CALIPER
- RACING KIT
- BUTTON PANEL
- LEVER GUARD
- CLIP-ON
- STREET RACING REARSET
- FUEL CAPS
- STEERING NUT
- CRASH PADS
- PADDOCK STAND
- MIRROR COVERS
- REAR-VIEW MIRRORS
- FOG LIGHTS KIT
- HANDLEBARS ACCESSORIES
- HANDLEBARS

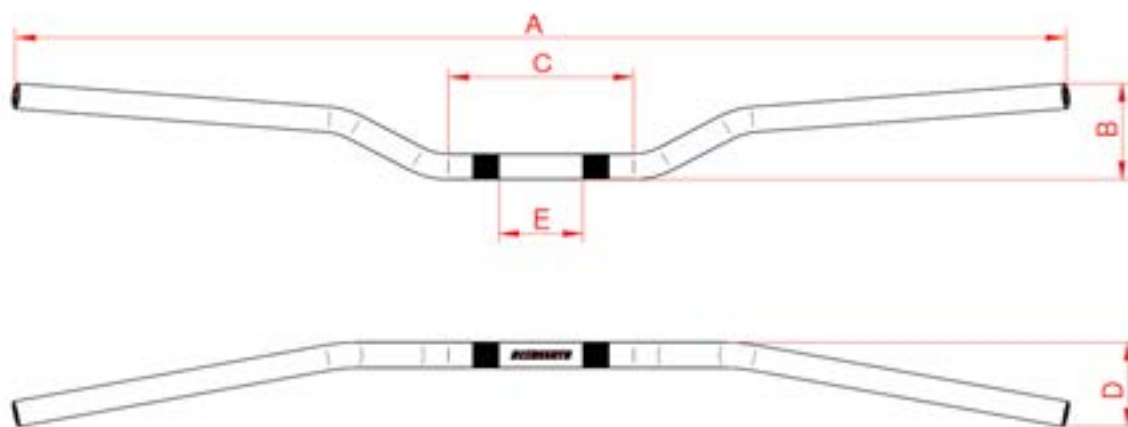

Codice
Reference

Caratteristiche tecniche
Technical details

HB152

Ø 22mm - 7/8"
A 755mm
B 134mm
C 146mm
D 102mm

Materiale / Raw material: Alluminio / Aluminium



Colori verniciati / Painted colours

VB 
blu - blue

VR 
rosso - red

VY 
giallo fluo
fluorescent yellow

VG 
verde fluo
fluorescent green

VRF 
rosso fluo
fluorescent red

VN 
nero - black

Colori ossidato / Oxidized colours

N 
nero - black

O 
arancione
orange

Y 
oro - gold

B 
blu - blue

R 
rosso - red

S 
argento - silver

G 
verde - green

BRAKE/CLUTCH
MASTER CYLINDERS

ACCESSORIES
SPARE PARTS

CNC-WORKED FLUID
RESERVOIR

FULL CLUTCH

HYDRAULIC-CLUTCH
TRANFORMATION KIT

LEVER

THROTTLE CONTROL

BRAKE CALIPER

RACING KIT

BUTTON PANEL

LEVER GUARD

CLIP-ON

STREET RACING
REARSET

FUEL CAPS

STEERING NUT

CRASH PADS

PADDOCK STAND

MIRROR COVERS

REAR-VIEW MIRRORS

FOG LIGHTS KIT

HANDLEBARS
ACCESSORIES

HANDLEBARS

Codice | **Caratteristiche tecniche**
Reference | Technical details







HB167	Ø 22mm - 7/8"
	A 823mm
	B 83mm
	C 145mm
	D 73mm
	E 66mm
Materiale / Raw material: Alluminio / Aluminium	



Colori ossidato / Oxidized colours

N  nero - black	O  arancione orange	Y  oro - gold	B  blu - blue	R  rosso - red	S  argento - silver	G  verde - green	T  titanio - titanium
---	---	---	---	---	---	--	---

Colori verniciati / Painted colours







VB  blu - blue	VR  rosso - red	VY  giallo fluo fluorescent yellow	VG  verde fluo fluorescent green	VRF  rosso fluo fluorescent red	VN  nero - black
---	--	---	---	--	---

Codice | **Caratteristiche tecniche**
Reference | Technical details

HB169	Ø 22mm - 7/8"
	A 726mm
	B 90mm
	C 80mm
	D 119mm
	E 47mm
Materiale / Raw material: Alluminio / Aluminium	



Colori / Colours

N  nero - black	O  arancione orange	Y  oro - gold	B  blu - blue	R  rosso - red	S  argento - silver	G  verde - green
---	---	---	---	--	---	--

Codice | **Caratteristiche tecniche**
Reference | Technical details

HB170	Ø 22mm - 7/8"
	A 726mm
	B 138mm
	C 80mm
	D 91mm
	E 47mm
Materiale / Raw material: Alluminio / Aluminium	



Colori / Colours

N  nero - black	O  arancione orange	Y  oro - gold	B  blu - blue	R  rosso - red	S  argento - silver	G  verde - green
---	---	---	---	--	---	--

- BRAKE/CLUTCH MASTER CYLINDERS
- ACCESSORIES SPARE PARTS
- CNC-WORKED FLUID RESERVOIR
- FULL CLUTCH
- HYDRAULIC-CLUTCH TRANSFORMATION KIT
- LEVER
- THROTTLE CONTROL
- BRAKE CALIPER
- RACING KIT
- BUTTON PANEL
- LEVER GUARD
- CLIP-ON
- STREET RACING REARSET
- FUEL CAPS
- STEERING NUT
- CRASH PADS
- Paddock STAND
- MIRROR COVERS
- REAR-VIEW MIRRORS
- FOG LIGHTS KIT
- HANDLEBARS ACCESSORIES
- HANDLEBARS

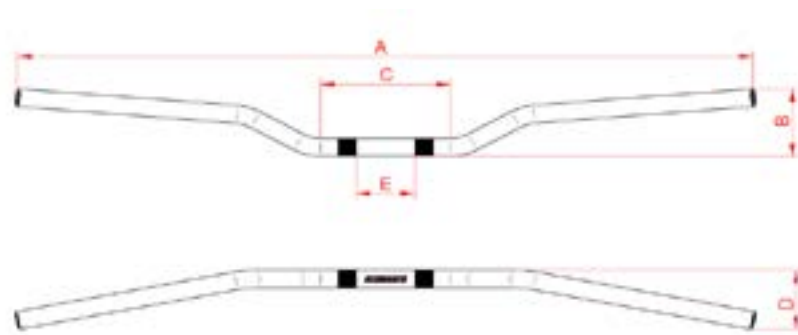

Codice
Reference

Caratteristiche tecniche
Technical details

HB171	Ø 22mm - 7/8" A 750mm B 70mm C 105mm D 109mm E 60mm Materiale / Raw material: Alluminio / Aluminium
-------	---



Colori / Colours

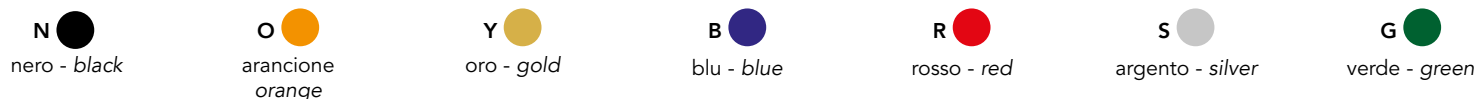

Codice
Reference

Caratteristiche tecniche
Technical details

HB172	Ø 22mm - 7/8" A 692mm B 131mm C 114mm D 131mm E 60mm Materiale / Raw material: Alluminio / Aluminium
-------	--



Colori / Colours



Codice
Reference

Caratteristiche tecniche
Technical details

HB174	Ø 22mm - 7/8" A 861mm B 101mm C 170mm D 88mm E N.P. Materiale / Raw material: Alluminio / Aluminium
-------	---



Colori / Colours



- BRAKE/CLUTCH MASTER CYLINDERS
- ACCESSORIES SPARE PARTS
- CNC-WORKED FLUID RESERVOIR
- FULL CLUTCH
- HYDRAULIC-CLUTCH TRANFORMATION KIT
- LEVER
- THROTTLE CONTROL
- BRAKE CALIPER
- RACING KIT
- BUTTON PANEL
- LEVER GUARD
- CLIP-ON
- STREET RACING REARSET
- FUEL CAPS
- STEERING NUT
- CRASH PADS
- Paddock STAND
- MIRROR COVERS
- REAR-VIEW MIRRORS
- FOG LIGHTS KIT
- HANDLEBARS ACCESSORIES
- HANDLEBARS

Codice **Caratteristiche tecniche**
Reference *Technical details*

HB175	Ø 22mm - 7/8"
	A 750mm
	B 131mm
	C 146mm
	D 109mm
	E 66
Materiale / Raw material: Alluminio / Aluminium	



Colori ossidato / Oxidized colours

N ● nero - black	O ● arancione orange	Y ● oro - gold	B ● blu - blue	R ● rosso - red	S ● argento - silver	G ● verde - green
----------------------------	-----------------------------------	--------------------------	--------------------------	---------------------------	--------------------------------	-----------------------------

Colori verniciati / Painted colours

VB ● blu - blue	VR ● rosso - red	YY ● giallo fluo fluorescent yellow	VG ● verde fluo fluorescent green	VRF ● rosso fluo fluorescent red	VN ● nero - black
---------------------------	----------------------------	--	--	---	-----------------------------

Codice **Caratteristiche tecniche**
Reference *Technical details*

HB177	Ø 22mm
	A 820mm
	B 67mm
	C 140mm
	D 96mm
Materiale / Raw material: Alluminio / Aluminium	



Colori / Colours

N ● nero - black	G ● verde - green	Y ● oro - gold	R ● rosso - red
----------------------------	-----------------------------	--------------------------	---------------------------

Codice **Caratteristiche tecniche**
Reference *Technical details*

HB178	Ø 22mm
	A 820mm
	B 82mm
	C 140mm
	D 96mm
Materiale / Raw material: Alluminio / Aluminium	



Colori / Colours

N ● nero - black	G ● verde - green	Y ● oro - gold	R ● rosso - red
----------------------------	-----------------------------	--------------------------	---------------------------

BRAKE/CLUTCH
MASTER CYLINDERS
ACCESSORIES
SPARE PARTS
CNC-WORKED FLUID
RESERVOIR
FULL CLUTCH
HYDRAULIC-CLUTCH
TRANFORMATION KIT
LEVER
THROTTLE CONTROL
BRAKE CALIPER
RACING KIT
BUTTON PANEL
LEVER GUARD
CLIP-ON
STREET RACING
REARSET
FUEL CAPS
STEERING NUT
CRASH PADS
PADDOCK STAND
MIRROR COVERS
REAR-VIEW MIRRORS
FOG LIGHTS KIT
HANDLEBARS
ACCESSORIES
HANDLEBARS

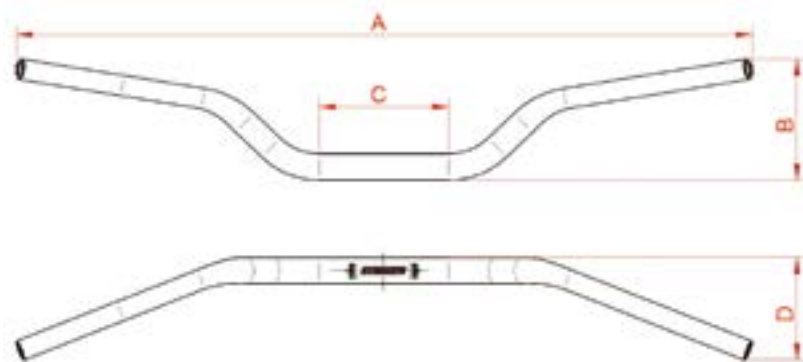

Codice
Reference

Caratteristiche tecniche
Technical details

HB179

Ø 22mm
A 742mm
B 92mm
C 132mm
D 86mm
E 66mm
Materiale / Raw material: Alluminio / Aluminium



Colori / Colours

N ●
nero - black

G ●
verde - green

Y ●
oro - gold

R ●
rosso - red

Codice
Reference

Caratteristiche tecniche
Technical details

HB180

Ø 22mm
A 780mm
B 175mm
C 143mm
D 97mm
E 66mm
Materiale / Raw material: Alluminio / Aluminium



Colori / Colours

N ●
nero - black

G ●
verde - green

Y ●
oro - gold

R ●
rosso - red

BRAKE/CLUTCH
MASTER CYLINDERS

ACCESSORIES
SPARE PARTS

CNC-WORKED FLUID
RESERVOIR

FULL CLUTCH

HYDRAULIC-CLUTCH
TRANSFORMATION KIT

LEVER

THROTTLE CONTROL

BRAKE CALIPER

RACING KIT

BUTTON PANEL

LEVER GUARD

CLIP-ON

STREET RACING
REARSET

FUEL CAPS

STEERING NUT

CRASH PADS

PADDOCK STAND

MIRROR COVERS

REAR-VIEW MIRRORS

FOG LIGHTS KIT

HANDLEBARS
ACCESSORIES

HANDLEBARS

■ MANUBRIO ALLUMINIO Ø28mm / Ø 28mm aluminium handlebar

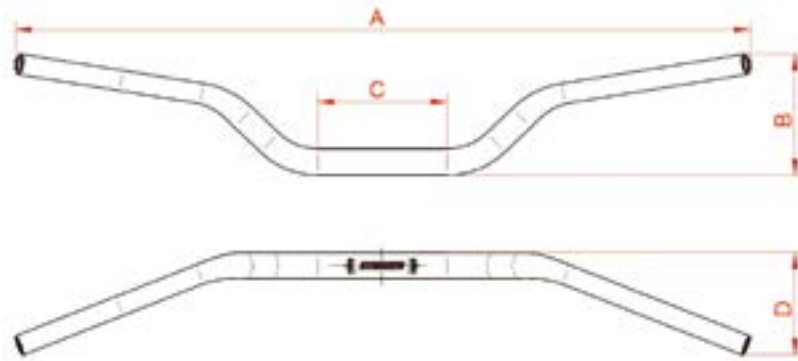

Codice
Reference

Caratteristiche tecniche
Technical details

HB173	Ø 28mm A 735mm B 96mm C 105mm D 130mm E N.P. Materiale / Raw material: Alluminio / Aluminium
-------	--



Colori / Colours

N ●	O ●	Y ●	B ●	R ●	S ●	G ●
nero - black	arancione orange	oro - gold	blu - blue	rosso - red	argento - silver	verde - green

Codice
Reference

Caratteristiche tecniche
Technical details

HB181	Ø 28,5mm A 750mm B 132mm C 121mm D 112mm E N.P. Materiale / Raw material: Alluminio / Aluminium
-------	---



Colori / Colours

N ●	O ●	Y ●	R ●
nero - black	arancione orange	oro - gold	rosso - red

Codice
Reference

Caratteristiche tecniche
Technical details

HB183	Ø 28,5mm A 742mm B 95mm C 121mm D 89mm E N.P. Materiale / Raw material: Alluminio / Aluminium
-------	---



Colori / Colours

N ●	O ●	Y ●	R ●
nero - black	arancione orange	oro - gold	rosso - red

BRAKE/CLUTCH
 MASTER CYLINDERS
 ACCESSORIES
 SPARE PARTS
 CNC-WORKED FLUID
 RESERVOIR
 FULL CLUTCH
 HYDRAULIC-CLUTCH
 TRANSFORMATION KIT
 LEVER
 THROTTLE CONTROL
 BRAKE CALIPER
 RACING KIT
 BUTTON PANEL
 LEVER GUARD
 CLIP-ON
 STREET RACING
 REARSET
 FUEL CAPS
 STEERING NUT
 CRASH PADS
 PADDOCK STAND
 MIRROR COVERS
 REAR-VIEW MIRRORS
 FOG LIGHTS KIT
 HANDLEBARS
 ACCESSORIES
 HANDLEBARS

MANUBRI Ø 28 MM

Ø 28 MM HANDLEBARS

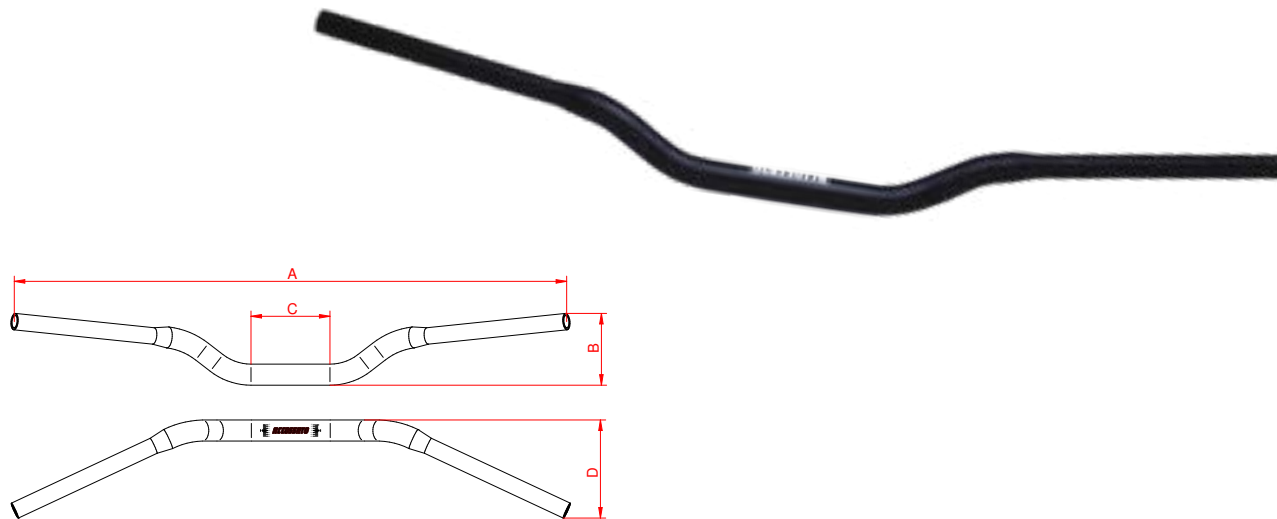

Codice Code	Caratteristiche tecniche Technical details
HB030	<p>Ø 28x4mm A 810mm B 119mm C 144mm D 76mm</p> <p>Materiale / Raw material: Alluminio / Aluminium Estremità forate / Perforated ends: Si / Yes Zigrinatura laterale / Lateral knurling: No Zigrinatura centrale / Central knurling: No</p>

Colori / Colours

N ●	Y ●	O ●	R ●	B ●	G ●	S ●
nero - black	oro - gold	arancione - orange	rosso - red	blu - blue	verde - green	argento - silver

Codice Code	Caratteristiche tecniche Technical details
HB032	<p>Ø 28x4mm A 808mm B 100mm C 139mm D 75mm</p> <p>Materiale / Raw material: Alluminio / Aluminium Estremità forate / Perforated ends: Si / Yes Zigrinatura laterale / Lateral knurling: No Zigrinatura centrale / Central knurling: No</p>

Colori / Colours

N ●	Y ●	O ●	R ●	B ●	G ●	S ●	T ●
nero - black	oro - gold	arancione - orange	rosso - red	blu - blue	verde - green	argento - silver	titanio - titanium

BRAKE/CLUTCH
 MASTER CYLINDERS
 ACCESSORIES
 SPARE PARTS
 CNC-WORKED FLUID
 RESERVOIR
 FULL CLUTCH
 HYDRAULIC-CLUTCH
 TRANSFORMATION KIT
 LEVER
 THROTTLE CONTROL
 BRAKE CALIPER
 RACING KIT
 BUTTON PANEL
 LEVER GUARD
 CLIP-ON
 STREET RACING
 REARSET
 FUEL CAPS
 STEERING NUT
 CRASH PADS
 PADDOCK STAND
 MIRROR COVERS
 REAR-VIEW MIRRORS
 FOG LIGHTS KIT
 HANDLEBARS
 ACCESSORIES
 HANDLEBARS

Codice Code	Caratteristiche tecniche Technical details
HB034	<p>Ø 28x4mm A 772mm B 151mm C 103mm D 146mm</p> <p>Materiale / Raw material: Alluminio / Aluminium Estremità forate / Perforated ends: Sì / Yes Zigrinatura laterale / Lateral knurling: No Zigrinatura centrale / Central knurling: No</p>

Colori / Colours

N 	Y 	O 	R 	B 	V 	S 	T 
nero - black	oro - gold	arancione - orange	rosso - red	blu - blue	verde - green	argento - silver	titanio - titanium

Codice Code	Caratteristiche tecniche Technical details
HB036	<p>Ø 28x4mm A 820mm B 124mm C 72mm D 115mm</p> <p>Materiale / Raw material: Alluminio / Aluminium Estremità forate / Perforated ends: Sì / Yes Zigrinatura laterale / Lateral knurling: No Zigrinatura centrale / Central knurling: No</p>

Colori / Colours

N 	Y 	O 	R 	B 	G 	S 
nero - black	oro - gold	arancione - orange	rosso - red	blu - blue	verde - green	argento - silver

BRAKE/CLUTCH
MASTER CYLINDERS
 ACCESSORIES
SPARE PARTS
 CNC-WORKED FLUID
RESERVOIR
 FULL CLUTCH
 HYDRAULIC-CLUTCH
TRANSFORMATION KIT
 LEVER
 THROTTLE CONTROL
 BRAKE CALIPER
 RACING KIT
 BUTTON PANEL
 LEVER GUARD
 CLIP-ON
 STREET RACING
REARSET
 FUEL CAPS
 STEERING NUT
 CRASH PADS
 PADDOCK STAND
 MIRROR COVERS
 REAR-VIEW MIRRORS
 FOG LIGHTS KIT
 HANDLEBARS
ACCESSORIES
 HANDLEBARS

MANUBRI Ø 28,5 MM

Ø 28,5 MM HANDLEBARS

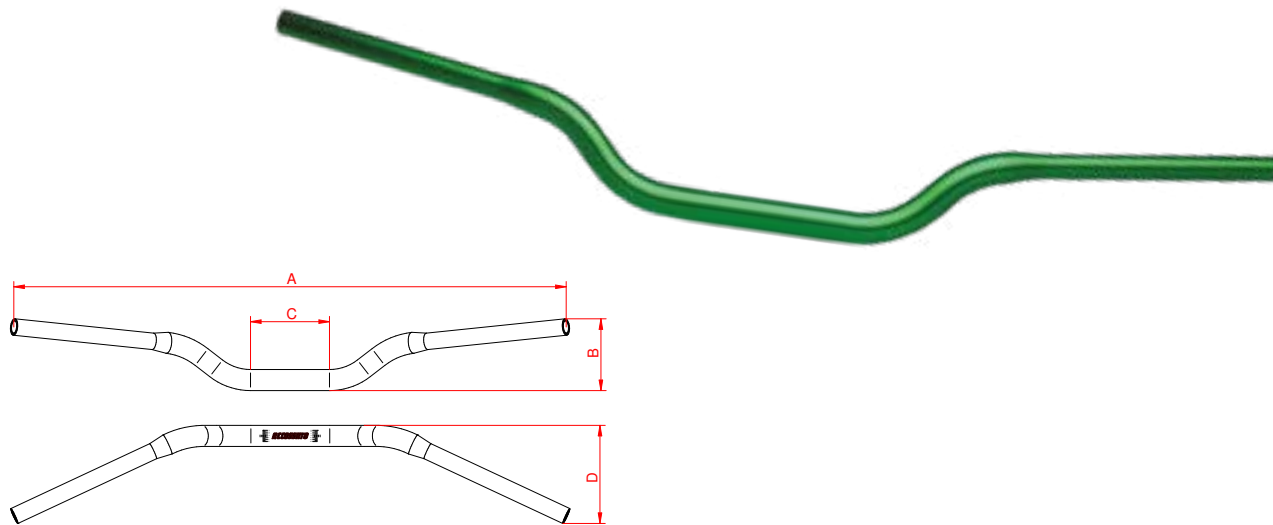

Codice Code	Caratteristiche tecniche Technical details
HB019	<p>Ø 28,5x4,5mm A 752mm B 167mm C 112mm D 81mm</p> <p>Materiale / Raw material: Alluminio / Aluminium Estremità forate / Perforated ends: Si / Yes Zigrinatura laterale / Lateral knurling: No Zigrinatura centrale / Central knurling: No</p>

Colori / Colours



Codice Code	Caratteristiche tecniche Technical details
HB038	<p>Ø 28,5x4,5mm A 802mm B 131mm C 155mm D 78mm</p> <p>Materiale / Raw material: Alluminio / Aluminium Estremità forate / Perforated ends: Si / Yes Zigrinatura laterale / Lateral knurling: No Zigrinatura centrale / Central knurling: No</p>

Colori / Colours



- BRAKE/CLUTCH MASTER CYLINDERS
- ACCESSORIES SPARE PARTS
- CNC-WORKED FLUID RESERVOIR
- FULL CLUTCH
- HYDRAULIC-CLUTCH TRANFORMATION KIT
- LEVER
- THROTTLE CONTROL
- BRAKE CALIPER
- RACING KIT
- BUTTON PANEL
- LEVER GUARD
- CLIP-ON
- STREET RACING REARSET
- FUEL CAPS
- STEERING NUT
- CRASH PADS
- PADDOCK STAND
- MIRROR COVERS
- REAR-VIEW MIRRORS
- FOG LIGHTS KIT
- HANDLEBARS ACCESSORIES
- HANDLEBARS

Codice Code	Caratteristiche tecniche Technical details
HB040	<p>Ø 28,5x4,5mm A 801mm B 128mm C 129mm D 79mm</p> <p>Materiale / Raw material: Alluminio / Aluminium Estremità forate / Perforated ends: Sì / Yes Zigrinatura laterale / Lateral knurling: No Zigrinatura centrale / Central knurling: No</p>

Colori / Colours

N 	Y 	O 	R 	B 	G 	S 
nero - black	oro - gold	arancione - orange	rosso - red	blu - blue	verde - green	argento - silver

Codice Code	Caratteristiche tecniche Technical details
HB041	<p>Ø 28,5x4,5mm A 812mm B 108mm C 140mm D 62mm</p> <p>Materiale / Raw material: Alluminio / Aluminium Estremità forate / Perforated ends: Sì / Yes Zigrinatura laterale / Lateral knurling: No Zigrinatura centrale / Central knurling: No</p>

Colori / Colours

N 	Y 	O 	R 	B 	G 	S 
nero - black	oro - gold	arancione - orange	rosso - red	blu - blue	verde - green	argento - silver

Codice Code	Caratteristiche tecniche Technical details
HB043	<p>Ø 28,5x4,5mm A 756mm B 120mm C 120mm D 113mm</p> <p>Materiale / Raw material: Alluminio / Aluminium Estremità forate / Perforated ends: Sì / Yes Zigrinatura laterale / Lateral knurling: No Zigrinatura centrale / Central knurling: No</p>

Colori / Colours

N 	Y 	O 	R 	B 	G 	S 
nero - black	oro - gold	arancione - orange	rosso - red	blu - blue	verde - green	argento - silver

BRAKE/CLUTCH
MASTER CYLINDERS
 ACCESSORIES
SPARE PARTS
 CNC-WORKED FLUID
RESERVOIR
 FULL CLUTCH
 HYDRAULIC-CLUTCH
TRANSFORMATION KIT
 LEVER
 THROTTLE CONTROL
 BRAKE CALIPER
 RACING KIT
 BUTTON PANEL
 LEVER GUARD
 CLIP-ON
 STREET RACING
REARSET
 FUEL CAPS
 STEERING NUT
 CRASH PADS
 PADDOCK STAND
 MIRROR COVERS
 REAR-VIEW MIRRORS
 FOG LIGHTS KIT
 HANDLEBARS
ACCESSORIES
 HANDLEBARS

Codice Code	Caratteristiche tecniche Technical details
HB068	<p>Ø 28,5x4,5mm A 795mm B 115mm C 126mm D 87mm</p> <p>Materiale / Raw material: Alluminio / Aluminium Estremità forate / Perforated ends: Si / Yes Zigrinatura laterale / Lateral knurling: Si / Yes Zigrinatura centrale / Central knurling: No</p>

Colori / Colours

N ● **B** ●
nero - black blu - blue

Codice Code	Caratteristiche tecniche Technical details
HB069	<p>Ø 28,5x4,5mm A 803mm B 117mm C 100mm D 81mm</p> <p>Materiale / Raw material: Alluminio / Aluminium Estremità forate / Perforated ends: Si / Yes Zigrinatura laterale / Lateral knurling: Si / Yes Zigrinatura centrale / Central knurling: No</p>

Colori / Colours

N ● **R** ● **B** ●
nero - black rosso - red blu - blue

Codice Code	Caratteristiche tecniche Technical details
HB070	<p>Ø 28,5x4,5mm A 802mm B 124mm C 106mm D 79mm</p> <p>Materiale / Raw material: Alluminio / Aluminium Estremità forate / Perforated ends: Si / Yes Zigrinatura laterale / Lateral knurling: Si / Yes Zigrinatura centrale / Central knurling: No</p>

Colori / Colours

N ● **O** ● **R** ● **B** ● **G** ●
nero - black arancione - orange rosso - red blu - blue verde - green

- BRAKE/CLUTCH MASTER CYLINDERS
- ACCESSORIES SPARE PARTS
- CNC-WORKED FLUID RESERVOIR
- FULL CLUTCH
- HYDRAULIC-CLUTCH TRANSFORMATION KIT
- LEVER
- THROTTLE CONTROL
- BRAKE CALIPER
- RACING KIT
- BUTTON PANEL
- LEVER GUARD
- CLIP-ON
- STREET RACING REARSET
- FUEL CAPS
- STEERING NUT
- CRASH PADS
- PADDOCK STAND
- MIRROR COVERS
- REAR-VIEW MIRRORS
- FOG LIGHTS KIT
- HANDLEBARS ACCESSORIES
- HANDLEBARS

Codice Code	Caratteristiche tecniche Technical details
HB071	<p>Ø 28,5x4,5mm A 795mm B 120mm C 116mm D 86mm</p> <p>Materiale / Raw material: Alluminio / Aluminium Estremità forate / Perforated ends: Si / Yes Zigrinatura laterale / Lateral knurling: Si / Yes Zigrinatura centrale / Central knurling: No</p>

Colori / Colours

N ● **R** ● **B** ●
nero - black rosso - red blu - blue

Codice Code	Caratteristiche tecniche Technical details
HB072	<p>Ø 28,5x4,5mm A 802mm B 144mm C 106mm D 79mm</p> <p>Materiale / Raw material: Alluminio / Aluminium Estremità forate / Perforated ends: Si / Yes Zigrinatura laterale / Lateral knurling: Si / Yes Zigrinatura centrale / Central knurling: No</p>

Colori / Colours

N ● **O** ● **R** ● **B** ● **G** ●
nero - black arancione - orange rosso - red blu - blue verde - green

Codice Code	Caratteristiche tecniche Technical details
HB073	<p>Ø 28,5x4,5mm A 740mm B 143mm C 85mm D 67mm</p> <p>Materiale / Raw material: Alluminio / Aluminium Estremità forate / Perforated ends: Si / Yes Zigrinatura laterale / Lateral knurling: Si / Yes Zigrinatura centrale / Central knurling: No</p>

Colori / Colours

N ● **O** ●
nero - black arancione - orange

BRAKE/CLUTCH
MASTER CYLINDERS
ACCESSORIES
SPARE PARTS
CNC-WORKED FLUID
RESERVOIR
FULL CLUTCH
HYDRAULIC-CLUTCH
TRANSFORMATION KIT
LEVER
THROTTLE CONTROL
BRAKE CALIPER
RACING KIT
BUTTON PANEL
LEVER GUARD
CLIP-ON
STREET RACING
REARSET
FUEL CAPS
STEERING NUT
CRASH PADS
Paddock STAND
MIRROR COVERS
REAR-VIEW MIRRORS
FOG LIGHTS KIT
HANDLEBARS
ACCESSORIES
HANDLEBARS

Codice Code	Caratteristiche tecniche Technical details
HB074	<p>Ø 28,5x4,5mm A 796mm B 105mm C 125mm D 81mm</p> <p>Materiale / Raw material: Alluminio / Aluminium Estremità forate / Perforated ends: Si / Yes Zigrinatura laterale / Lateral knurling: Si / Yes Zigrinatura centrale / Central knurling: No</p>

Colori / Colours

N ●
nero - black

Codice Code	Caratteristiche tecniche Technical details
HB075	<p>Ø 28,5x4,5mm A 780mm B 124mm C 115mm D 79mm</p> <p>Materiale / Raw material: Alluminio / Aluminium Estremità forate / Perforated ends: Si / Yes Zigrinatura laterale / Lateral knurling: Si / Yes Zigrinatura centrale / Central knurling: No</p>

Colori / Colours

N ●
nero - black

Codice Code	Caratteristiche tecniche Technical details
HB076	<p>Ø 28,5x4,5mm A 769mm B 121mm C 120mm D 96mm</p> <p>Materiale / Raw material: Alluminio / Aluminium Estremità forate / Perforated ends: Si / Yes Zigrinatura laterale / Lateral knurling: Si / Yes Zigrinatura centrale / Central knurling: No</p>

Colori / Colours

N ●
nero - black

- BRAKE/CLUTCH MASTER CYLINDERS
- ACCESSORIES SPARE PARTS
- CNC-WORKED FLUID RESERVOIR
- FULL CLUTCH
- HYDRAULIC-CLUTCH TRANSFORMATION KIT
- LEVER
- THROTTLE CONTROL
- BRAKE CALIPER
- RACING KIT
- BUTTON PANEL
- LEVER GUARD
- CLIP-ON
- STREET RACING REARSET
- FUEL CAPS
- STEERING NUT
- CRASH PADS
- PADDOCK STAND
- MIRROR COVERS
- REAR-VIEW MIRRORS
- FOG LIGHTS KIT
- HANDLEBARS ACCESSORIES
- HANDLEBARS

Codice Code	Caratteristiche tecniche Technical details
HB077	<p>Ø 28,5x4,5mm A 784mm B 130mm C 140mm D 110mm</p> <p>Materiale / Raw material: Alluminio / Aluminium Estremità forate / Perforated ends: Si / Yes Zigrinatura laterale / Lateral knurling: Si / Yes Zigrinatura centrale / Central knurling: No</p>

Colori / Colours

N ●
nero - black

Codice Code	Caratteristiche tecniche Technical details
HB078	<p>Ø 28,5x4,5mm A 805mm B 108mm C 150mm D 79mm</p> <p>Materiale / Raw material: Alluminio / Aluminium Estremità forate / Perforated ends: Si / Yes Zigrinatura laterale / Lateral knurling: Si / Yes Zigrinatura centrale / Central knurling: No</p>

Colori / Colours

N ●
nero - black

Codice Code	Caratteristiche tecniche Technical details
HB079	<p>Ø 28,5x4,5mm A 806mm B 109mm C 140mm D 66mm</p> <p>Materiale / Raw material: Alluminio / Aluminium Estremità forate / Perforated ends: Si / Yes Zigrinatura laterale / Lateral knurling: Si / Yes Zigrinatura centrale / Central knurling: No</p>

Colori / Colours

N ●
nero - black

- BRAKE/CLUTCH MASTER CYLINDERS
- ACCESSORIES SPARE PARTS
- CNC-WORKED FLUID RESERVOIR
- FULL CLUTCH
- HYDRAULIC-CLUTCH TRANSFORMATION KIT
- LEVER
- THROTTLE CONTROL
- BRAKE CALIPER
- RACING KIT
- BUTTON PANEL
- LEVER GUARD
- CLIP-ON
- STREET RACING REARSET
- FUEL CAPS
- STEERING NUT
- CRASH PADS
- Paddock STAND
- MIRROR COVERS
- REAR-VIEW MIRRORS
- FOG LIGHTS KIT
- HANDLEBARS ACCESSORIES
- HANDLEBARS

Codice Code	Caratteristiche tecniche Technical details
HB080	<p>Ø 28,5x4,5mm A 805mm B 120mm C 130mm D 67mm</p> <p>Materiale / Raw material: Alluminio / Aluminium Estremità forate / Perforated ends: Si / Yes Zigrinatura laterale / Lateral knurling: Si / Yes Zigrinatura centrale / Central knurling: No</p>

Colori / Colours

N ●
nero - black

Codice Code	Caratteristiche tecniche Technical details
HB081	<p>Ø 28,5x4,5mm A 811mm B 117mm C 118mm D 77mm</p> <p>Materiale / Raw material: Alluminio / Aluminium Estremità forate / Perforated ends: Si / Yes Zigrinatura laterale / Lateral knurling: Si / Yes Zigrinatura centrale / Central knurling: No</p>

Colori / Colours

N ● **O** ● **B** ●
nero - black arancione - orange blu - blue

Codice Code	Caratteristiche tecniche Technical details
HB082	<p>Ø 28,5x4,5mm A 779mm B 113mm C 122mm D 75mm</p> <p>Materiale / Raw material: Alluminio / Aluminium Estremità forate / Perforated ends: Si / Yes Zigrinatura laterale / Lateral knurling: Si / Yes Zigrinatura centrale / Central knurling: No</p>

Colori / Colours

N ● **O** ●
nero - black arancione - orange

BRAKE/CLUTCH
MASTER CYLINDERS
 ACCESSORIES
SPARE PARTS
 CNC-WORKED FLUID
RESERVOIR
 FULL CLUTCH
 HYDRAULIC-CLUTCH
TRANFORMATION KIT
 LEVER
 THROTTLE CONTROL
 BRAKE CALIPER
 RACING KIT
 BUTTON PANEL
 LEVER GUARD
 CLIP-ON
 STREET RACING
REARSET
 FUEL CAPS
 STEERING NUT
 CRASH PADS
 PADDOCK STAND
 MIRROR COVERS
 REAR-VIEW MIRRORS
 FOG LIGHTS KIT
 HANDLEBARS
ACCESSORIES
 HANDLEBARS

Codice Code	Caratteristiche tecniche Technical details
HB083	<p>Ø 28,5x4,5mm A 804mm B 130mm C 135mm D 79mm</p> <p>Materiale / Raw material: Alluminio / Aluminium Estremità forate / Perforated ends: Si / Yes Zigrinatura laterale / Lateral knurling: Si / Yes Zigrinatura centrale / Central knurling: No</p>

Colori / Colours

N ●
nero - black

Codice Code	Caratteristiche tecniche Technical details
HB084	<p>Ø 28,5x4,5mm A 811mm B 118mm C 140mm D 74mm</p> <p>Materiale / Raw material: Alluminio / Aluminium Estremità forate / Perforated ends: Si / Yes Zigrinatura laterale / Lateral knurling: Si / Yes Zigrinatura centrale / Central knurling: No</p>

Colori / Colours

N ●
nero - black

BRAKE/CLUTCH
MASTER CYLINDERS

ACCESSORIES
SPARE PARTS

CNC-WORKED FLUID
RESERVOIR

FULL CLUTCH

HYDRAULIC-CLUTCH
TRANFORMATION KIT

LEVER

THROTTLE CONTROL

BRAKE CALIPER

RACING KIT

BUTTON PANEL

LEVER GUARD

CLIP-ON

STREET RACING
REARSET

FUEL CAPS

STEERING NUT

CRASH PADS

PADDOCK STAND

MIRROR COVERS

REAR-VIEW MIRRORS

FOG LIGHTS KIT

HANDLEBARS
ACCESSORIES

HANDLEBARS

APPLICAZIONI MANUBRI

HANDLEBARS APPLICATION LIST

Marca Brand	CC	Modello Model	Dal From	Al To	Codice Code	Novità New	Marca Brand	CC	Modello Model	Dal From	Al To	Codice Code	Novità New
APRILIA	650	PEGASO 650	1992	2000	HB150		APRILIA	1000	CAPO NORD	2001	2007	HB183	NEW
APRILIA	650	MOTO 6.5	1995	1999	HB150		APRILIA	1200	DORSODURO 1200	2010	2015	HB181	
APRILIA	650	MOTO 6.5	1995	1999	HB151		APRILIA	1200	DORSODURO 1200	2010	2015	HB183	NEW
APRILIA	650	PEGASO 650	1992	1996	HB151		APRILIA	ALL	TUONO	2002	2016	HB173	
APRILIA	650	PEGASO 650	1997	2000	HB151		BENELLI	900	TNT 899S	2008	2009	HB181	
APRILIA	650	MOTO 6.5	1995	1999	HB152		BENELLI	900	TREK 899	2009	2011	HB181	
APRILIA	650	PEGASO 650	1992	1996	HB152		BENELLI	900	TNT 899S	2008	2009	HB183	NEW
APRILIA	650	PEGASO 650	1997	2000	HB152		BENELLI	900	TREK 899	2009	2011	HB183	NEW
APRILIA	650	PEGASO 650	1992	1996	HB162		BENELLI	1130	TNT 1130/SPORT EVO/TITAN.	2005	2007	HB181	
APRILIA	650	PEGASO 650	1997	2000	HB162		BENELLI	1130	1130/AMAZONAS	2007	2008	HB181	
APRILIA	650	PEGASO 650	1992	1996	HB163		BENELLI	1130	TNT R 160	2010	2014	HB181	
APRILIA	650	PEGASO 650	1997	2000	HB163		BENELLI	1130	TNT 1130/SPORT EVO/TITAN.	2005	2007	HB183	NEW
APRILIA	650	PEGASO 650	1992	1996	HB167		BENELLI	1130	1130/AMAZONAS	2007	2008	HB183	NEW
APRILIA	650	PEGASO 650	1997	2000	HB167		BENELLI	1130	TNT R 160	2010	2014	HB183	NEW
APRILIA	650	PEGASO 650	1992	1996	HB174		BENELLI	ALL	TNT	2004	2014	HB173	
APRILIA	650	PEGASO 650	1997	2000	HB174		BIMOTA	1100	DELIRIO	2011	2013	HB173	
APRILIA	650	PEGASO 650	1992	1996	HB175		BIMOTA	1100	DB6 / DB6R EVO	2011	2013	HB181	
APRILIA	650	PEGASO 650	1997	2000	HB175		BIMOTA	1100	DB6 / DB6R EVO	2011	2013	HB183	NEW
APRILIA	650	PEGASO 650	1992	1996	HB179	NEW	BMW	100	R 100 CS	1980	1984	HB150	
APRILIA	650	PEGASO 650	1997	2000	HB179	NEW	BMW	100	R 100 CS	1980	1984	HB151	
APRILIA	650	MOTO 6.5	1995	1999	HB180	NEW	BMW	100	R 100 CS	1980	1984	HB152	
APRILIA	650	PEGASO 650	1992	1996	HB180	NEW	BMW	100	R 100 CS	1980	1984	HB162	
APRILIA	650	PEGASO 650	1997	2000	HB180	NEW	BMW	100	R 100 CS	1980	1984	HB163	
APRILIA	650	PEGASO 650 I.E.	2001	2004	HB180	NEW	BMW	100	R 100 CS	1980	1984	HB174	
APRILIA	660	PEGASO 650 STRADA	2005	2009	HB181		BMW	100	R 100 CS	1980	1984	HB175	
APRILIA	660	PEGASO 650 STRADA	2005	2009	HB183	NEW	BMW	100	R 100 CS	1980	1984	HB179	NEW
APRILIA	750	SL 750 SHIVER/GT	2007	2016	HB181		BMW	100	R 100 CS	1980	1984	HB180	NEW
APRILIA	750	SMV 750 DORSODURO	2008	2013	HB181		BMW	100	S 1000 R	2009	2016	HB181	
APRILIA	750	SL 750 SHIVER/GT	2007	2016	HB183	NEW	BMW	100	S 1000 R	2009	2016	HB183	NEW
APRILIA	750	SMV 750 DORSODURO	2008	2013	HB183	NEW	BMW	650	F 650 GS / PARIS DAKAR	2003	2007	HB150	
APRILIA	850	NA 850 MANA/GT	2007	2016	HB150		BMW	650	F 650 GS / PARIS DAKAR	1999	2007	HB150	
APRILIA	850	NA 850 MANA/GT	2007	2016	HB151		BMW	650	F 650 CS	2000	2005	HB150	
APRILIA	850	NA 850 MANA/GT	2007	2016	HB152		BMW	650	F 650 CS	2002	2005	HB150	
APRILIA	850	NA 850 MANA/GT	2007	2016	HB162		BMW	650	F 650 / ST	1996	2000	HB150	
APRILIA	850	NA 850 MANA/GT	2007	2016	HB163		BMW	650	F 650 / ST	1996	2000	HB151	
APRILIA	850	NA 850 MANA/GT	2007	2016	HB167		BMW	650	F 650 CS	2000	2005	HB151	
APRILIA	850	NA 850 MANA/GT	2007	2016	HB174		BMW	650	F 650 CS	2002	2005	HB151	
APRILIA	850	NA 850 MANA/GT	2007	2016	HB175		BMW	650	F 650 GS / PARIS DAKAR	2003	2007	HB151	
APRILIA	850	NA 850 MANA/GT	2007	2016	HB179	NEW	BMW	650	F 650 GS / PARIS DAKAR	1999	2007	HB151	
APRILIA	850	NA 850 MANA/GT	2007	2016	HB180	NEW	BMW	650	F 650 / ST	1996	2000	HB152	
APRILIA	1000	ETV 1000 CAPO NORD	2001	2007	HB150		BMW	650	F 650 CS	2000	2005	HB152	
APRILIA	1000	ETV 1000 CAPO NORD	2001	2007	HB151		BMW	650	F 650 CS	2002	2005	HB152	
APRILIA	1000	ETV 1000 CAPO NORD	2001	2007	HB152		BMW	650	F 650 GS / PARIS DAKAR	2003	2007	HB152	
APRILIA	1000	ETV 1000 CAPO NORD	2001	2007	HB162		BMW	650	F 650 GS / PARIS DAKAR	1999	2007	HB152	
APRILIA	1000	ETV 1000 CAPO NORD	2001	2007	HB163		BMW	650	F 650 / ST	1996	2000	HB162	
APRILIA	1000	ETV 1000 CAPO NORD	2001	2007	HB167		BMW	650	F 650 CS	2000	2005	HB162	
APRILIA	1000	ETV 1000 CAPO NORD	2001	2007	HB174		BMW	650	F 650 CS	2002	2005	HB162	
APRILIA	1000	ETV 1000 CAPO NORD	2001	2007	HB175		BMW	650	F 650 GS / PARIS DAKAR	2003	2007	HB162	
APRILIA	1000	ETV 1000 CAPO NORD	2001	2007	HB179	NEW	BMW	650	F 650 GS / PARIS DAKAR	1999	2007	HB162	
APRILIA	1000	ETV 1000 CAPO NORD	2001	2007	HB180	NEW	BMW	650	F 650 / ST	1996	2000	HB163	
APRILIA	1000	RSV 1000 TUONO	2002	2005	HB181		BMW	650	F 650 CS	2000	2005	HB163	
APRILIA	1000	TUONO 1000 R/FACTORY	2006	2009	HB181		BMW	650	F 650 CS	2002	2005	HB163	
APRILIA	1000	TUONO V4 R / APRC	2011	2014	HB181		BMW	650	F 650 GS / PARIS DAKAR	2003	2007	HB163	
APRILIA	1000	CAPO NORD	2001	2007	HB181		BMW	650	F 650 GS / PARIS DAKAR	1999	2007	HB163	
APRILIA	1000	RSV 1000 TUONO	2002	2005	HB183	NEW	BMW	650	F 650 / ST	1996	2000	HB174	
APRILIA	1000	TUONO 1000 R/FACTORY	2006	2009	HB183	NEW	BMW	650	F 650 CS	2000	2005	HB174	
APRILIA	1000	TUONO V4 R / APRC	2011	2014	HB183	NEW	BMW	650	F 650 CS	2002	2005	HB174	

- BRAKE/CLUTCH MASTER CYLINDERS
- ACCESSORIES SPARE PARTS
- CNC-WORKED FLUID RESERVOIR
- FULL CLUTCH
- HYDRAULIC-CLUTCH TRANFORMATION KIT
- LEVER
- THROTTLE CONTROL
- BRAKE CALIPER
- RACING KIT
- BUTTON PANEL
- LEVER GUARD
- CLIP-ON
- STREET RACING REARSET
- FUEL CAPS
- STEERING NUT
- CRASH PADS
- PADDOCK STAND
- MIRROR COVERS
- REAR-VIEW MIRRORS
- FOG LIGHTS KIT
- HANDLEBARS ACCESSORIES
- HANDLEBARS

Marca Brand	CC	Modello Model	Dal From	Al To	Codice Code	Novità New	Marca Brand	CC	Modello Model	Dal From	Al To	Codice Code	Novità New
BMW	650	F 650 GS / PARIS DAKAR	2003	2007	HB174		BMW	850	R 850 R	1994	2002	HB175	
BMW	650	F 650 GS / PARIS DAKAR	1999	2007	HB174		BMW	850	R 850 R	1994	2002	HB175	
BMW	650	F 650 / ST	1996	2000	HB175		BMW	850	R 850 R	1994	2002	HB175	
BMW	650	F 650 CS	2000	2005	HB175		BMW	850	R 850 R	1994	2002	HB179	NEW
BMW	650	F 650 CS	2002	2005	HB175		BMW	850	R 850 R	1994	2002	HB179	NEW
BMW	650	F 650 GS / PARIS DAKAR	2003	2007	HB175		BMW	850	R 850 R	1994	2002	HB179	NEW
BMW	650	F 650 GS / PARIS DAKAR	1999	2007	HB175		BMW	850	R 850 R	1994	2002	HB180	NEW
BMW	650	F 650 / ST	1996	2000	HB179	NEW	BMW	850	R 850 R	1994	2002	HB180	NEW
BMW	650	F 650 CS	2000	2005	HB179	NEW	BMW	850	R 850 R	1994	2002	HB180	NEW
BMW	650	F 650 CS	2002	2005	HB179	NEW	BMW	1100	R 1100 R	1993	2001	HB150	
BMW	650	F 650 GS / PARIS DAKAR	2003	2007	HB179	NEW	BMW	1100	R 1100 R	1993	2001	HB150	
BMW	650	F 650 GS / PARIS DAKAR	1999	2007	HB179	NEW	BMW	1100	R 1100 R	1993	2001	HB151	
BMW	650	F 650 / ST	1996	2000	HB180	NEW	BMW	1100	R 1100 R	1993	2001	HB151	
BMW	650	F 650 CS	2000	2005	HB180	NEW	BMW	1100	R 1100 R	1993	2001	HB152	
BMW	650	F 650 CS	2002	2005	HB180	NEW	BMW	1100	R 1100 R	1993	2001	HB152	
BMW	650	F 650 GS / PARIS DAKAR	2003	2007	HB180	NEW	BMW	1100	R1100 S	1998	2004	HB156	
BMW	650	F 650 GS / PARIS DAKAR	1999	2007	HB180	NEW	BMW	1100	R1100 S	2005	2006	HB156	
BMW	800	F 800 ST	2006	2012	HB150		BMW	1100	R1100 S BOXER CUP REPLICA	2003	2004	HB156	
BMW	800	F 650 GS	2007	2011	HB150		BMW	1100	R1100 S BOXER CUP REPLICA	2005	2006	HB156	
BMW	800	F 650 GS	2007	2011	HB151		BMW	1100	R 1100 R	1993	2001	HB162	
BMW	800	F 800 ST	2006	2012	HB151		BMW	1100	R 1100 R	1993	2001	HB162	
BMW	800	F 650 GS	2007	2011	HB152		BMW	1100	R 1100 R	1993	2001	HB163	
BMW	800	F 800 ST	2006	2012	HB152		BMW	1100	R 1100 R	1993	2001	HB163	
BMW	800	F 650 GS	2007	2011	HB162		BMW	1100	R 1100 R	1993	2001	HB174	
BMW	800	F 800 ST	2006	2012	HB162		BMW	1100	R 1100 R	1993	2001	HB174	
BMW	800	F 650 GS	2007	2011	HB163		BMW	1100	R 1100 R	1993	2001	HB175	
BMW	800	F 800 ST	2006	2012	HB163		BMW	1100	R 1100 R	1993	2001	HB175	NEW
BMW	800	F 650 GS	2007	2011	HB174		BMW	1100	R 1100 R	1993	2001	HB179	NEW
BMW	800	F 650 GS	2007	2011	HB175		BMW	1100	R 1100 R	1993	2001	HB179	NEW
BMW	800	F 800 ST	2006	2012	HB175		BMW	1100	R 1100 R	1993	2001	HB180	NEW
BMW	800	F 650 GS	2007	2011	HB179	NEW	BMW	1100	R 1100 R	1993	2001	HB180	NEW
BMW	800	F 800 ST	2006	2012	HB179	NEW	BMW	1150	R 1150 R / ROCKSTER	2002	2005	HB150	
BMW	800	F 650 GS	2007	2011	HB180	NEW	BMW	1150	R 1150 GS / PARIS DAKAR	1998	2003	HB150	
BMW	800	F 800 GS	2008	2008	HB181		BMW	1150	R 1150 R / ROCKSTER	2002	2005	HB151	
BMW	800	F 800 GT	2013	2013	HB181		BMW	1150	R 1150 GS / PARIS DAKAR	1998	2003	HB151	
BMW	800	F 800 R	2009	2009	HB181		BMW	1150	R 1150 R / ROCKSTER	2002	2005	HB152	
BMW	800	F 800 GS	2008	2008	HB183	NEW	BMW	1150	R 1150 GS / PARIS DAKAR	1998	2003	HB152	
BMW	800	F 800 GT	2013	2013	HB183	NEW	BMW	1150	R1150 R	2000	2004	HB156	
BMW	800	F 800 R	2009	2009	HB183	NEW	BMW	1150	R1150 R	2005	2006	HB156	
BMW	850	R 850 R	1994	2002	HB150		BMW	1150	R1150R ROCKSTER	2003	2004	HB156	
BMW	850	R 850 R	1994	2002	HB150		BMW	1150	R1150R ROCKSTER	2006	2006	HB156	
BMW	850	R 850 R	1994	2002	HB150		BMW	1150	R 1150 R / ROCKSTER	2002	2005	HB162	
BMW	850	R 850 R	1994	2002	HB151		BMW	1150	R 1150 GS / PARIS DAKAR	1998	2003	HB162	
BMW	850	R 850 R	1994	2002	HB151		BMW	1150	R 1150 R / ROCKSTER	2002	2005	HB163	
BMW	850	R 850 R	1994	2002	HB151		BMW	1150	R 1150 GS / PARIS DAKAR	1998	2003	HB163	
BMW	850	R 850 R	1994	2002	HB152		BMW	1150	R 1150 R / ROCKSTER	2002	2005	HB174	
BMW	850	R 850 R	1994	2002	HB152		BMW	1150	R 1150 GS / PARIS DAKAR	1998	2003	HB174	
BMW	850	R 850 R	1994	2002	HB152		BMW	1150	R 1150 R / ROCKSTER	2002	2005	HB175	
BMW	850	R 850 R	1994	2002	HB162		BMW	1150	R 1150 GS / PARIS DAKAR	1998	2003	HB175	
BMW	850	R 850 R	1994	2002	HB162		BMW	1150	R 1150 R / ROCKSTER	2002	2005	HB179	NEW
BMW	850	R 850 R	1994	2002	HB162		BMW	1150	R 1150 GS / PARIS DAKAR	1998	2003	HB179	NEW
BMW	850	R 850 R	1994	2002	HB163		BMW	1150	R 1150 R / ROCKSTER	2002	2005	HB180	NEW
BMW	850	R 850 R	1994	2002	HB163		BMW	1150	R 1150 GS / PARIS DAKAR	1998	2003	HB180	NEW
BMW	850	R 850 R	1994	2002	HB163		BMW	1170	R 1200 R	2005	2007	HB150	
BMW	850	R 850 R	1994	2002	HB174		BMW	1170	R 1200 R	2005	2007	HB151	
BMW	850	R 850 R	1994	2002	HB174		BMW	1170	R 1200 R	2005	2007	HB152	
BMW	850	R 850 R	1994	2002	HB174		BMW	1170	R 1200 R	2005	2007	HB162	

BRAKE/CLUTCH
MASTER CYLINDERS
 ACCESSORIES
SPARE PARTS
 CNC-WORKED FLUID
RESERVOIR
 FULL CLUTCH
 HYDRAULIC-CLUTCH
TRANFORMATION KIT
 LEVER
 THROTTLE CONTROL
 BRAKE CALIPER
 RACING KIT
 BUTTON PANEL
 LEVER GUARD
 CLIP-ON
 STREET RACING
REARSET
 FUEL CAPS
 STEERING NUT
 CRASH PADS
 PADDOCK STAND
 MIRROR COVERS
 REAR-VIEW MIRRORS
 FOG LIGHTS KIT
 HANDLEBARS
ACCESSORIES
 HANDLEBARS

Marca Brand	CC	Modello Model	Dal From	Al To	Codice Code	Novità New	Marca Brand	CC	Modello Model	Dal From	Al To	Codice Code	Novità New
BMW	1170	R 1200 R	2005	2007	HB163		DUCATI	400	MONSTER 400	2000	2003	HB152	
BMW	1170	R 1200 R	2005	2007	HB175		DUCATI	400	MONTSER 400/400 I.E.	2004	2008	HB152	
BMW	1170	R 1200 R	2005	2007	HB179	NEW	DUCATI	400	MONSTER 400	2000	2003	HB162	
BMW	1170	HP 2 MEGAMOTO	2006	2012	HB181		DUCATI	400	MONTSER 400/400 I.E.	2004	2008	HB162	
BMW	1170	HP 2 ENDURO	2004	2006	HB181		DUCATI	400	MONSTER 400	2000	2003	HB163	
BMW	1170	R NINE T	2014	2014	HB181		DUCATI	400	MONTSER 400/400 I.E.	2004	2008	HB163	
BMW	1170	R 1200 R	2005	2007	HB181		DUCATI	400	MONSTER 400	2000	2003	HB167	
BMW	1170	R 1200 GS	2013	2013	HB181		DUCATI	400	MONTSER 400/400 I.E.	2004	2008	HB167	
BMW	1170	HP 2 MEGAMOTO	2006	2012	HB183	NEW	DUCATI	400	MONSTER 400	2000	2003	HB174	
BMW	1170	HP 2 ENDURO	2004	2006	HB183	NEW	DUCATI	400	MONTSER 400/400 I.E.	2004	2008	HB174	
BMW	1170	R NINE T	2014	2014	HB183	NEW	DUCATI	400	MONSTER 400	2000	2003	HB175	
BMW	1170	R 1200 R	2005	2007	HB183	NEW	DUCATI	400	MONTSER 400/400 I.E.	2004	2008	HB175	
BMW	1170	R 1200 GS	2013	2013	HB183	NEW	DUCATI	400	MONSTER 400	2000	2003	HB179	NEW
BMW	1200	R1200R	2006	2016	HB156		DUCATI	400	MONTSER 400/400 I.E.	2004	2008	HB179	NEW
BMW	1200	R 1200 GS / PARIS DAKAR	2002	2007	HB181		DUCATI	600	MONSTER 600	1999	2001	HB150	
BMW	1200	R 1200 GS / PARIS DAKAR	2002	2007	HB183	NEW	DUCATI	600	MONSTER 600	1993	1998	HB150	
BUELL	984	XB9S LIGHTNING	2004	2004	HB150		DUCATI	600	MONSTER 600	1993	1998	HB151	
BUELL	984	XB9S LIGHTNING	2004	2004	HB151		DUCATI	600	MONSTER 600	1999	2001	HB151	
BUELL	984	XB9S LIGHTNING	2004	2004	HB152		DUCATI	600	MONSTER 600	1993	1998	HB152	
BUELL	984	XB9S LIGHTNING	2004	2004	HB162		DUCATI	600	MONSTER 600	1999	2001	HB152	
BUELL	984	XB9S LIGHTNING	2004	2004	HB163		DUCATI	600	MONSTER	1993	2001	HB158	
BUELL	984	XB9S LIGHTNING	2004	2004	HB175		DUCATI	600	MONSTER 600	1993	1998	HB162	
BUELL	984	XB9S LIGHTNING	2004	2004	HB179	NEW	DUCATI	600	MONSTER 600	1999	2001	HB162	
BUELL	1200	XB12S LIGHTNING	2004	2004	HB150		DUCATI	600	MONSTER 600	1993	1998	HB163	
BUELL	1200	S1 LIGHTNING 1200	1999	2002	HB150		DUCATI	600	MONSTER 600	1999	2001	HB163	
BUELL	1200	S2 THUNDERBOLT 1200	1993	1994	HB150		DUCATI	600	MONSTER 600	1993	1998	HB167	
BUELL	1200	S1 LIGHTNING 1200	1999	2002	HB151		DUCATI	600	MONSTER 600	1999	2001	HB167	
BUELL	1200	S2 THUNDERBOLT 1200	1993	1994	HB151		DUCATI	600	MONSTER 600	1993	2001	HB169	
BUELL	1200	XB12S LIGHTNING	2004	2004	HB151		DUCATI	600	MONSTER 600	1993	1998	HB174	
BUELL	1200	S1 LIGHTNING 1200	1999	2002	HB152		DUCATI	600	MONSTER 600	1999	2001	HB174	
BUELL	1200	S2 THUNDERBOLT 1200	1993	1994	HB152		DUCATI	600	MONSTER 600	1993	1998	HB175	
BUELL	1200	XB12S LIGHTNING	2004	2004	HB152		DUCATI	600	MONSTER 600	1999	2001	HB175	
BUELL	1200	S1 LIGHTNING 1200	1999	2002	HB162		DUCATI	600	MONSTER 600	1993	1998	HB179	NEW
BUELL	1200	S2 THUNDERBOLT 1200	1993	1994	HB162		DUCATI	600	MONSTER 600	1999	2001	HB179	NEW
BUELL	1200	XB12S LIGHTNING	2004	2004	HB162		DUCATI	620	MONSTER 620 / DARK	2002	2006	HB150	
BUELL	1200	S1 LIGHTNING 1200	1999	2002	HB163		DUCATI	620	MULTISTRADA 620	2006	2006	HB150	
BUELL	1200	S2 THUNDERBOLT 1200	1993	1994	HB163		DUCATI	620	MONSTER 620 / DARK	2002	2006	HB151	
BUELL	1200	XB12S LIGHTNING	2004	2004	HB163		DUCATI	620	MULTISTRADA 620	2006	2006	HB151	
BUELL	1200	S1 LIGHTNING 1200	1999	2002	HB167		DUCATI	620	MONSTER 620 / DARK	2002	2006	HB152	
BUELL	1200	S2 THUNDERBOLT 1200	1993	1994	HB167		DUCATI	620	MULTISTRADA 620	2006	2006	HB152	
BUELL	1200	S1 LIGHTNING 1200	1999	2002	HB174		DUCATI	620	MONSTER	2002	2006	HB158	
BUELL	1200	S2 THUNDERBOLT 1200	1993	1994	HB174		DUCATI	620	MONSTER 620 / DARK	2002	2006	HB162	
BUELL	1200	S1 LIGHTNING 1200	1999	2002	HB175		DUCATI	620	MULTISTRADA 620	2006	2006	HB162	
BUELL	1200	S2 THUNDERBOLT 1200	1993	1994	HB175		DUCATI	620	MONSTER 620 / DARK	2002	2006	HB163	
BUELL	1200	XB12S LIGHTNING	2004	2004	HB175		DUCATI	620	MULTISTRADA 620	2006	2006	HB163	
BUELL	1200	S1 LIGHTNING 1200	1999	2002	HB179	NEW	DUCATI	620	MONSTER 620 / DARK	2002	2006	HB167	
BUELL	1200	S2 THUNDERBOLT 1200	1993	1994	HB179	NEW	DUCATI	620	MONSTER 620	2002	2006	HB169	
BUELL	1200	XB12S LIGHTNING	2004	2004	HB179	NEW	DUCATI	620	MONSTER 620 / DARK	2002	2006	HB174	
BUELL	1200	S1 LIGHTNING 1200	1999	2002	HB180	NEW	DUCATI	620	MONSTER 620 / DARK	2002	2006	HB175	
BUELL	1200	S2 THUNDERBOLT 1200	1993	1994	HB180	NEW	DUCATI	620	MULTISTRADA 620	2006	2006	HB175	
CAGIVA	600	CANYON 600	1995	1998	HB180	NEW	DUCATI	620	MONSTER 620 / DARK	2002	2006	HB179	NEW
CAGIVA	900	GRAN CANYON 900 I.E.	1998	2000	HB180	NEW	DUCATI	620	MULTISTRADA 620	2006	2006	HB179	NEW
DUCATI	400	MONTSER 400/400 I.E.	2004	2008	HB150		DUCATI	620	MULTISTRADA 620	2006	2006	HB180	NEW
DUCATI	400	MONSTER 400	2000	2003	HB150		DUCATI	695	MONSTER 695	2007	2008	HB150	
DUCATI	400	MONSTER 400	2000	2003	HB151		DUCATI	695	MONSTER 695	2007	2008	HB151	
DUCATI	400	MONTSER 400/400 I.E.	2004	2008	HB151		DUCATI	695	MONSTER 695	2007	2008	HB152	

- BRAKE/CLUTCH MASTER CYLINDERS
- ACCESSORIES SPARE PARTS
- CNC-WORKED FLUID RESERVOIR
- FULL CLUTCH
- HYDRAULIC-CLUTCH TRANFORMATION KIT
- LEVER
- THROTTLE CONTROL
- BRAKE CALIPER
- RACING KIT
- BUTTON PANEL
- LEVER GUARD
- CLIP-ON
- STREET RACING REARSET
- FUEL CAPS
- STEERING NUT
- CRASH PADS
- PADDOCK STAND
- MIRROR COVERS
- REAR-VIEW MIRRORS
- FOG LIGHTS KIT
- HANDLEBARS ACCESSORIES
- HANDLEBARS

Marca Brand	CC	Modello Model	Dal From	Al To	Codice Code	Novità New	Marca Brand	CC	Modello Model	Dal From	Al To	Codice Code	Novità New
DUCATI	695	MONSTER 695	2007	2008	HB162		DUCATI	900	MONSTER 900	2002	2002	HB151	
DUCATI	695	MONSTER 695	2007	2008	HB163		DUCATI	900	MONSTER 900 / S2R 1000	2006	2008	HB151	
DUCATI	695	MONSTER 695	2007	2008	HB167		DUCATI	900	MONSTER 900	1993	1999	HB152	
DUCATI	695	MONSTER 695	2007	2008	HB174		DUCATI	900	MONSTER 900	2000	2002	HB152	
DUCATI	695	MONSTER 695	2007	2008	HB175		DUCATI	900	MONSTER 900	2002	2002	HB152	
DUCATI	695	MONSTER 695	2007	2008	HB179	NEW	DUCATI	900	MONSTER 900 / S2R 1000	2006	2008	HB152	
DUCATI	750	MONSTER 750	1999	2002	HB150		DUCATI	900	MONSTER 900	1993	1999	HB162	
DUCATI	750	MONSTER 750	2002	2002	HB150		DUCATI	900	MONSTER 900	2000	2002	HB162	
DUCATI	750	MONSTER 750	1996	2001	HB150		DUCATI	900	MONSTER 900	2002	2002	HB162	
DUCATI	750	MONSTER 750	1999	2002	HB151		DUCATI	900	MONSTER 900 / S2R 1000	2006	2008	HB162	
DUCATI	750	MONSTER 750	1996	2001	HB151		DUCATI	900	MONSTER 900	1993	1999	HB163	
DUCATI	750	MONSTER 750	2002	2002	HB151		DUCATI	900	MONSTER 900	2000	2002	HB163	
DUCATI	750	MONSTER 750	1999	2002	HB152		DUCATI	900	MONSTER 900	2002	2002	HB163	
DUCATI	750	MONSTER 750	1996	2001	HB152		DUCATI	900	MONSTER 900 / S2R 1000	2006	2008	HB163	
DUCATI	750	MONSTER 750	2002	2002	HB152		DUCATI	900	MONSTER 900	1993	1999	HB167	
DUCATI	750	MONSTER 750	1999	2002	HB162		DUCATI	900	MONSTER 900	2000	2002	HB167	
DUCATI	750	MONSTER 750	1996	2001	HB162		DUCATI	900	MONSTER 900	2002	2002	HB167	
DUCATI	750	MONSTER 750	2002	2002	HB162		DUCATI	900	MONSTER 900 / S2R 1000	2006	2008	HB167	
DUCATI	750	MONSTER 750	1999	2002	HB163		DUCATI	900	MONSTER 900	1993	2002	HB170	
DUCATI	750	MONSTER 750	1996	2001	HB163		DUCATI	900	MONSTER 900	1993	1999	HB174	
DUCATI	750	MONSTER 750	2002	2002	HB163		DUCATI	900	MONSTER 900	2000	2002	HB174	
DUCATI	750	MONSTER 750	1999	2002	HB167		DUCATI	900	MONSTER 900	2002	2002	HB174	
DUCATI	750	MONSTER 750	1996	2001	HB167		DUCATI	900	MONSTER 900	1993	1999	HB175	
DUCATI	750	MONSTER 750	2002	2002	HB167		DUCATI	900	MONSTER 900	2000	2002	HB175	
DUCATI	750	MONSTER 750	1996	2002	HB169		DUCATI	900	MONSTER 900	2002	2002	HB175	
DUCATI	750	MONSTER 750	1999	2002	HB174		DUCATI	900	MONSTER 900 / S2R 1000	2006	2008	HB175	NEW
DUCATI	750	MONSTER 750	1996	2001	HB174		DUCATI	900	MONSTER 900	1993	1999	HB179	NEW
DUCATI	750	MONSTER 750	2002	2002	HB174		DUCATI	900	MONSTER 900	2000	2002	HB179	NEW
DUCATI	750	MONSTER 750	1999	2002	HB175		DUCATI	900	MONSTER 900	2002	2002	HB179	NEW
DUCATI	750	MONSTER 750	1996	2001	HB175		DUCATI	900	MONSTER 900 / S2R 1000	2006	2008	HB179	NEW
DUCATI	750	MONSTER 750	2002	2002	HB175		DUCATI	996	MONSTER S4-R / S4RS	2003	2006	HB181	
DUCATI	750	MONSTER 750	1999	2002	HB179	NEW	DUCATI	996	MONSTER S4-R / S4RS	2003	2006	HB183	NEW
DUCATI	750	MONSTER 750	1996	2001	HB179	NEW	DUCATI	1000	GT 1000 / TOURING	2007	2010	HB150	
DUCATI	750	MONSTER 750	2002	2002	HB179	NEW	DUCATI	1000	MONSTER 900 / S2R 1000	2006	2008	HB150	
DUCATI	800	MONSTER 800 / S2R	2003	2007	HB150		DUCATI	1000	MULTISTRADA 1000 DS	2003	2006	HB150	
DUCATI	800	MONSTER 800 / S2R	2003	2007	HB151		DUCATI	1000	MONSTER 1000	2003	2005	HB150	
DUCATI	800	MONSTER 800 / S2R	2003	2007	HB152		DUCATI	1000	MONSTER 900 / S2R 1000	2006	2008	HB151	
DUCATI	800	MONSTER 800 / S2R	2003	2007	HB162		DUCATI	1000	GT 1000 / TOURING	2007	2010	HB151	
DUCATI	800	MONSTER 800 / S2R	2003	2007	HB163		DUCATI	1000	MONSTER 1000	2003	2005	HB151	
DUCATI	800	MONSTER 800 / S2R	2003	2007	HB167		DUCATI	1000	MULTISTRADA 1000 DS	2003	2006	HB151	
DUCATI	800	MONSTER 800	2003	2004	HB170		DUCATI	1000	MONSTER 900 / S2R 1000	2006	2008	HB152	
DUCATI	800	MONSTER 800 / S2R	2003	2007	HB174		DUCATI	1000	GT 1000 / TOURING	2007	2010	HB152	
DUCATI	800	MONSTER 800 / S2R	2003	2007	HB175		DUCATI	1000	MONSTER 1000	2003	2005	HB152	
DUCATI	800	MONSTER 800 / S2R	2003	2007	HB179	NEW	DUCATI	1000	MULTISTRADA 1000 DS	2003	2006	HB152	
DUCATI	800	MONSTER 796	2011	2012	HB181		DUCATI	1000	MONSTER 900 / S2R 1000	2006	2008	HB162	
DUCATI	800	MONSTER 796	2011	2012	HB183	NEW	DUCATI	1000	GT 1000 / TOURING	2007	2010	HB162	
DUCATI	821	HYPERSTRADA	2013	2013	HB181		DUCATI	1000	MONSTER 1000	2003	2005	HB162	
DUCATI	821	HYPERMOTARD	2013	2013	HB181		DUCATI	1000	MULTISTRADA 1000 DS	2003	2006	HB162	
DUCATI	821	HYPERSTRADA	2013	2013	HB183	NEW	DUCATI	1000	MONSTER 900 / S2R 1000	2006	2008	HB163	
DUCATI	821	HYPERMOTARD	2013	2013	HB183	NEW	DUCATI	1000	GT 1000 / TOURING	2007	2010	HB163	
DUCATI	900	MONSTER 900	2002	2002	HB150		DUCATI	1000	MONSTER 1000	2003	2005	HB163	
DUCATI	900	MONSTER 900 / S2R 1000	2006	2008	HB150		DUCATI	1000	MULTISTRADA 1000 DS	2003	2006	HB163	
DUCATI	900	MONSTER 900	2000	2002	HB150		DUCATI	1000	MONSTER 900 / S2R 1000	2006	2008	HB167	
DUCATI	900	MONSTER 900	1993	1999	HB150		DUCATI	1000	GT 1000 / TOURING	2007	2010	HB167	
DUCATI	900	MONSTER 900	1993	1999	HB151		DUCATI	1000	MONSTER 1000	2003	2005	HB174	
DUCATI	900	MONSTER 900	2000	2002	HB151		DUCATI	1000	MULTISTRADA 1000 DS	2003	2006	HB174	

BRAKE/CLUTCH
MASTER CYLINDERS
 ACCESSORIES
SPARE PARTS
 CNC-WORKED FLUID
RESERVOIR
 FULL CLUTCH
 HYDRAULIC-CLUTCH
TRANFORMATION KIT
 LEVER
 THROTTLE CONTROL
 BRAKE CALIPER
 RACING KIT
 BUTTON PANEL
 LEVER GUARD
 CLIP-ON
 STREET RACING
REARSET
 FUEL CAPS
 STEERING NUT
 CRASH PADS
 PADDOCK STAND
 MIRROR COVERS
 REAR-VIEW MIRRORS
 FOG LIGHTS KIT
 HANDLEBARS
ACCESSORIES
 HANDLEBARS

Marca Brand	CC	Modello Model	Dal From	Al To	Codice Code	Novità New	Marca Brand	CC	Modello Model	Dal From	Al To	Codice Code	Novità New
DUCATI	1000	MONSTER 900 / S2R 1000	2006	2008	HB175		HONDA	500	CB 500	1994	1994	HB150	
DUCATI	1000	GT 1000 / TOURING	2007	2010	HB175		HONDA	500	CB 500	1994	1994	HB150	
DUCATI	1000	MONSTER 1000	2003	2005	HB175		HONDA	500	CB 500	1994	1994	HB151	
DUCATI	1000	MULTISTRADA 1000 DS	2003	2006	HB175		HONDA	500	CB 500 F	2013	2013	HB151	
DUCATI	1000	MONSTER 900 / S2R 1000	2006	2008	HB179	NEW	HONDA	500	CB 500	1994	1994	HB151	
DUCATI	1000	GT 1000 / TOURING	2007	2010	HB179	NEW	HONDA	500	CBF 500 / A	2004	2007	HB151	
DUCATI	1000	MONSTER 1000	2003	2005	HB179	NEW	HONDA	500	CB 500 X	2013	2016	HB151	
DUCATI	1000	MULTISTRADA 1000 DS	2003	2006	HB179	NEW	HONDA	500	CB 500	1994	1994	HB152	
DUCATI	1000	MONSTER 1000	2003	2005	HB180	NEW	HONDA	500	CB 500 F	2013	2013	HB152	
DUCATI	1000	MULTISTRADA 1000 DS	2003	2006	HB180	NEW	HONDA	500	CB 500	1994	1994	HB152	
DUCATI	1098	STREETFIGHTER / S	2009	2014	HB181		HONDA	500	CBF 500 / A	2004	2007	HB152	
DUCATI	1098	STREETFIGHTER / S	2009	2014	HB183	NEW	HONDA	500	CB 500 X	2013	2016	HB152	
DUCATI	1100	HYPERMOTARD 1100 EVO SP	2010	2012	HB181		HONDA	500	CB 500	1994	1994	HB162	
DUCATI	1100	MONSTER 1100 / S	2009	2010	HB181		HONDA	500	CB 500 F	2013	2013	HB162	
DUCATI	1100	MULTISTRADA 1100	2007	2009	HB181		HONDA	500	CB 500	1994	1994	HB162	
DUCATI	1100	HYPERMOTARD 1100 / S	2008	2009	HB181		HONDA	500	CBF 500 / A	2004	2007	HB162	
DUCATI	1100	HYPERMOTARD 1100 EVO SP	2010	2012	HB183	NEW	HONDA	500	CB 500 X	2013	2016	HB162	
DUCATI	1100	MONSTER 1100 / S	2009	2010	HB183	NEW	HONDA	500	CB 500	1994	1994	HB163	
DUCATI	1100	MULTISTRADA 1100	2007	2009	HB183	NEW	HONDA	500	CB 500 F	2013	2013	HB163	
DUCATI	1100	HYPERMOTARD 1100 / S	2008	2009	HB183	NEW	HONDA	500	CB 500	1994	1994	HB163	
DUCATI	1200	MONSTER 1200 / S	2010	2016	HB181		HONDA	500	CBF 500 / A	2004	2007	HB163	
DUCATI	1200	MULTISTRADA 1200	2010	2012	HB181		HONDA	500	CB 500 X	2013	2016	HB163	
DUCATI	1200	DIAVEL	2011	2012	HB181		HONDA	500	CB 500	1994	1994	HB167	
DUCATI	1200	MONSTER 1200 / S	2010	2016	HB183	NEW	HONDA	500	CB 500 F	2013	2013	HB167	
DUCATI	1200	MULTISTRADA 1200	2010	2012	HB183	NEW	HONDA	500	CB 500	1994	1994	HB167	
DUCATI	1200	DIAVEL	2011	2012	HB183	NEW	HONDA	500	CBF 500 / A	2004	2007	HB167	
HONDA	125	VARADERO 125	2001	2011	HB150		HONDA	500	CB 500 X	2013	2016	HB167	
HONDA	125	VARADERO 125	2001	2011	HB151		HONDA	500	CB 500	1994	1994	HB174	
HONDA	125	VARADERO 125	2001	2011	HB152		HONDA	500	CB 500 F	2013	2013	HB174	
HONDA	125	VARADERO 125	2001	2011	HB162		HONDA	500	CB 500	1994	1994	HB174	
HONDA	125	VARADERO 125	2001	2011	HB163		HONDA	500	CBF 500 / A	2004	2007	HB174	
HONDA	125	VARADERO 125	2001	2011	HB175		HONDA	500	CB 500 X	2013	2016	HB174	
HONDA	125	VARADERO 125	2001	2011	HB180	NEW	HONDA	500	CB 500	1994	1994	HB175	
HONDA	250	CB 250 TWO FIFTY	1999	2001	HB150		HONDA	500	CB 500 F	2013	2013	HB175	
HONDA	250	CB 250 TWO FIFTY	1999	2001	HB151		HONDA	500	CB 500	1994	1994	HB175	
HONDA	250	CB 250 TWO FIFTY	1999	2001	HB152		HONDA	500	CBF 500 / A	2004	2007	HB175	
HONDA	250	CB 250 TWO FIFTY	1999	2001	HB162		HONDA	500	CB 500 X	2013	2016	HB175	
HONDA	250	CB 250 TWO FIFTY	1999	2001	HB163		HONDA	500	CB 500	1994	1994	HB179	NEW
HONDA	250	CB 250 TWO FIFTY	1999	2001	HB167		HONDA	500	CB 500 F	2013	2013	HB179	NEW
HONDA	250	CB 250 TWO FIFTY	1999	2001	HB174		HONDA	500	CB 500	1994	1994	HB179	NEW
HONDA	250	CB 250 TWO FIFTY	1999	2001	HB175		HONDA	500	CBF 500 / A	2004	2007	HB179	NEW
HONDA	250	CB 250 TWO FIFTY	1999	2001	HB179	NEW	HONDA	500	CB 500 X	2013	2016	HB179	NEW
HONDA	250	CB 250 TWO FIFTY	1999	2001	HB180	NEW	HONDA	500	CB 500	1994	1994	HB180	NEW
HONDA	400	CB 400 N	1979	1983	HB150		HONDA	500	CB 500 F	2013	2013	HB180	NEW
HONDA	400	CB 400 N	1979	1983	HB151		HONDA	500	CB 500	1994	1994	HB180	NEW
HONDA	400	CB 400 N	1979	1983	HB152		HONDA	500	CBF 500 / A	2004	2007	HB180	NEW
HONDA	400	CB 400 N	1979	1983	HB162		HONDA	500	CB 500 X	2013	2016	HB180	NEW
HONDA	400	CB 400 N	1979	1983	HB163		HONDA	600	CBF 600/S	2008	2013	HB150	
HONDA	400	CB 400 N	1979	1983	HB167		HONDA	600	CBF 600/S	2004	2007	HB150	
HONDA	400	CB 400 N	1979	1983	HB174		HONDA	600	CB 600 F HORNET	2002	2006	HB150	
HONDA	400	CB 400 N	1979	1983	HB175		HONDA	600	HORNET 600	2007	2006	HB150	
HONDA	400	CB 400 N	1979	1983	HB179	NEW	HONDA	600	CB 600 F HORNET	1998	2003	HB150	
HONDA	400	CB 400 N	1979	1983	HB180	NEW	HONDA	600	CB 600 F HORNET	2000	2001	HB150	
HONDA	500	CB 500 F	2013	2013	HB150		HONDA	600	CB 600 F HORNET	1998	2003	HB151	
HONDA	500	CB 500 X	2013	2016	HB150		HONDA	600	CB 600 F HORNET	2000	2001	HB151	
HONDA	500	CBF 500 / A	2004	2007	HB150		HONDA	600	CB 600 F HORNET	2002	2006	HB151	

- BRAKE/CLUTCH MASTER CYLINDERS
- ACCESSORIES SPARE PARTS
- CNC-WORKED FLUID RESERVOIR
- FULL CLUTCH
- HYDRAULIC-CLUTCH TRANFORMATION KIT
- LEVER
- THROTTLE CONTROL
- BRAKE CALIPER
- RACING KIT
- BUTTON PANEL
- LEVER GUARD
- CLIP-ON
- STREET RACING REARSET
- FUEL CAPS
- STEERING NUT
- CRASH PADS
- PADOCK STAND
- MIRROR COVERS
- REAR-VIEW MIRRORS
- FOG LIGHTS KIT
- HANDLEBARS ACCESSORIES
- HANDLEBARS

Marca Brand	CC	Modello Model	Dal From	Al To	Codice Code	Novità New	Marca Brand	CC	Modello Model	Dal From	Al To	Codice Code	Novità New
HONDA	600	HORNET 600	2007	2006	HB151		HONDA	650	XL 650 V TRANSALP	2000	2003	HB150	
HONDA	600	CBF 600/S	2004	2007	HB151		HONDA	650	FX 650 VIGOR	1999	2002	HB150	
HONDA	600	CBF 600/S	2008	2013	HB151		HONDA	650	NTV 650 REVERE	1988	2001	HB150	
HONDA	600	CB 600 F HORNET	1998	2003	HB152		HONDA	650	NT 650 V DEAUVILLE	1998	2001	HB150	
HONDA	600	CB 600 F HORNET	2000	2001	HB152		HONDA	650	NT 650 V DEAUVILLE	1998	2001	HB150	
HONDA	600	CB 600 F HORNET	2002	2006	HB152		HONDA	650	SLR 650	1999	1999	HB150	
HONDA	600	HORNET 600	2007	2006	HB152		HONDA	650	XRV 650 AFRICA TWIN	1988	1990	HB150	
HONDA	600	CBF 600/S	2004	2007	HB152		HONDA	650	NX 650 DOMINATOR	1988	1989	HB150	
HONDA	600	CBF 600/S	2008	2013	HB152		HONDA	650	FX 650 VIGOR	1999	2002	HB151	
HONDA	600	HORNET 600	1998	2013	HB159		HONDA	650	NTV 650 REVERE	1988	2001	HB151	
HONDA	600	HORNET 600	2007	2013	HB160		HONDA	650	NX 650 DOMINATOR	1988	1989	HB151	
HONDA	600	HORNET 600	2007	2013	HB161		HONDA	650	NT 650 V DEAUVILLE	1998	2001	HB151	
HONDA	600	CB 600 F HORNET	1998	2003	HB162		HONDA	650	NT 650 V DEAUVILLE	1998	2001	HB151	
HONDA	600	CB 600 F HORNET	2000	2001	HB162		HONDA	650	SLR 650	1999	1999	HB151	
HONDA	600	CB 600 F HORNET	2002	2006	HB162		HONDA	650	XL 650 V TRANSALP	2001	2003	HB151	
HONDA	600	HORNET 600	2007	2006	HB162		HONDA	650	XL 650 V TRANSALP	2000	2003	HB151	
HONDA	600	CBF 600/S	2004	2007	HB162		HONDA	650	XRV 650 AFRICA TWIN	1988	1990	HB151	
HONDA	600	CBF 600/S	2008	2013	HB162		HONDA	650	FX 650 VIGOR	1999	2002	HB152	
HONDA	600	CB 600 F HORNET	1998	2003	HB163		HONDA	650	NTV 650 REVERE	1988	2001	HB152	
HONDA	600	CB 600 F HORNET	2000	2001	HB163		HONDA	650	NX 650 DOMINATOR	1988	1989	HB152	
HONDA	600	CB 600 F HORNET	2002	2006	HB163		HONDA	650	NT 650 V DEAUVILLE	1998	2001	HB152	
HONDA	600	HORNET 600	2007	2006	HB163		HONDA	650	NT 650 V DEAUVILLE	1998	2001	HB152	
HONDA	600	CBF 600/S	2004	2007	HB163		HONDA	650	SLR 650	1999	1999	HB152	
HONDA	600	CBF 600/S	2008	2013	HB163		HONDA	650	XL 650 V TRANSALP	2001	2003	HB152	
HONDA	600	CB 600 F HORNET	1998	2003	HB167		HONDA	650	XL 650 V TRANSALP	2000	2003	HB152	
HONDA	600	CB 600 F HORNET	2000	2001	HB167		HONDA	650	XRV 650 AFRICA TWIN	1988	1990	HB152	
HONDA	600	CB 600 F HORNET	2002	2006	HB167		HONDA	650	FX 650 VIGOR	1999	2002	HB162	
HONDA	600	HORNET 600	2007	2006	HB167		HONDA	650	NTV 650 REVERE	1988	2001	HB162	
HONDA	600	CBF 600/S	2004	2007	HB167		HONDA	650	NX 650 DOMINATOR	1988	1989	HB162	
HONDA	600	CBF 600/S	2008	2013	HB167		HONDA	650	NT 650 V DEAUVILLE	1998	2001	HB162	
HONDA	600	HORNET 600	1998	2011	HB171		HONDA	650	NT 650 V DEAUVILLE	1998	2001	HB162	
HONDA	600	CB 600 F HORNET	1998	2003	HB174		HONDA	650	SLR 650	1999	1999	HB162	
HONDA	600	CB 600 F HORNET	2000	2001	HB174		HONDA	650	XL 650 V TRANSALP	2001	2003	HB162	
HONDA	600	CB 600 F HORNET	2002	2006	HB174		HONDA	650	XL 650 V TRANSALP	2000	2003	HB162	
HONDA	600	HORNET 600	2007	2006	HB174		HONDA	650	XRV 650 AFRICA TWIN	1988	1990	HB162	
HONDA	600	CBF 600/S	2004	2007	HB174		HONDA	650	FX 650 VIGOR	1999	2002	HB163	
HONDA	600	CBF 600/S	2008	2013	HB174		HONDA	650	NTV 650 REVERE	1988	2001	HB163	
HONDA	600	CB 600 F HORNET	1998	2003	HB175		HONDA	650	NX 650 DOMINATOR	1988	1989	HB163	
HONDA	600	CB 600 F HORNET	2000	2001	HB175		HONDA	650	NT 650 V DEAUVILLE	1998	2001	HB163	
HONDA	600	CB 600 F HORNET	2002	2006	HB175		HONDA	650	NT 650 V DEAUVILLE	1998	2001	HB163	
HONDA	600	HORNET 600	2007	2006	HB175		HONDA	650	SLR 650	1999	1999	HB163	
HONDA	600	CBF 600/S	2004	2007	HB175		HONDA	650	XL 650 V TRANSALP	2001	2003	HB163	
HONDA	600	CBF 600/S	2008	2013	HB175		HONDA	650	XL 650 V TRANSALP	2000	2003	HB163	
HONDA	600	CB 600 F HORNET	1998	2003	HB179	NEW	HONDA	650	XRV 650 AFRICA TWIN	1988	1990	HB163	
HONDA	600	CB 600 F HORNET	2000	2001	HB179	NEW	HONDA	650	NTV 650 REVERE	1988	2001	HB167	
HONDA	600	CB 600 F HORNET	2002	2006	HB179	NEW	HONDA	650	SLR 650	1999	1999	HB167	
HONDA	600	HORNET 600	2007	2006	HB179	NEW	HONDA	650	NTV 650 REVERE	1988	2001	HB174	
HONDA	600	CBF 600/S	2004	2007	HB179	NEW	HONDA	650	SLR 650	1999	1999	HB174	
HONDA	600	CBF 600/S	2008	2013	HB179	NEW	HONDA	650	FX 650 VIGOR	1999	2002	HB175	
HONDA	600	CB 600 F HORNET	1998	2003	HB180	NEW	HONDA	650	NTV 650 REVERE	1988	2001	HB175	
HONDA	600	CB 600 F HORNET	2000	2001	HB180	NEW	HONDA	650	NX 650 DOMINATOR	1988	1989	HB175	
HONDA	600	CB 600 F HORNET	2002	2006	HB180	NEW	HONDA	650	NT 650 V DEAUVILLE	1998	2001	HB175	
HONDA	600	HORNET 600	2007	2006	HB180	NEW	HONDA	650	NT 650 V DEAUVILLE	1998	2001	HB175	
HONDA	600	CBF 600/S	2004	2007	HB180	NEW	HONDA	650	SLR 650	1999	1999	HB175	
HONDA	600	CBF 600/S	2008	2013	HB180	NEW	HONDA	650	XL 650 V TRANSALP	2001	2003	HB175	
HONDA	650	XL 650 V TRANSALP	2001	2003	HB150		HONDA	650	XL 650 V TRANSALP	2000	2003	HB175	

- BRAKE/CLUTCH MASTER CYLINDERS
- ACCESSORIES SPARE PARTS
- CNC-WORKED FLUID RESERVOIR
- FULL CLUTCH
- HYDRAULIC-CLUTCH TRANFORMATION KIT
- LEVER
- THROTTLE CONTROL
- BRAKE CALIPER
- RACING KIT
- BUTTON PANEL
- LEVER GUARD
- CLIP-ON
- STREET RACING REARSET
- FUEL CAPS
- STEERING NUT
- CRASH PADS
- PADDOCK STAND
- MIRROR COVERS
- REAR-VIEW MIRRORS
- FOG LIGHTS KIT
- HANDLEBARS ACCESSORIES
- HANDLEBARS

Marca Brand	CC	Modello Model	Dal From	Al To	Codice Code	Novità New	Marca Brand	CC	Modello Model	Dal From	Al To	Codice Code	Novità New
HONDA	650	XRV 650 AFRICA TWIN	1988	1990	HB175		HONDA	750	NC 750 S / X	2014	2016	HB175	
HONDA	650	FX 650 VIGOR	1999	2002	HB179	NEW	HONDA	750	CB 750 SEVEN FIFTY	2001	2001	HB175	
HONDA	650	NTV 650 REVERE	1988	2001	HB179	NEW	HONDA	750	XRV 750 AFRICA TWIN	1990	1992	HB175	
HONDA	650	NX 650 DOMINATOR	1988	1989	HB179	NEW	HONDA	750	XRV 750 AFRICA TWIN	1993	2003	HB175	
HONDA	650	XRV 650 AFRICA TWIN	1988	1990	HB179	NEW	HONDA	750	NC 750 S / X	2014	2016	HB179	NEW
HONDA	650	FX 650 VIGOR	1999	2002	HB180	NEW	HONDA	750	CB 750 SEVEN FIFTY	2001	2001	HB179	NEW
HONDA	650	NTV 650 REVERE	1988	2001	HB180	NEW	HONDA	750	XRV 750 AFRICA TWIN	1990	1992	HB179	NEW
HONDA	650	NX 650 DOMINATOR	1988	1989	HB180	NEW	HONDA	750	XRV 750 AFRICA TWIN	1993	2003	HB179	NEW
HONDA	650	NT 650 V DEAUVILLE	1998	2001	HB180	NEW	HONDA	750	NC 750 S / X	2014	2016	HB180	NEW
HONDA	650	NT 650 V DEAUVILLE	1998	2001	HB180	NEW	HONDA	750	CB 750 SEVEN FIFTY	2001	2001	HB180	NEW
HONDA	650	SLR 650	1999	1999	HB180	NEW	HONDA	750	XRV 750 AFRICA TWIN	1990	1992	HB180	NEW
HONDA	650	XL 650 V TRANSALP	2001	2003	HB180	NEW	HONDA	750	XRV 750 AFRICA TWIN	1993	2003	HB180	NEW
HONDA	650	XL 650 V TRANSALP	2000	2003	HB180	NEW	HONDA	780	CROSSRUNNER	2011	2014	HB150	
HONDA	650	XRV 650 AFRICA TWIN	1988	1990	HB180	NEW	HONDA	780	CROSSRUNNER	2011	2014	HB151	
HONDA	700	NC 700 S / X	2012	2012	HB150		HONDA	780	CROSSRUNNER	2011	2014	HB152	
HONDA	700	XL 700 V TRANSALP	2008	2008	HB150		HONDA	780	CROSSRUNNER	2011	2014	HB162	
HONDA	700	NC 700 S / X	2012	2012	HB151		HONDA	780	CROSSRUNNER	2011	2014	HB163	
HONDA	700	XL 700 V TRANSALP	2008	2008	HB151		HONDA	780	CROSSRUNNER	2011	2014	HB167	
HONDA	700	NC 700 S / X	2012	2012	HB152		HONDA	780	CROSSRUNNER	2011	2014	HB174	
HONDA	700	XL 700 V TRANSALP	2008	2008	HB152		HONDA	780	CROSSRUNNER	2011	2014	HB175	
HONDA	700	NC 700 S / X	2012	2012	HB162		HONDA	780	CROSSRUNNER	2011	2014	HB179	NEW
HONDA	700	XL 700 V TRANSALP	2008	2008	HB162		HONDA	780	CROSSRUNNER	2011	2014	HB180	NEW
HONDA	700	NC 700 S / X	2012	2012	HB163		HONDA	900	CB 900 F HORNET	2002	2005	HB150	
HONDA	700	XL 700 V TRANSALP	2008	2008	HB163		HONDA	900	CB 900 F HORNET	2002	2005	HB151	
HONDA	700	NC 700 S / X	2012	2012	HB167		HONDA	900	CB 900 F HORNET	2002	2005	HB152	
HONDA	700	NC 700 S / X	2012	2012	HB174		HONDA	900	CB 900 F HORNET	2002	2005	HB162	
HONDA	700	NC 700 S / X	2012	2012	HB175		HONDA	900	CB 900 F HORNET	2002	2005	HB163	
HONDA	700	XL 700 V TRANSALP	2008	2008	HB175		HONDA	900	CB 900 F HORNET	2002	2005	HB167	
HONDA	700	NC 700 S / X	2012	2012	HB179	NEW	HONDA	900	CB 900 F HORNET	2002	2005	HB174	
HONDA	700	XL 700 V TRANSALP	2008	2008	HB179	NEW	HONDA	900	CB 900 F HORNET	2002	2005	HB175	
HONDA	700	NC 700 S / X	2012	2012	HB180	NEW	HONDA	900	CB 900 F HORNET	2002	2005	HB179	NEW
HONDA	700	XL 700 V TRANSALP	2008	2008	HB180	NEW	HONDA	900	CB 900 F HORNET	2002	2005	HB180	NEW
HONDA	750	NC 750 S / X	2014	2016	HB150		HONDA	1000	CBF 1000/F	2006	2006	HB150	
HONDA	750	XRV 750 AFRICA TWIN	1993	2003	HB150		HONDA	1000	CB 1000 R	2008	2014	HB150	
HONDA	750	CB 750 SEVEN FIFTY	2001	2001	HB150		HONDA	1000	XL 1000 V VARADERO	2003	2010	HB150	
HONDA	750	XRV 750 AFRICA TWIN	1990	1992	HB150		HONDA	1000	XL 1000 V VARADERO	1999	2002	HB150	
HONDA	750	NC 750 S / X	2014	2016	HB151		HONDA	1000	CB 1000 R	2008	2014	HB151	
HONDA	750	CB 750 SEVEN FIFTY	2001	2001	HB151		HONDA	1000	CBF 1000/F	2006	2006	HB151	
HONDA	750	XRV 750 AFRICA TWIN	1990	1992	HB151		HONDA	1000	XL 1000 V VARADERO	1999	2002	HB151	
HONDA	750	XRV 750 AFRICA TWIN	1993	2003	HB151		HONDA	1000	XL 1000 V VARADERO	2003	2010	HB151	
HONDA	750	NC 750 S / X	2014	2016	HB152		HONDA	1000	CB 1000 R	2008	2014	HB152	
HONDA	750	CB 750 SEVEN FIFTY	2001	2001	HB152		HONDA	1000	CBF 1000/F	2006	2006	HB152	
HONDA	750	XRV 750 AFRICA TWIN	1990	1992	HB152		HONDA	1000	XL 1000 V VARADERO	1999	2002	HB152	
HONDA	750	XRV 750 AFRICA TWIN	1993	2003	HB152		HONDA	1000	XL 1000 V VARADERO	2003	2010	HB152	
HONDA	750	NC 750 S / X	2014	2016	HB162		HONDA	1000	CB 1000 R	2008	2014	HB162	
HONDA	750	CB 750 SEVEN FIFTY	2001	2001	HB162		HONDA	1000	CBF 1000/F	2006	2006	HB162	
HONDA	750	XRV 750 AFRICA TWIN	1990	1992	HB162		HONDA	1000	XL 1000 V VARADERO	1999	2002	HB162	
HONDA	750	XRV 750 AFRICA TWIN	1993	2003	HB162		HONDA	1000	XL 1000 V VARADERO	2003	2010	HB162	
HONDA	750	NC 750 S / X	2014	2016	HB163		HONDA	1000	CB 1000 R	2008	2014	HB163	
HONDA	750	CB 750 SEVEN FIFTY	2001	2001	HB163		HONDA	1000	CBF 1000/F	2006	2006	HB163	
HONDA	750	XRV 750 AFRICA TWIN	1990	1992	HB163		HONDA	1000	XL 1000 V VARADERO	1999	2002	HB163	
HONDA	750	XRV 750 AFRICA TWIN	1993	2003	HB163		HONDA	1000	XL 1000 V VARADERO	2003	2010	HB163	
HONDA	750	NC 750 S / X	2014	2016	HB167		HONDA	1000	CB 1000 R	2008	2014	HB167	
HONDA	750	CB 750 SEVEN FIFTY	2001	2001	HB167		HONDA	1000	CB 1000 R	2008	2014	HB175	
HONDA	750	NC 750 S / X	2014	2016	HB174		HONDA	1000	CBF 1000/F	2006	2006	HB175	
HONDA	750	CB 750 SEVEN FIFTY	2001	2001	HB174		HONDA	1000	XL 1000 V VARADERO	1999	2002	HB175	

- BRAKE/CLUTCH MASTER CYLINDERS
- ACCESSORIES SPARE PARTS
- CNC-WORKED FLUID RESERVOIR
- FULL CLUTCH
- HYDRAULIC-CLUTCH TRANFORMATION KIT
- LEVER
- THROTTLE CONTROL
- BRAKE CALIPER
- RACING KIT
- BUTTON PANEL
- LEVER GUARD
- CLIP-ON
- STREET RACING REARSET
- FUEL CAPS
- STEERING NUT
- CRASH PADS
- PADDOCK STAND
- MIRROR COVERS
- REAR-VIEW MIRRORS
- FOG LIGHTS KIT
- HANDLEBARS ACCESSORIES
- HANDLEBARS

Marca Brand	CC	Modello Model	Dal From	Al To	Codice Code	Novità New	Marca Brand	CC	Modello Model	Dal From	Al To	Codice Code	Novità New
HONDA	1000	XL 1000 V VARADERO	2003	2010	HB175		KAWASAKI	500	ER-5	1997	2005	HB162	
HONDA	1000	CB 1000 R	2008	2014	HB179	NEW	KAWASAKI	500	ER-5	1997	2005	HB163	
HONDA	1000	CBF 1000/F	2006	2006	HB179	NEW	KAWASAKI	500	ER-5	1997	2005	HB163	
HONDA	1000	CBF 1000/F	2006	2006	HB180	NEW	KAWASAKI	500	ER-5	1997	2005	HB167	
HONDA	1000	XL 1000 V VARADERO	1999	2002	HB180	NEW	KAWASAKI	500	ER-5	1997	2005	HB167	
HONDA	1000	XL 1000 V VARADERO	2003	2010	HB180	NEW	KAWASAKI	500	ER-5	1997	2005	HB174	
HONDA	1100	X-ELEVEN	1999	2001	HB150		KAWASAKI	500	ER-5	1997	2005	HB174	
HONDA	1100	X-ELEVEN	1999	2001	HB151		KAWASAKI	500	ER-5	1997	2005	HB175	
HONDA	1100	X-ELEVEN	1999	2001	HB152		KAWASAKI	500	ER-5	1997	2005	HB175	
HONDA	1100	X-ELEVEN	1999	2001	HB162		KAWASAKI	500	ER-5	1997	2005	HB179	NEW
HONDA	1100	X-ELEVEN	1999	2001	HB163		KAWASAKI	500	ER-5	1997	2005	HB179	NEW
HONDA	1100	X-ELEVEN	1999	2001	HB167		KAWASAKI	500	ER-5	1997	2005	HB180	NEW
HONDA	1100	X-ELEVEN	1999	2001	HB174		KAWASAKI	500	ER-5	1997	2005	HB180	NEW
HONDA	1100	X-ELEVEN	1999	2001	HB175		KAWASAKI	550	ZEPHYR 550	1990	1994	HB150	
HONDA	1100	X-ELEVEN	1999	2001	HB179	NEW	KAWASAKI	550	ZEPHYR 550	1990	1994	HB151	
HONDA	1100	X-ELEVEN	1999	2001	HB180	NEW	KAWASAKI	550	ZEPHYR 550	1990	1994	HB152	
HONDA	1240	VFR 1200 X CROSSTOURER	2012	2012	HB181		KAWASAKI	550	ZEPHYR 550	1990	1994	HB162	
HONDA	1240	VFR 1200 X CROSSTOURER	2012	2012	HB183	NEW	KAWASAKI	550	ZEPHYR 550	1990	1994	HB163	
HONDA	1300	CB 1300 / S	2003	2006	HB150		KAWASAKI	550	ZEPHYR 550	1990	1994	HB167	
HONDA	1300	CB 1300 / S	2003	2006	HB151		KAWASAKI	550	ZEPHYR 550	1990	1994	HB174	
HONDA	1300	CB 1300 / S	2003	2006	HB152		KAWASAKI	550	ZEPHYR 550	1990	1994	HB175	
HONDA	1300	CB 1300 / S	2003	2006	HB162		KAWASAKI	550	ZEPHYR 550	1990	1994	HB179	NEW
HONDA	1300	CB 1300 / S	2003	2006	HB163		KAWASAKI	550	ZEPHYR 550	1990	1994	HB180	NEW
HONDA	1300	CB 1300 / S	2003	2006	HB167		KAWASAKI	600	ZL 600 ELIMINATOR	1995	1997	HB150	
HONDA	1300	CB 1300 / S	2003	2006	HB174		KAWASAKI	600	ZL 600 ELIMINATOR	1995	1997	HB151	
HONDA	1300	CB 1300 / S	2003	2006	HB175		KAWASAKI	600	ZL 600 ELIMINATOR	1995	1997	HB152	
HONDA	1300	CB 1300 / S	2003	2006	HB179	NEW	KAWASAKI	600	ZL 600 ELIMINATOR	1995	1997	HB162	
HONDA	1300	CB 1300 / S	2003	2006	HB180	NEW	KAWASAKI	600	ZL 600 ELIMINATOR	1995	1997	HB163	
HONDA	900	HORNET 900	2002	2006	HB172		KAWASAKI	600	ZL 600 ELIMINATOR	1995	1997	HB167	
HUSQVARNA	450	SM 450 R	2006	2006	HB150		KAWASAKI	600	ZL 600 ELIMINATOR	1995	1997	HB174	
HUSQVARNA	450	SM 450 R	2006	2006	HB151		KAWASAKI	600	ZL 600 ELIMINATOR	1995	1997	HB175	
HUSQVARNA	450	SM 450 R	2006	2006	HB152		KAWASAKI	600	ZL 600 ELIMINATOR	1995	1997	HB179	NEW
HUSQVARNA	450	SM 450 R	2006	2006	HB162		KAWASAKI	600	ZL 600 ELIMINATOR	1995	1997	HB180	NEW
HUSQVARNA	450	SM 450 R	2006	2006	HB163		KAWASAKI	650	ER-6N	2012	2016	HB150	
HUSQVARNA	450	SM 450 R	2006	2006	HB167		KAWASAKI	650	ER-6F	2012	2016	HB150	
HUSQVARNA	450	SM 450 R	2006	2006	HB174		KAWASAKI	650	VERSYS	2010	2014	HB150	
HUSQVARNA	450	SM 450 R	2006	2006	HB175		KAWASAKI	650	ER-6N	2009	2011	HB150	
HUSQVARNA	450	SM 450 R	2006	2006	HB179	NEW	KAWASAKI	650	ER-6F	2009	2011	HB150	
HUSQVARNA	450	SM 450 R	2006	2006	HB180	NEW	KAWASAKI	650	VERSYS	2007	2009	HB150	
HUSQVARNA	900	NUDA 900 / R	2012	2012	HB181		KAWASAKI	650	ER-6N	2006	2008	HB150	
HUSQVARNA	900	NUDA 900 / R	2012	2012	HB183	NEW	KAWASAKI	650	ER-6F	2006	2008	HB150	
HYOSUNG	650	GT 650 NAKED	2005	2016	HB150		KAWASAKI	650	ER-6N	2006	2008	HB151	
HYOSUNG	650	GT 650 NAKED	2005	2016	HB151		KAWASAKI	650	ER-6F	2006	2008	HB151	
HYOSUNG	650	GT 650 NAKED	2005	2016	HB152		KAWASAKI	650	ER-6N	2009	2011	HB151	
HYOSUNG	650	GT 650 NAKED	2005	2016	HB162		KAWASAKI	650	ER-6F	2009	2011	HB151	
HYOSUNG	650	GT 650 NAKED	2005	2016	HB163		KAWASAKI	650	ER-6N	2012	2016	HB151	
HYOSUNG	650	GT 650 NAKED	2005	2016	HB175		KAWASAKI	650	ER-6F	2012	2016	HB151	
HYOSUNG	650	GT 650 NAKED	2005	2016	HB179	NEW	KAWASAKI	650	VERSYS	2007	2009	HB151	
HYOSUNG	650	GT 650 NAKED	2005	2016	HB180	NEW	KAWASAKI	650	VERSYS	2010	2014	HB151	
KAWASAKI	500	ER-5	1997	2005	HB150		KAWASAKI	650	ER-6N	2006	2008	HB152	
KAWASAKI	500	ER-5	1997	2005	HB150		KAWASAKI	650	ER-6F	2006	2008	HB152	
KAWASAKI	500	ER-5	1997	2005	HB151		KAWASAKI	650	ER-6N	2009	2011	HB152	
KAWASAKI	500	ER-5	1997	2005	HB151		KAWASAKI	650	ER-6F	2009	2011	HB152	
KAWASAKI	500	ER-5	1997	2005	HB152		KAWASAKI	650	ER-6N	2012	2016	HB152	
KAWASAKI	500	ER-5	1997	2005	HB152		KAWASAKI	650	ER-6F	2012	2016	HB152	
KAWASAKI	500	ER-5	1997	2005	HB162		KAWASAKI	650	VERSYS	2007	2009	HB152	

BRAKE/CLUTCH
MASTER CYLINDERS
 ACCESSORIES
SPARE PARTS
 CNC-WORKED FLUID
RESERVOIR
 FULL CLUTCH
 HYDRAULIC-CLUTCH
TRANFORMATION KIT
 LEVER
 THROTTLE CONTROL
 BRAKE CALIPER
 RACING KIT
 BUTTON PANEL
 LEVER GUARD
 CLIP-ON
 STREET RACING
REARSET
 FUEL CAPS
 STEERING NUT
 CRASH PADS
 PADDOCK STAND
 MIRROR COVERS
 REAR-VIEW MIRRORS
 FOG LIGHTS KIT
 HANDLEBARS
ACCESSORIES
 HANDLEBARS

Marca Brand	CC	Modello Model	Dal From	Al To	Codice Code	Novità New	Marca Brand	CC	Modello Model	Dal From	Al To	Codice Code	Novità New
KAWASAKI	650	VERSYS	2010	2014	HB152		KAWASAKI	750	Z 750 R	2011	2012	HB151	
KAWASAKI	650	ER-6N	2006	2008	HB162		KAWASAKI	750	ZR-7 / S	1999	2003	HB151	
KAWASAKI	650	ER-6F	2006	2008	HB162		KAWASAKI	750	ZEPHYR 750	1991	1994	HB151	
KAWASAKI	650	ER-6N	2009	2011	HB162		KAWASAKI	750	Z 750 / S	2004	2006	HB152	
KAWASAKI	650	ER-6F	2009	2011	HB162		KAWASAKI	750	Z 750	2007	2012	HB152	
KAWASAKI	650	ER-6N	2012	2016	HB162		KAWASAKI	750	Z 750 R	2011	2012	HB152	
KAWASAKI	650	ER-6F	2012	2016	HB162		KAWASAKI	750	ZR-7 / S	1999	2003	HB152	
KAWASAKI	650	VERSYS	2007	2009	HB162		KAWASAKI	750	ZEPHYR 750	1991	1994	HB152	
KAWASAKI	650	VERSYS	2010	2014	HB162		KAWASAKI	750	Z 750 / S	2004	2006	HB162	
KAWASAKI	650	ER-6N	2006	2008	HB163		KAWASAKI	750	Z 750	2007	2012	HB162	
KAWASAKI	650	ER-6F	2006	2008	HB163		KAWASAKI	750	Z 750 R	2011	2012	HB162	
KAWASAKI	650	ER-6N	2009	2011	HB163		KAWASAKI	750	ZR-7 / S	1999	2003	HB162	
KAWASAKI	650	ER-6F	2009	2011	HB163		KAWASAKI	750	ZEPHYR 750	1991	1994	HB162	
KAWASAKI	650	ER-6N	2012	2016	HB163		KAWASAKI	750	Z 750 / S	2004	2006	HB163	
KAWASAKI	650	ER-6F	2012	2016	HB163		KAWASAKI	750	Z 750	2007	2012	HB163	
KAWASAKI	650	VERSYS	2007	2009	HB163		KAWASAKI	750	Z 750 R	2011	2012	HB163	
KAWASAKI	650	VERSYS	2010	2014	HB163		KAWASAKI	750	ZR-7 / S	1999	2003	HB163	
KAWASAKI	650	ER-6N	2006	2008	HB167		KAWASAKI	750	ZEPHYR 750	1991	1994	HB163	
KAWASAKI	650	ER-6N	2009	2011	HB167		KAWASAKI	750	Z 750 / S	2004	2006	HB167	
KAWASAKI	650	ER-6N	2012	2016	HB167		KAWASAKI	750	Z 750	2007	2012	HB167	
KAWASAKI	650	VERSYS	2007	2009	HB167		KAWASAKI	750	Z 750 R	2011	2012	HB167	
KAWASAKI	650	VERSYS	2010	2014	HB167		KAWASAKI	750	ZR-7 / S	1999	2003	HB167	
KAWASAKI	650	ER6N	2006	2016	HB172		KAWASAKI	750	ZEPHYR 750	1991	1994	HB167	
KAWASAKI	650	ER-6N	2006	2008	HB174		KAWASAKI	750	Z750	2005	2012	HB171	
KAWASAKI	650	ER-6N	2009	2011	HB174		KAWASAKI	750	Z 750 / S	2004	2006	HB174	
KAWASAKI	650	ER-6N	2012	2016	HB174		KAWASAKI	750	Z 750	2007	2012	HB174	
KAWASAKI	650	VERSYS	2007	2009	HB174		KAWASAKI	750	Z 750 R	2011	2012	HB174	
KAWASAKI	650	VERSYS	2010	2014	HB174		KAWASAKI	750	ZR-7 / S	1999	2003	HB174	
KAWASAKI	650	ER-6N	2006	2008	HB175		KAWASAKI	750	ZEPHYR 750	1991	1994	HB174	
KAWASAKI	650	ER-6F	2006	2008	HB175		KAWASAKI	750	Z 750 / S	2004	2006	HB175	
KAWASAKI	650	ER-6N	2009	2011	HB175		KAWASAKI	750	Z 750	2007	2012	HB175	
KAWASAKI	650	ER-6F	2009	2011	HB175		KAWASAKI	750	Z 750 R	2011	2012	HB175	
KAWASAKI	650	ER-6N	2012	2016	HB175		KAWASAKI	750	ZR-7 / S	1999	2003	HB175	
KAWASAKI	650	ER-6F	2012	2016	HB175		KAWASAKI	750	ZEPHYR 750	1991	1994	HB175	
KAWASAKI	650	VERSYS	2007	2009	HB175		KAWASAKI	750	Z 750 / S	2004	2006	HB179	NEW
KAWASAKI	650	VERSYS	2010	2014	HB175		KAWASAKI	750	Z 750	2007	2012	HB179	NEW
KAWASAKI	650	ER-6N	2006	2008	HB179	NEW	KAWASAKI	750	Z 750 R	2011	2012	HB179	NEW
KAWASAKI	650	ER-6F	2006	2008	HB179	NEW	KAWASAKI	750	ZR-7 / S	1999	2003	HB179	NEW
KAWASAKI	650	ER-6N	2009	2011	HB179	NEW	KAWASAKI	750	ZEPHYR 750	1991	1994	HB179	NEW
KAWASAKI	650	ER-6F	2009	2011	HB179	NEW	KAWASAKI	750	Z 750 / S	2004	2006	HB180	NEW
KAWASAKI	650	ER-6N	2012	2016	HB179	NEW	KAWASAKI	750	ZR-7 / S	1999	2003	HB180	NEW
KAWASAKI	650	ER-6F	2012	2016	HB179	NEW	KAWASAKI	750	ZEPHYR 750	1991	1994	HB180	NEW
KAWASAKI	650	VERSYS	2007	2009	HB179	NEW	KAWASAKI	800	W 800	2011	2016	HB150	
KAWASAKI	650	VERSYS	2010	2014	HB179	NEW	KAWASAKI	800	Z 800	2013	2016	HB150	
KAWASAKI	650	ER-6N	2006	2008	HB180	NEW	KAWASAKI	800	W 800	2011	2016	HB151	
KAWASAKI	650	ER-6N	2009	2011	HB180	NEW	KAWASAKI	800	Z 800	2013	2016	HB151	
KAWASAKI	650	ER-6N	2012	2016	HB180	NEW	KAWASAKI	800	W 800	2011	2016	HB152	
KAWASAKI	650	VERSYS	2007	2009	HB180	NEW	KAWASAKI	800	Z 800	2013	2016	HB152	
KAWASAKI	650	VERSYS	2010	2014	HB180	NEW	KAWASAKI	800	W 800	2011	2016	HB162	
KAWASAKI	750	Z 750	2007	2012	HB150		KAWASAKI	800	Z 800	2013	2016	HB162	
KAWASAKI	750	Z 750 R	2011	2012	HB150		KAWASAKI	800	W 800	2011	2016	HB163	
KAWASAKI	750	Z 750 / S	2004	2006	HB150		KAWASAKI	800	Z 800	2013	2016	HB163	
KAWASAKI	750	ZR-7 / S	1999	2003	HB150		KAWASAKI	800	W 800	2011	2016	HB167	
KAWASAKI	750	ZEPHYR 750	1991	1994	HB150		KAWASAKI	800	Z 800	2013	2016	HB167	
KAWASAKI	750	Z 750 / S	2004	2006	HB151		KAWASAKI	800	W 800	2011	2016	HB174	
KAWASAKI	750	Z 750	2007	2012	HB151		KAWASAKI	800	Z 800	2013	2016	HB174	

- BRAKE/CLUTCH MASTER CYLINDERS
- ACCESSORIES SPARE PARTS
- CNC-WORKED FLUID RESERVOIR
- FULL CLUTCH
- HYDRAULIC-CLUTCH TRANFORMATION KIT
- LEVER
- THROTTLE CONTROL
- BRAKE CALIPER
- RACING KIT
- BUTTON PANEL
- LEVER GUARD
- CLIP-ON
- STREET RACING REARSET
- FUEL CAPS
- STEERING NUT
- CRASH PADS
- PADDOCK STAND
- MIRROR COVERS
- REAR-VIEW MIRRORS
- FOG LIGHTS KIT
- HANDLEBARS ACCESSORIES
- HANDLEBARS

Marca Brand	CC	Modello Model	Dal From	Al To	Codice Code	Novità New	Marca Brand	CC	Modello Model	Dal From	Al To	Codice Code	Novità New
KAWASAKI	800	W 800	2011	2016	HB175		KAWASAKI	1100	ZEPHYR 1100	1992	1995	HB163	
KAWASAKI	800	Z 800	2013	2016	HB175		KAWASAKI	1100	ZRX 1100	1997	1999	HB163	
KAWASAKI	800	W 800	2011	2016	HB179	NEW	KAWASAKI	1100	ZEPHYR 1100	1992	1995	HB167	
KAWASAKI	800	Z 800	2013	2016	HB179	NEW	KAWASAKI	1100	ZRX 1100	1997	1999	HB167	
KAWASAKI	800	W 800	2011	2016	HB180	NEW	KAWASAKI	1100	ZEPHYR 1100	1992	1995	HB174	
KAWASAKI	800	Z 800	2013	2016	HB180	NEW	KAWASAKI	1100	ZRX 1100	1997	1999	HB174	
KAWASAKI	1000	Z 1000	2010	2013	HB150		KAWASAKI	1100	ZEPHYR 1100	1992	1995	HB175	
KAWASAKI	1000	Z 1000	2007	2009	HB150		KAWASAKI	1100	ZRX 1100	1997	1999	HB175	
KAWASAKI	1000	Z 1000	2003	2006	HB150		KAWASAKI	1100	ZEPHYR 1100	1992	1995	HB179	NEW
KAWASAKI	1000	KLV 1000	2004	2005	HB150		KAWASAKI	1100	ZRX 1100	1997	1999	HB179	NEW
KAWASAKI	1000	KLV 1000	2004	2005	HB151		KAWASAKI	1100	ZEPHYR 1100	1992	1995	HB180	NEW
KAWASAKI	1000	Z 1000	2003	2006	HB151		KAWASAKI	1100	ZRX 1100	1997	1999	HB180	NEW
KAWASAKI	1000	Z 1000	2007	2009	HB151		KAWASAKI	1200	ZRX 1200 / R / S	2001	2004	HB150	
KAWASAKI	1000	Z 1000	2010	2013	HB151		KAWASAKI	1200	ZRX 1200 / R / S	2001	2004	HB151	
KAWASAKI	1000	KLV 1000	2004	2005	HB152		KAWASAKI	1200	ZRX 1200 / R / S	2001	2004	HB152	
KAWASAKI	1000	Z 1000	2003	2006	HB152		KAWASAKI	1200	ZRX 1200 / R / S	2001	2004	HB162	
KAWASAKI	1000	Z 1000	2007	2009	HB152		KAWASAKI	1200	ZRX 1200 / R / S	2001	2004	HB163	
KAWASAKI	1000	Z 1000	2010	2013	HB152		KAWASAKI	1200	ZRX 1200 / R / S	2001	2004	HB167	
KAWASAKI	1000	KLV 1000	2004	2005	HB162		KAWASAKI	1200	ZRX 1200 / R / S	2001	2004	HB174	
KAWASAKI	1000	Z 1000	2003	2006	HB162		KAWASAKI	1200	ZRX 1200 / R / S	2001	2004	HB175	
KAWASAKI	1000	Z 1000	2007	2009	HB162		KAWASAKI	1200	ZRX 1200 / R / S	2001	2004	HB179	NEW
KAWASAKI	1000	Z 1000	2010	2013	HB162		KAWASAKI	1200	ZRX 1200 / R / S	2001	2004	HB180	NEW
KAWASAKI	1000	KLV 1000	2004	2005	HB163		KAWASAKI	1300	Z 1300 DFI	1984	1989	HB150	
KAWASAKI	1000	Z 1000	2003	2006	HB163		KAWASAKI	1300	Z 1300	1980	1985	HB150	
KAWASAKI	1000	Z 1000	2007	2009	HB163		KAWASAKI	1300	Z 1300	1980	1985	HB151	
KAWASAKI	1000	Z 1000	2010	2013	HB163		KAWASAKI	1300	Z 1300 DFI	1984	1989	HB151	
KAWASAKI	1000	Z 1000	2003	2006	HB167		KAWASAKI	1300	Z 1300	1980	1985	HB152	
KAWASAKI	1000	Z 1000	2007	2009	HB167		KAWASAKI	1300	Z 1300 DFI	1984	1989	HB152	
KAWASAKI	1000	Z 1000	2010	2013	HB167		KAWASAKI	1300	Z 1300	1980	1985	HB162	
KAWASAKI	1000	Z 1000	2003	2006	HB174		KAWASAKI	1300	Z 1300 DFI	1984	1989	HB162	
KAWASAKI	1000	Z 1000	2007	2009	HB174		KAWASAKI	1300	Z 1300	1980	1985	HB163	
KAWASAKI	1000	Z 1000	2010	2013	HB174		KAWASAKI	1300	Z 1300 DFI	1984	1989	HB163	
KAWASAKI	1000	KLV 1000	2004	2005	HB175		KAWASAKI	1300	Z 1300	1980	1985	HB175	
KAWASAKI	1000	Z 1000	2003	2006	HB175		KAWASAKI	1300	Z 1300 DFI	1984	1989	HB175	
KAWASAKI	1000	Z 1000	2007	2009	HB175		KAWASAKI	1300	Z 1300	1980	1985	HB179	NEW
KAWASAKI	1000	Z 1000	2010	2013	HB175		KAWASAKI	1300	Z 1300 DFI	1984	1989	HB179	NEW
KAWASAKI	1000	KLV 1000	2004	2005	HB179	NEW	KAWASAKI	1300	Z 1300	1980	1985	HB180	NEW
KAWASAKI	1000	Z 1000	2003	2006	HB179	NEW	KAWASAKI	1300	Z 1300 DFI	1984	1989	HB180	NEW
KAWASAKI	1000	Z 1000	2007	2009	HB179	NEW	KTM	620	620 DUKE	1994	1997	HB181	
KAWASAKI	1000	Z 1000	2010	2013	HB179	NEW	KTM	620	620 DUKE	1994	1997	HB183	NEW
KAWASAKI	1000	KLV 1000	2004	2005	HB180	NEW	KTM	625	625 SXC	2002	2005	HB181	
KAWASAKI	1000	Z 1000	2003	2006	HB180	NEW	KTM	625	625 SXC	2002	2005	HB183	NEW
KAWASAKI	1000	VERSYS 1000	2012	2018	HB181		KTM	640	640 DUKE II	1996	2003	HB181	
KAWASAKI	1000	Z 1000	2010	2013	HB181		KTM	640	LC4 ADVENTURE	2003	2006	HB181	
KAWASAKI	1000	Z 1000	2014	2016	HB181		KTM	640	640 DUKE II	1996	2003	HB183	NEW
KAWASAKI	1000	VERSYS 1000	2012	2018	HB183	NEW	KTM	640	LC4 ADVENTURE	2003	2006	HB183	NEW
KAWASAKI	1000	Z 1000	2010	2013	HB183	NEW	KTM	690	690 DUKE	2007	2009	HB181	
KAWASAKI	1000	Z 1000	2014	2016	HB183	NEW	KTM	690	690 ENDURO / R	2012	2016	HB181	
KAWASAKI	1100	ZRX 1100	1997	1999	HB150		KTM	690	690 SM / SMC	2008	2011	HB181	
KAWASAKI	1100	ZEPHYR 1100	1992	1995	HB150		KTM	690	690 SUPER MOTOR / R			HB181	
KAWASAKI	1100	ZEPHYR 1100	1992	1995	HB151		KTM	690	690 DUKE	2007	2009	HB183	NEW
KAWASAKI	1100	ZRX 1100	1997	1999	HB151		KTM	690	690 ENDURO / R	2012	2016	HB183	NEW
KAWASAKI	1100	ZEPHYR 1100	1992	1995	HB152		KTM	690	690 SM / SMC	2008	2011	HB183	NEW
KAWASAKI	1100	ZRX 1100	1997	1999	HB152		KTM	690	690 SUPER MOTOR / R			HB183	NEW
KAWASAKI	1100	ZEPHYR 1100	1992	1995	HB162		KTM	950	950 ADVENTURE	2003	2006	HB181	
KAWASAKI	1100	ZRX 1100	1997	1999	HB162		KTM	950	950 DUKE			HB181	

BRAKE/CLUTCH
MASTER CYLINDERS
 ACCESSORIES
SPARE PARTS
 CNC-WORKED FLUID
RESERVOIR
 FULL CLUTCH
 HYDRAULIC-CLUTCH
TRANFORMATION KIT
 LEVER
 THROTTLE CONTROL
 BRAKE CALIPER
 RACING KIT
 BUTTON PANEL
 LEVER GUARD
 CLIP-ON
 STREET RACING
REARSET
 FUEL CAPS
 STEERING NUT
 CRASH PADS
 PADDOCK STAND
 MIRROR COVERS
 REAR-VIEW MIRRORS
 FOG LIGHTS KIT
 HANDLEBARS
ACCESSORIES
 HANDLEBARS

Marca Brand	CC	Modello Model	Dal From	Al To	Codice Code	Novità New	Marca Brand	CC	Modello Model	Dal From	Al To	Codice Code	Novità New
KTM	950	950 SUPER ENDURO / R	2006	2008	HB181		MV AGUSTA	675	BRUTALE 800	2012	2017	HB181	
KTM	950	950 SUPER MOTO / SMR			HB181		MV AGUSTA	675	BRUTALE 800	2012	2017	HB183	NEW
KTM	950	950 ADVENTURE	2003	2006	HB183	NEW	MV AGUSTA	800	RIVALE 800	2014	2016	HB181	
KTM	950	950 DUKE			HB183	NEW	MV AGUSTA	800	RIVALE 800	2014	2016	HB183	NEW
KTM	950	950 SUPER ENDURO / R	2006	2008	HB183	NEW	MV AGUSTA	989	BRUTALE 989 R	2008	2008	HB181	
KTM	950	950 SUPER MOTO / SMR			HB183	NEW	MV AGUSTA	989	BRUTALE 989 R	2008	2008	HB183	NEW
KTM	990	990 ADVENTURE / S			HB181		MV AGUSTA	1078	BRUTALE 1078 RR	2008	2008	HB181	
KTM	990	990 SUPER DUKE			HB181		MV AGUSTA	1078	BRUTALE 1078 RR	2008	2008	HB183	NEW
KTM	990	990 SUPER MOTO	2007	2008	HB181		MV AGUSTA	1090	BRUTALE 1090	2013	2015	HB181	
KTM	990	990 ADVENTURE / S			HB183	NEW	MV AGUSTA	1090	BRUTALE 1090	2013	2015	HB183	NEW
KTM	990	990 SUPER DUKE			HB183	NEW	SACHS	650	ROADSTER 650 V1	2000	2005	HB150	
KTM	990	990 SUPER MOTO	2007	2008	HB183	NEW	SACHS	650	ROADSTER 650 V1	2000	2005	HB151	
KTM	1190	1190 ADVENTURE / R	2012	2016	HB181		SACHS	650	ROADSTER 650 V1	2000	2005	HB152	
KTM	1190	1190 ADVENTURE / R	2012	2016	HB181		SACHS	650	ROADSTER 650 V1	2000	2005	HB162	
KTM	1190	1190 ADVENTURE / R	2012	2016	HB183	NEW	SACHS	650	ROADSTER 650 V1	2000	2005	HB163	
KTM	1190	1190 ADVENTURE / R	2012	2016	HB183	NEW	SACHS	650	ROADSTER 650 V1	2000	2005	HB175	
KTM	1290	1290 SUPER DUKE / R			HB181		SACHS	650	ROADSTER 650 V1	2000	2005	HB179	NEW
KTM	1290	1290 SUPER DUKE / R			HB183	NEW	SACHS	650	ROADSTER 650 V1	2000	2005	HB180	NEW
KTM	1290	1290 SUPER DUKE / R			HB183	NEW	SACHS	800	ROADSTER 800 V2	2000	2005	HB150	
KYMCO	125	MXER 150	2002	2003	HB150		SACHS	800	ROADSTER 800 V2	2000	2005	HB151	
KYMCO	125	MXER 150	2002	2003	HB151		SACHS	800	ROADSTER 800 V2	2000	2005	HB152	
KYMCO	125	MXER 150	2002	2003	HB152		SACHS	800	ROADSTER 800 V2	2000	2005	HB152	
KYMCO	125	MXER 150	2002	2003	HB162		SACHS	800	ROADSTER 800 V2	2000	2005	HB162	
KYMCO	125	MXER 150	2002	2003	HB163		SACHS	800	ROADSTER 800 V2	2000	2005	HB163	
KYMCO	125	MXER 150	2002	2003	HB175		SACHS	800	ROADSTER 800 V2	2000	2005	HB175	
KYMCO	125	MXER 150	2002	2003	HB180	NEW	SACHS	800	ROADSTER 800 V2	2000	2005	HB179	NEW
KYMCO	150	MXER 150	2002	2003	HB150		SACHS	800	ROADSTER 800 V2	2000	2005	HB180	NEW
KYMCO	150	MXER 150	2002	2003	HB151		SUZUKI	125	DR 125	1994	1995	HB150	
KYMCO	150	MXER 150	2002	2003	HB152		SUZUKI	125	DR 125	1994	1995	HB151	
KYMCO	150	MXER 150	2002	2003	HB162		SUZUKI	125	DR 125	1994	1995	HB152	
KYMCO	150	MXER 150	2002	2003	HB163		SUZUKI	125	DR 125	1994	1995	HB162	
KYMCO	150	MXER 150	2002	2003	HB175		SUZUKI	125	DR 125	1994	1995	HB163	
KYMCO	150	MXER 150	2002	2003	HB180	NEW	SUZUKI	125	DR 125	1994	1995	HB175	
KYMCO	250	KXR 250	2003	2004	HB150		SUZUKI	125	DR 125	1994	1995	HB179	NEW
KYMCO	250	KXR 250	2003	2004	HB151		SUZUKI	125	DR 125	1994	1995	HB180	NEW
KYMCO	250	KXR 250	2003	2004	HB152		SUZUKI	350	DR 350 S	1990	1994	HB150	
KYMCO	250	KXR 250	2003	2004	HB162		SUZUKI	350	DR 350 S	1990	1994	HB151	
KYMCO	250	KXR 250	2003	2004	HB163		SUZUKI	350	DR 350 S	1990	1994	HB152	
KYMCO	250	KXR 250	2003	2004	HB175		SUZUKI	350	DR 350 S	1990	1994	HB162	
KYMCO	250	KXR 250	2003	2004	HB180	NEW	SUZUKI	350	DR 350 S	1990	1994	HB163	
MOTO GUZZI	750	BREVA 750 I.E.	2003	2007	HB181		SUZUKI	350	DR 350 S	1990	1994	HB175	
MOTO GUZZI	750	BREVA 750 I.E.	2003	2007	HB183	NEW	SUZUKI	350	DR 350 S	1990	1994	HB179	NEW
MOTO GUZZI	850	BREVA 850	2006	2008	HB181		SUZUKI	350	DR 350 S	1990	1994	HB180	NEW
MOTO GUZZI	850	BREVA 850	2006	2008	HB183	NEW	SUZUKI	400	DR-Z 400 S	2000	2009	HB150	
MOTO GUZZI	1000	V11 CAFFÈ	2003	2006	HB173		SUZUKI	400	DR-Z 400 SM	2005	2009	HB150	
MOTO GUZZI	1200	GRISO 8V	2005	2016	HB181		SUZUKI	400	GSF 400 BANDIT	1991	1993	HB150	
MOTO GUZZI	1200	1200 SPORT 4V	2006	2013	HB181		SUZUKI	400	DR-Z 400 S	2000	2009	HB151	
MOTO GUZZI	1200	GRISO 8V	2005	2016	HB183	NEW	SUZUKI	400	DR-Z 400 SM	2005	2009	HB151	
MOTO GUZZI	1200	1200 SPORT 4V	2006	2013	HB183	NEW	SUZUKI	400	GSF 400 BANDIT	1991	1993	HB151	
MOTO MORINI	1200	CORSARO 1200	2006	2016	HB173		SUZUKI	400	DR-Z 400 S	2000	2009	HB152	
MOTO MORINI	1200	CORSARO 1200 VELOCE	2006	2016	HB173		SUZUKI	400	DR-Z 400 SM	2005	2009	HB152	
MOTO MORINI	1200	9 1/2	2007	2008	HB181		SUZUKI	400	GSF 400 BANDIT	1991	1993	HB152	
MOTO MORINI	1200	CORSARO/AVIO/VELOCE 1200	2005	2007	HB181		SUZUKI	400	DR-Z 400 S	2000	2009	HB162	
MOTO MORINI	1200	CORSARO VELOCE 1200	2005	2007	HB181		SUZUKI	400	DR-Z 400 SM	2005	2009	HB162	
MOTO MORINI	1200	9 1/2	2007	2008	HB183	NEW	SUZUKI	400	GSF 400 BANDIT	1991	1993	HB162	
MOTO MORINI	1200	CORSARO/AVIO/VELOCE 1200	2005	2007	HB183	NEW	SUZUKI	400	DR-Z 400 S	2000	2009	HB163	
MOTO MORINI	1200	CORSARO VELOCE 1200	2005	2007	HB183	NEW	SUZUKI	400	DR-Z 400 SM	2005	2009	HB163	

- BRAKE/CLUTCH MASTER CYLINDERS
- ACCESSORIES SPARE PARTS
- CNC-WORKED FLUID RESERVOIR
- FULL CLUTCH
- HYDRAULIC-CLUTCH TRANFORMATION KIT
- LEVER
- THROTTLE CONTROL
- BRAKE CALIPER
- RACING KIT
- BUTTON PANEL
- LEVER GUARD
- CLIP-ON
- STREET RACING REARSET
- FUEL CAPS
- STEERING NUT
- CRASH PADS
- PADDOCK STAND
- MIRROR COVERS
- REAR-VIEW MIRRORS
- FOG LIGHTS KIT
- HANDLEBARS ACCESSORIES
- HANDLEBARS

Marca Brand	CC	Modello Model	Dal From	Al To	Codice Code	Novità New	Marca Brand	CC	Modello Model	Dal From	Al To	Codice Code	Novità New
SUZUKI	400	GSF 400 BANDIT	1991	1993	HB163		SUZUKI	600	GSF 600 BANDIT/S	1995	1998	HB179	NEW
SUZUKI	400	DR-Z 400 S	2000	2009	HB175		SUZUKI	600	GSF 600 BANDIT/S	2000	2004	HB179	NEW
SUZUKI	400	DR-Z 400 SM	2005	2009	HB175		SUZUKI	600	GSR 600	2006	2010	HB180	NEW
SUZUKI	400	GSF 400 BANDIT	1991	1993	HB175		SUZUKI	600	GSF 600 BANDIT/S	1995	1998	HB180	NEW
SUZUKI	400	DR-Z 400 S	2000	2009	HB179	NEW	SUZUKI	600	GSF 600 BANDIT/S	2000	2004	HB180	NEW
SUZUKI	400	DR-Z 400 SM	2005	2009	HB179	NEW	SUZUKI	650	SV 650 N	2015	2015	HB150	
SUZUKI	400	GSF 400 BANDIT	1991	1993	HB179	NEW	SUZUKI	650	SFV 650 GLADIUS	2009	2015	HB150	
SUZUKI	400	DR-Z 400 S	2000	2009	HB180	NEW	SUZUKI	650	DL 650 V-STROM	2004	2011	HB150	
SUZUKI	400	DR-Z 400 SM	2005	2009	HB180	NEW	SUZUKI	650	GSF 650 BANDIT/S	2007	2008	HB150	
SUZUKI	400	GSF 400 BANDIT	1991	1993	HB180	NEW	SUZUKI	650	GSF 650 BANDIT/S	2005	2006	HB150	
SUZUKI	500	GS 500 F	2007	2007	HB150		SUZUKI	650	SV 650 N	1999	2002	HB150	
SUZUKI	500	GS 500 E	1989	1996	HB150		SUZUKI	650	XF 650 FREEWIND	1997	2001	HB150	
SUZUKI	500	GS 500 E	1989	1996	HB151		SUZUKI	650	DR 650	1995	1996	HB150	
SUZUKI	500	GS 500 F	2007	2007	HB151		SUZUKI	650	DR 650	1994	1995	HB150	
SUZUKI	500	GS 500 E	1989	1996	HB152		SUZUKI	650	DR 650	1991	1993	HB150	
SUZUKI	500	GS 500 F	2007	2007	HB152		SUZUKI	650	DR 650	1992	1993	HB150	
SUZUKI	500	GS 500 E	1989	1996	HB162		SUZUKI	650	DR 650	1990	1991	HB150	
SUZUKI	500	GS 500 F	2007	2007	HB162		SUZUKI	650	DR 650	1990	1991	HB150	
SUZUKI	500	GS 500 E	1989	1996	HB163		SUZUKI	650	GSF 650 BANDIT/S	2005	2006	HB151	
SUZUKI	500	GS 500 F	2007	2007	HB163		SUZUKI	650	GSF 650 BANDIT/S	2007	2008	HB151	
SUZUKI	500	GS 500 E	1989	1996	HB167		SUZUKI	650	DL 650 V-STROM	2004	2011	HB151	
SUZUKI	500	GS 500 F	2007	2007	HB167		SUZUKI	650	DR 650	1990	1991	HB151	
SUZUKI	500	GS 500 E	1989	1996	HB174		SUZUKI	650	DR 650	1990	1991	HB151	
SUZUKI	500	GS 500 F	2007	2007	HB174		SUZUKI	650	DR 650	1991	1993	HB151	
SUZUKI	500	GS 500 E	1989	1996	HB175		SUZUKI	650	DR 650	1992	1993	HB151	
SUZUKI	500	GS 500 F	2007	2007	HB175		SUZUKI	650	DR 650	1994	1995	HB151	
SUZUKI	500	GS 500 E	1989	1996	HB179	NEW	SUZUKI	650	DR 650	1995	1996	HB151	
SUZUKI	500	GS 500 F	2007	2007	HB179	NEW	SUZUKI	650	SV 650 N	1999	2002	HB151	
SUZUKI	500	GS 500 E	1989	1996	HB180	NEW	SUZUKI	650	SV 650 N	2015	2015	HB151	
SUZUKI	500	GS 500 F	2007	2007	HB180	NEW	SUZUKI	650	SFV 650 GLADIUS	2009	2015	HB151	
SUZUKI	600	GSR 600	2006	2010	HB150		SUZUKI	650	XF 650 FREEWIND	1997	2001	HB151	
SUZUKI	600	GSF 600 BANDIT/S	2000	2004	HB150		SUZUKI	650	GSF 650 BANDIT/S	2005	2006	HB152	
SUZUKI	600	GSF 600 BANDIT/S	1995	1998	HB150		SUZUKI	650	GSF 650 BANDIT/S	2007	2008	HB152	
SUZUKI	600	GSR 600	2006	2010	HB151		SUZUKI	650	DL 650 V-STROM	2004	2011	HB152	
SUZUKI	600	GSF 600 BANDIT/S	1995	1998	HB151		SUZUKI	650	DR 650	1990	1991	HB152	
SUZUKI	600	GSF 600 BANDIT/S	2000	2004	HB151		SUZUKI	650	DR 650	1990	1991	HB152	
SUZUKI	600	GSR 600	2006	2010	HB152		SUZUKI	650	DR 650	1991	1993	HB152	
SUZUKI	600	GSF 600 BANDIT/S	1995	1998	HB152		SUZUKI	650	DR 650	1992	1993	HB152	
SUZUKI	600	GSF 600 BANDIT/S	2000	2004	HB152		SUZUKI	650	DR 650	1994	1995	HB152	
SUZUKI	600	GSR 600	2006	2010	HB162		SUZUKI	650	DR 650	1995	1996	HB152	
SUZUKI	600	GSF 600 BANDIT/S	1995	1998	HB162		SUZUKI	650	SV 650 N	1999	2002	HB152	
SUZUKI	600	GSF 600 BANDIT/S	2000	2004	HB162		SUZUKI	650	SV 650 N	2015	2015	HB152	
SUZUKI	600	GSR 600	2006	2010	HB163		SUZUKI	650	SFV 650 GLADIUS	2009	2015	HB152	
SUZUKI	600	GSF 600 BANDIT/S	1995	1998	HB163		SUZUKI	650	XF 650 FREEWIND	1997	2001	HB152	
SUZUKI	600	GSF 600 BANDIT/S	2000	2004	HB163		SUZUKI	650	GSF 650 BANDIT/S	2005	2006	HB162	
SUZUKI	600	GSR 600	2006	2010	HB167		SUZUKI	650	GSF 650 BANDIT/S	2007	2008	HB162	
SUZUKI	600	GSF 600 BANDIT/S	1995	1998	HB167		SUZUKI	650	DL 650 V-STROM	2004	2011	HB162	
SUZUKI	600	GSF 600 BANDIT/S	2000	2004	HB167		SUZUKI	650	DR 650	1990	1991	HB162	
SUZUKI	600	GSR600	2006	2010	HB172		SUZUKI	650	DR 650	1990	1991	HB162	
SUZUKI	600	GSR 600	2006	2010	HB174		SUZUKI	650	DR 650	1991	1993	HB162	
SUZUKI	600	GSF 600 BANDIT/S	1995	1998	HB174		SUZUKI	650	DR 650	1992	1993	HB162	
SUZUKI	600	GSF 600 BANDIT/S	2000	2004	HB174		SUZUKI	650	DR 650	1994	1995	HB162	
SUZUKI	600	GSR 600	2006	2010	HB175		SUZUKI	650	DR 650	1995	1996	HB162	
SUZUKI	600	GSF 600 BANDIT/S	1995	1998	HB175		SUZUKI	650	SV 650 N	1999	2002	HB162	
SUZUKI	600	GSF 600 BANDIT/S	2000	2004	HB175		SUZUKI	650	SV 650 N	2015	2015	HB162	
SUZUKI	600	GSR 600	2006	2010	HB179	NEW	SUZUKI	650	SFV 650 GLADIUS	2009	2015	HB162	

BRAKE/CLUTCH
 MASTER CYLINDERS
 ACCESSORIES
 SPARE PARTS
 CNC-WORKED FLUID
 RESERVOIR
 FULL CLUTCH
 HYDRAULIC-CLUTCH
 TRANFORMATION KIT
 LEVER
 THROTTLE CONTROL
 BRAKE CALIPER
 RACING KIT
 BUTTON PANEL
 LEVER GUARD
 CLIP-ON
 STREET RACING
 REARSET
 FUEL CAPS
 STEERING NUT
 CRASH PADS
 PADDOCK STAND
 MIRROR COVERS
 REAR-VIEW MIRRORS
 FOG LIGHTS KIT
 HANDLEBARS
 ACCESSORIES
 HANDLEBARS

Marca Brand	CC	Modello Model	Dal From	Al To	Codice Code	Novità New	Marca Brand	CC	Modello Model	Dal From	Al To	Codice Code	Novità New
SUZUKI	650	XF 650 FREEWIND	1997	2001	HB162		SUZUKI	650	GSF 650 BANDIT/S	2005	2006	HB180	NEW
SUZUKI	650	GSF 650 BANDIT/S	2005	2006	HB163		SUZUKI	650	GSF 650 BANDIT/S	2007	2008	HB180	NEW
SUZUKI	650	GSF 650 BANDIT/S	2007	2008	HB163		SUZUKI	650	DL 650 V-STROM	2004	2011	HB180	NEW
SUZUKI	650	DL 650 V-STROM	2004	2011	HB163		SUZUKI	650	DR 650	1990	1991	HB180	NEW
SUZUKI	650	DR 650	1990	1991	HB163		SUZUKI	650	DR 650	1990	1991	HB180	NEW
SUZUKI	650	DR 650	1990	1991	HB163		SUZUKI	650	DR 650	1991	1993	HB180	NEW
SUZUKI	650	DR 650	1991	1993	HB163		SUZUKI	650	DR 650	1992	1993	HB180	NEW
SUZUKI	650	DR 650	1992	1993	HB163		SUZUKI	650	DR 650	1994	1995	HB180	NEW
SUZUKI	650	DR 650	1994	1995	HB163		SUZUKI	650	DR 650	1995	1996	HB180	NEW
SUZUKI	650	DR 650	1995	1996	HB163		SUZUKI	650	SV 650 N	1999	2002	HB180	NEW
SUZUKI	650	SV 650 N	1999	2002	HB163		SUZUKI	650	SV 650 N	2015	2015	HB180	NEW
SUZUKI	650	SV 650 N	2015	2015	HB163		SUZUKI	650	XF 650 FREEWIND	1997	2001	HB180	NEW
SUZUKI	650	SFV 650 GLADIUS	2009	2015	HB163		SUZUKI	750	GSX 750	2011	2016	HB150	
SUZUKI	650	SFV 650 GLADIUS	2009	2015	HB163		SUZUKI	750	GSX 750	1999	2001	HB150	
SUZUKI	650	XF 650 FREEWIND	1997	2001	HB163		SUZUKI	750	GSX 750	1999	2001	HB151	
SUZUKI	650	SV 650	2003	2010	HB164		SUZUKI	750	GSX 750	2011	2016	HB151	
SUZUKI	650	SV 650	2003	2010	HB165		SUZUKI	750	GSX 750	1999	2001	HB152	
SUZUKI	650	SV 650	2003	2010	HB166		SUZUKI	750	GSX 750	2011	2016	HB152	
SUZUKI	650	GSF 650 BANDIT/S	2005	2006	HB167		SUZUKI	750	GSX 750	1999	2001	HB162	
SUZUKI	650	GSF 650 BANDIT/S	2007	2008	HB167		SUZUKI	750	GSX 750	2011	2016	HB162	
SUZUKI	650	DL 650 V-STROM	2004	2011	HB167		SUZUKI	750	GSX 750	1999	2001	HB163	
SUZUKI	650	SV 650 N	1999	2002	HB167		SUZUKI	750	GSX 750	2011	2016	HB163	
SUZUKI	650	SV 650 N	2015	2015	HB167		SUZUKI	750	GSX 750	1999	2001	HB167	
SUZUKI	650	SFV 650 GLADIUS	2009	2015	HB167		SUZUKI	750	GSX 750	2011	2016	HB167	
SUZUKI	650	SV650S	2015	2015	HB171		SUZUKI	750	GSX 750	2011	2016	HB174	
SUZUKI	650	GSF 650 BANDIT/S	2005	2006	HB174		SUZUKI	750	GSX 750	1999	2001	HB175	
SUZUKI	650	GSF 650 BANDIT/S	2007	2008	HB174		SUZUKI	750	GSX 750	2011	2016	HB175	
SUZUKI	650	DL 650 V-STROM	2004	2011	HB174		SUZUKI	750	GSX 750	1999	2001	HB175	
SUZUKI	650	SV 650 N	1999	2002	HB174		SUZUKI	750	GSX 750	2011	2016	HB179	NEW
SUZUKI	650	SV 650 N	2015	2015	HB174		SUZUKI	750	GSX 750	1999	2001	HB179	NEW
SUZUKI	650	SV 650 N	2015	2015	HB174		SUZUKI	750	GSX 750	2011	2016	HB179	NEW
SUZUKI	650	SFV 650 GLADIUS	2009	2015	HB174		SUZUKI	750	GSX 750	2011	2016	HB180	NEW
SUZUKI	650	GSF 650 BANDIT/S	2005	2006	HB175		SUZUKI	800	DR 800	1991	1993	HB150	
SUZUKI	650	GSF 650 BANDIT/S	2007	2008	HB175		SUZUKI	800	DR 800	1991	1993	HB150	
SUZUKI	650	DL 650 V-STROM	2004	2011	HB175		SUZUKI	800	DR 800	1991	1993	HB151	
SUZUKI	650	DR 650	1990	1991	HB175		SUZUKI	800	DR 800	1991	1993	HB151	
SUZUKI	650	DR 650	1990	1991	HB175		SUZUKI	800	DR 800	1991	1993	HB152	
SUZUKI	650	DR 650	1991	1993	HB175		SUZUKI	800	DR 800	1991	1993	HB152	
SUZUKI	650	DR 650	1992	1993	HB175		SUZUKI	800	DR 800	1991	1993	HB162	
SUZUKI	650	DR 650	1994	1995	HB175		SUZUKI	800	DR 800	1991	1993	HB162	
SUZUKI	650	DR 650	1995	1996	HB175		SUZUKI	800	DR 800	1991	1993	HB163	
SUZUKI	650	SV 650 N	1999	2002	HB175		SUZUKI	800	DR 800	1991	1993	HB163	
SUZUKI	650	SV 650 N	2015	2015	HB175		SUZUKI	800	DR 800	1991	1993	HB175	
SUZUKI	650	SV 650 N	2015	2015	HB175		SUZUKI	800	DR 800	1991	1993	HB175	
SUZUKI	650	SFV 650 GLADIUS	2009	2015	HB175		SUZUKI	800	DR 800	1991	1993	HB175	
SUZUKI	650	XF 650 FREEWIND	1997	2001	HB175		SUZUKI	800	DR 800	1991	1993	HB179	NEW
SUZUKI	650	GSF 650 BANDIT/S	2005	2006	HB179	NEW	SUZUKI	800	DR 800	1991	1993	HB179	NEW
SUZUKI	650	GSF 650 BANDIT/S	2007	2008	HB179	NEW	SUZUKI	800	DR 800	1991	1993	HB180	NEW
SUZUKI	650	DL 650 V-STROM	2004	2011	HB179	NEW	SUZUKI	800	DR 800	1991	1993	HB180	NEW
SUZUKI	650	DR 650	1990	1991	HB179	NEW	SUZUKI	1000	DL 1000 V-STROM	2002	2010	HB150	
SUZUKI	650	DR 650	1990	1991	HB179	NEW	SUZUKI	1000	SV 1000 N	2003	2007	HB150	
SUZUKI	650	DR 650	1991	1993	HB179	NEW	SUZUKI	1000	DL 1000 V-STROM	2002	2010	HB151	
SUZUKI	650	DR 650	1992	1993	HB179	NEW	SUZUKI	1000	SV 1000 N	2003	2007	HB151	
SUZUKI	650	DR 650	1994	1995	HB179	NEW	SUZUKI	1000	DL 1000 V-STROM	2002	2010	HB152	
SUZUKI	650	DR 650	1995	1996	HB179	NEW	SUZUKI	1000	SV 1000 N	2003	2007	HB152	
SUZUKI	650	DR 650	1995	1996	HB179	NEW	SUZUKI	1000	DL 1000 V-STROM	2002	2010	HB162	
SUZUKI	650	SV 650 N	1999	2002	HB179	NEW	SUZUKI	1000	SV 1000 N	2003	2007	HB162	
SUZUKI	650	SV 650 N	2015	2015	HB179	NEW	SUZUKI	1000	DL 1000 V-STROM	2002	2010	HB163	
SUZUKI	650	SFV 650 GLADIUS	2009	2015	HB179	NEW	SUZUKI	1000	SV 1000 N	2003	2007	HB163	
SUZUKI	650	XF 650 FREEWIND	1997	2001	HB179	NEW	SUZUKI	1000	SV 1000 N	2003	2007	HB163	

- BRAKE/CLUTCH MASTER CYLINDERS
- ACCESSORIES SPARE PARTS
- CNC-WORKED FLUID RESERVOIR
- FULL CLUTCH
- HYDRAULIC-CLUTCH TRANFORMATION KIT
- LEVER
- THROTTLE CONTROL
- BRAKE CALIPER
- RACING KIT
- BUTTON PANEL
- LEVER GUARD
- CLIP-ON
- STREET RACING REARSET
- FUEL CAPS
- STEERING NUT
- CRASH PADS
- PADDOCK STAND
- MIRROR COVERS
- REAR-VIEW MIRRORS
- FOG LIGHTS KIT
- HANDLEBARS ACCESSORIES
- HANDLEBARS

Marca Brand	CC	Modello Model	Dal From	Al To	Codice Code	Novità New	Marca Brand	CC	Modello Model	Dal From	Al To	Codice Code	Novità New
SUZUKI	1000	DL 1000 V-STROM	2002	2010	HB167		SUZUKI	1200	GSF 1200 BANDIT/S	2006	2006	HB179	NEW
SUZUKI	1000	SV 1000 N	2003	2007	HB167		SUZUKI	1200	GSX 1200 INAZUMA	1999	2001	HB179	NEW
SUZUKI	1000	DL 1000 V-STROM	2002	2010	HB174		SUZUKI	1200	GSF 1200 BANDIT/S	1996	2000	HB180	NEW
SUZUKI	1000	SV 1000 N	2003	2007	HB174		SUZUKI	1200	GSF 1200 BANDIT/S	2001	2005	HB180	NEW
SUZUKI	1000	DL 1000 V-STROM	2002	2010	HB175		SUZUKI	1200	GSF 1200 BANDIT/S	2006	2006	HB180	NEW
SUZUKI	1000	SV 1000 N	2003	2007	HB175		SUZUKI	1200	GSX 1200 INAZUMA	1999	2001	HB180	NEW
SUZUKI	1000	DL 1000 V-STROM	2002	2010	HB179	NEW	SUZUKI	1250	GSF 1250 BANDIT/S/F	2007	2010	HB150	
SUZUKI	1000	SV 1000 N	2003	2007	HB179	NEW	SUZUKI	1250	GSF 1250 BANDIT/S/F	2007	2010	HB151	
SUZUKI	1000	DL 1000 V-STROM	2002	2010	HB180	NEW	SUZUKI	1250	GSF 1250 BANDIT/S/F	2007	2010	HB152	
SUZUKI	1000	SV 1000 N	2003	2007	HB180	NEW	SUZUKI	1250	GSF 1250 BANDIT/S/F	2007	2010	HB162	
SUZUKI	1000	V-STROM 1000	2014	2016	HB181	NEW	SUZUKI	1250	GSF 1250 BANDIT/S/F	2007	2010	HB163	
SUZUKI	1000	V-STROM 1000	2014	2016	HB183	NEW	SUZUKI	1250	GSF 1250 BANDIT/S/F	2007	2010	HB167	
SUZUKI	1100	GSX 1100 G	1986	1988	HB150		SUZUKI	1250	GSF 1250 BANDIT/S/F	2007	2010	HB174	
SUZUKI	1100	GSX 1100 G	1986	1988	HB151		SUZUKI	1250	GSF 1250 BANDIT/S/F	2007	2010	HB175	
SUZUKI	1100	GSX 1100 G	1986	1988	HB152		SUZUKI	1250	GSF 1250 BANDIT/S/F	2007	2010	HB179	NEW
SUZUKI	1100	GSX 1100 G	1986	1988	HB162		SUZUKI	1250	GSF 1250 BANDIT/S/F	2007	2010	HB180	NEW
SUZUKI	1100	GSX 1100 G	1986	1988	HB163		SUZUKI	1300	B-KING	2008	2010	HB150	
SUZUKI	1100	GSX 1100 G	1986	1988	HB167		SUZUKI	1300	B-KING	2008	2010	HB151	
SUZUKI	1100	GSX 1100 G	1986	1988	HB174		SUZUKI	1300	B-KING	2008	2010	HB152	
SUZUKI	1100	GSX 1100 G	1986	1988	HB175		SUZUKI	1300	B-KING	2008	2010	HB162	
SUZUKI	1100	GSX 1100 G	1986	1988	HB179	NEW	SUZUKI	1300	B-KING	2008	2010	HB163	
SUZUKI	1100	GSX 1100 G	1986	1988	HB180	NEW	SUZUKI	1300	B-KING	2008	2010	HB167	
SUZUKI	1200	GSF 1200 BANDIT/S	2006	2006	HB150		SUZUKI	1300	B-KING	2008	2010	HB174	
SUZUKI	1200	GSF 1200 BANDIT/S	2001	2005	HB150		SUZUKI	1300	B-KING	2008	2010	HB175	
SUZUKI	1200	GSX 1200 INAZUMA	1999	2001	HB150		SUZUKI	1300	B-KING	2008	2010	HB179	NEW
SUZUKI	1200	GSF 1200 BANDIT/S	1996	2000	HB150		SUZUKI	1300	B-KING	2008	2010	HB180	NEW
SUZUKI	1200	GSF 1200 BANDIT/S	1996	2000	HB151		SUZUKI	1400	GSX 1400	2002	2007	HB150	
SUZUKI	1200	GSF 1200 BANDIT/S	2001	2005	HB151		SUZUKI	1400	GSX 1400	2002	2007	HB151	
SUZUKI	1200	GSF 1200 BANDIT/S	2006	2006	HB151		SUZUKI	1400	GSX 1400	2002	2007	HB152	
SUZUKI	1200	GSX 1200 INAZUMA	1999	2001	HB151		SUZUKI	1400	GSX 1400	2002	2007	HB162	
SUZUKI	1200	GSF 1200 BANDIT/S	1996	2000	HB152		SUZUKI	1400	GSX 1400	2002	2007	HB163	
SUZUKI	1200	GSF 1200 BANDIT/S	2001	2005	HB152		SUZUKI	1400	GSX 1400	2002	2007	HB167	
SUZUKI	1200	GSF 1200 BANDIT/S	2006	2006	HB152		SUZUKI	1400	GSX 1400	2002	2007	HB174	
SUZUKI	1200	GSX 1200 INAZUMA	1999	2001	HB152		SUZUKI	1400	GSX 1400	2002	2007	HB175	
SUZUKI	1200	GSF 1200 BANDIT/S	1996	2000	HB162		SUZUKI	1400	GSX 1400	2002	2007	HB179	NEW
SUZUKI	1200	GSF 1200 BANDIT/S	2001	2005	HB162		SUZUKI	1400	GSX 1400	2002	2007	HB180	NEW
SUZUKI	1200	GSF 1200 BANDIT/S	2006	2006	HB162		TRIUMPH	600	SPEED FOUR	2004	2006	HB150	
SUZUKI	1200	GSX 1200 INAZUMA	1999	2001	HB162		TRIUMPH	600	SPEED FOUR	2004	2006	HB151	
SUZUKI	1200	GSF 1200 BANDIT/S	1996	2000	HB163		TRIUMPH	600	SPEED FOUR	2004	2006	HB152	
SUZUKI	1200	GSF 1200 BANDIT/S	2001	2005	HB163		TRIUMPH	600	SPEED FOUR	2004	2006	HB162	
SUZUKI	1200	GSF 1200 BANDIT/S	2006	2006	HB163		TRIUMPH	600	SPEED FOUR	2004	2006	HB163	
SUZUKI	1200	GSX 1200 INAZUMA	1999	2001	HB163		TRIUMPH	600	SPEED FOUR	2004	2006	HB167	
SUZUKI	1200	GSF 1200 BANDIT/S	1996	2000	HB167		TRIUMPH	600	SPEED FOUR	2004	2006	HB175	
SUZUKI	1200	GSF 1200 BANDIT/S	2001	2005	HB167		TRIUMPH	600	SPEED FOUR	2004	2006	HB179	NEW
SUZUKI	1200	GSF 1200 BANDIT/S	2006	2006	HB167		TRIUMPH	675	DAYTONA 675	2006	2008	HB150	
SUZUKI	1200	GSX 1200 INAZUMA	1999	2001	HB167		TRIUMPH	675	DAYTONA 675	2006	2008	HB151	
SUZUKI	1200	GSF 1200 BANDIT/S	1996	2000	HB174		TRIUMPH	675	DAYTONA 675	2006	2008	HB152	
SUZUKI	1200	GSF 1200 BANDIT/S	2001	2005	HB174		TRIUMPH	675	DAYTONA 675	2006	2008	HB162	
SUZUKI	1200	GSF 1200 BANDIT/S	2006	2006	HB174		TRIUMPH	675	DAYTONA 675	2006	2008	HB163	
SUZUKI	1200	GSX 1200 INAZUMA	1999	2001	HB174		TRIUMPH	675	DAYTONA 675	2006	2008	HB167	
SUZUKI	1200	GSF 1200 BANDIT/S	1996	2000	HB175		TRIUMPH	675	DAYTONA 675	2006	2008	HB175	
SUZUKI	1200	GSF 1200 BANDIT/S	2001	2005	HB175		TRIUMPH	675	DAYTONA 675	2006	2008	HB179	NEW
SUZUKI	1200	GSF 1200 BANDIT/S	2006	2006	HB175		TRIUMPH	675	DAYTONA 675	2006	2008	HB181	
SUZUKI	1200	GSX 1200 INAZUMA	1999	2001	HB175		TRIUMPH	675	DAYTONA 675	2006	2008	HB183	NEW
SUZUKI	1200	GSF 1200 BANDIT/S	1996	2000	HB179	NEW	TRIUMPH	800	BONNEVILLE	2001	2014	HB150	
SUZUKI	1200	GSF 1200 BANDIT/S	2001	2005	HB179	NEW	TRIUMPH	800	BONNEVILLE	2001	2014	HB151	

BRAKE/CLUTCH
 MASTER CYLINDERS
 ACCESSORIES
 SPARE PARTS
 CNC-WORKED FLUID
 RESERVOIR
 FULL CLUTCH
 HYDRAULIC-CLUTCH
 TRANFORMATION KIT
 LEVER
 THROTTLE CONTROL
 BRAKE CALIPER
 RACING KIT
 BUTTON PANEL
 LEVER GUARD
 CLIP-ON
 STREET RACING
 REARSET
 FUEL CAPS
 STEERING NUT
 CRASH PADS
 PADDOCK STAND
 MIRROR COVERS
 REAR-VIEW MIRRORS
 FOG LIGHTS KIT
 HANDLEBARS
 ACCESSORIES
 HANDLEBARS

Marca Brand	CC	Modello Model	Dal From	Al To	Codice Code	Novità New	Marca Brand	CC	Modello Model	Dal From	Al To	Codice Code	Novità New
TRIUMPH	955	SPEED TRIPLE 955I	1997	2004	HB175		YAMAHA	125	TDR 125	1989	1994	HB163	
TRIUMPH	955	TIGER 955	2004	2006	HB175		YAMAHA	125	TDR 125	1989	1994	HB175	
TRIUMPH	955	SPEED TRIPLE 955I	1997	2004	HB179	NEW	YAMAHA	125	TDR 125	1989	1994	HB179	NEW
TRIUMPH	955	TIGER 955	2004	2006	HB179	NEW	YAMAHA	125	TDR 125	1989	1994	HB180	NEW
TRIUMPH	955	SPEED TRIPLE 955I	1997	2004	HB180	NEW	YAMAHA	400	XS 400	1977	1990	HB150	
TRIUMPH	955	TIGER 955	2004	2006	HB180	NEW	YAMAHA	400	XS 400	1977	1990	HB151	
TRIUMPH	1050	SPEED TRIPLE 1050	1993	2017	HB150		YAMAHA	400	XS 400	1977	1990	HB152	
TRIUMPH	1050	TIGER 1050	2006	2008	HB150		YAMAHA	400	XS 400	1977	1990	HB162	
TRIUMPH	1050	SPEED TRIPLE 1050	1993	2017	HB151		YAMAHA	400	XS 400	1977	1990	HB163	
TRIUMPH	1050	TIGER 1050	2006	2008	HB151		YAMAHA	400	XS 400	1977	1990	HB167	
TRIUMPH	1050	SPEED TRIPLE 1050	1993	2017	HB152		YAMAHA	400	XS 400	1977	1990	HB174	
TRIUMPH	1050	TIGER 1050	2006	2008	HB152		YAMAHA	400	XS 400	1977	1990	HB175	
TRIUMPH	1050	SPEED TRIPLE 1050	1993	2017	HB162		YAMAHA	400	XS 400	1977	1990	HB179	NEW
TRIUMPH	1050	TIGER 1050	2006	2008	HB162		YAMAHA	400	XS 400	1977	1990	HB180	NEW
TRIUMPH	1050	SPEED TRIPLE 1050	1993	2017	HB163		YAMAHA	500	SR 500	1978	1999	HB150	
TRIUMPH	1050	TIGER 1050	2006	2008	HB163		YAMAHA	500	SR 500	1978	1999	HB150	
TRIUMPH	1050	SPEED TRIPLE 1050	1993	2017	HB167		YAMAHA	500	SR 500	1978	1999	HB151	
TRIUMPH	1050	TIGER 1050	2006	2008	HB167		YAMAHA	500	SR 500	1978	1999	HB151	
TRIUMPH	1050	SPEED TRIPLE 1050	1993	2017	HB174		YAMAHA	500	SR 500	1978	1999	HB152	
TRIUMPH	1050	TIGER 1050	2006	2008	HB174		YAMAHA	500	SR 500	1978	1999	HB152	
TRIUMPH	1050	SPEED TRIPLE 1050	1993	2017	HB175		YAMAHA	500	SR 500	1978	1999	HB162	
TRIUMPH	1050	TIGER 1050	2006	2008	HB175		YAMAHA	500	SR 500	1978	1999	HB162	
TRIUMPH	1050	SPEED TRIPLE 1050	1993	2017	HB179	NEW	YAMAHA	500	SR 500	1978	1999	HB163	
TRIUMPH	1050	TIGER 1050	2006	2008	HB179	NEW	YAMAHA	500	SR 500	1978	1999	HB163	
TRIUMPH	1050	SPEED TRIPLE 1050	1993	2017	HB180	NEW	YAMAHA	500	SR 500	1978	1999	HB167	
TRIUMPH	1050	TIGER 1050	2006	2008	HB180	NEW	YAMAHA	500	SR 500	1978	1999	HB167	
TRIUMPH	1050	SPEED TRIPLE 1050	1993	2017	HB181		YAMAHA	500	SR 500	1978	1999	HB174	
TRIUMPH	1050	TIGER 1050	2006	2008	HB181		YAMAHA	500	SR 500	1978	1999	HB174	
TRIUMPH	1050	STREET TRIPLE / R	2011		HB181		YAMAHA	500	SR 500	1978	1999	HB174	
TRIUMPH	1050	SPEED TRIPLE 1050	1993	2017	HB183	NEW	YAMAHA	500	SR 500	1978	1999	HB175	
TRIUMPH	1050	STREET TRIPLE / R	2011		HB183	NEW	YAMAHA	500	SR 500	1978	1999	HB175	
TRIUMPH	1200	TROPHY 1200	2013	2013	HB150		YAMAHA	500	SR 500	1978	1999	HB179	NEW
TRIUMPH	1200	TROPHY 1200	2013	2013	HB150		YAMAHA	500	SR 500	1978	1999	HB179	NEW
TRIUMPH	1200	TROPHY 1200	2013	2013	HB151		YAMAHA	500	SR 500	1978	1999	HB180	NEW
TRIUMPH	1200	TROPHY 1200	2013	2013	HB151		YAMAHA	500	SR 500	1978	1999	HB180	NEW
TRIUMPH	1200	TROPHY 1200	2013	2013	HB152		YAMAHA	600	XJ 6 / DIVERSION / SP	2009	2015	HB150	
TRIUMPH	1200	TROPHY 1200	2013	2013	HB152		YAMAHA	600	FZ 6/FAZER/S2	2007	2008	HB150	
TRIUMPH	1200	TROPHY 1200	2013	2013	HB162		YAMAHA	600	FZ 6/FAZER	2004	2007	HB150	
TRIUMPH	1200	TROPHY 1200	2013	2013	HB162		YAMAHA	600	FZS 600 FAZER	2001	2002	HB150	
TRIUMPH	1200	TROPHY 1200	2013	2013	HB163		YAMAHA	600	XJ 600 N/S	1999	2002	HB150	
TRIUMPH	1200	TROPHY 1200	2013	2013	HB163		YAMAHA	600	XJ 600 N/S	1999	2002	HB150	
TRIUMPH	1200	TROPHY 1200	2013	2013	HB167		YAMAHA	600	XJ 600 N/S	1995	1997	HB150	
TRIUMPH	1200	TROPHY 1200	2013	2013	HB167		YAMAHA	600	XJ 600 N/S	1996	1996	HB150	
TRIUMPH	1200	TROPHY 1200	2013	2013	HB174		YAMAHA	600	XJ 600 N/S	1993	1996	HB150	
TRIUMPH	1200	TROPHY 1200	2013	2013	HB174		YAMAHA	600	XJ 600 N/S	1993	1996	HB150	
TRIUMPH	1200	TROPHY 1200	2013	2013	HB175		YAMAHA	600	FZS 600 FAZER	2001	2002	HB151	
TRIUMPH	1200	TROPHY 1200	2013	2013	HB175		YAMAHA	600	FZ 6/FAZER	2004	2007	HB151	
TRIUMPH	1200	TROPHY 1200	2013	2013	HB175		YAMAHA	600	FZ 6/FAZER/S2	2007	2008	HB151	
TRIUMPH	1200	TROPHY 1200	2013	2013	HB179	NEW	YAMAHA	600	XJ 6 / DIVERSION / SP	2009	2015	HB151	
TRIUMPH	1200	TROPHY 1200	2013	2013	HB179	NEW	YAMAHA	600	XJ 600 N/S	1995	1997	HB151	
TRIUMPH	1200	TROPHY 1200	2013	2013	HB180	NEW	YAMAHA	600	XJ 600 N/S	1996	1996	HB151	
TRIUMPH	1200	TROPHY 1200	2013	2013	HB180	NEW	YAMAHA	600	XJ 600 N/S	1993	1996	HB151	
TRIUMPH	1200	TIGER EXPLORER	2012	2016	HB181		YAMAHA	600	XJ 600 N/S	1999	2002	HB151	
TRIUMPH	1200	TIGER EXPLORER	2012	2016	HB183	NEW	YAMAHA	600	XJ 600 N/S	1999	2002	HB151	
YAMAHA	125	TDR 125	1989	1994	HB150		YAMAHA	600	FZS 600 FAZER	2001	2002	HB152	
YAMAHA	125	TDR 125	1989	1994	HB151		YAMAHA	600	FZ 6/FAZER	2004	2007	HB152	
YAMAHA	125	TDR 125	1989	1994	HB152		YAMAHA	600	FZ 6/FAZER/S2	2007	2008	HB152	
YAMAHA	125	TDR 125	1989	1994	HB162		YAMAHA	600	XJ 6 / DIVERSION / SP	2009	2015	HB152	

BRAKE/CLUTCH
MASTER CYLINDERS
 ACCESSORIES
SPARE PARTS
 CNC-WORKED FLUID
RESERVOIR
 FULL CLUTCH
 HYDRAULIC-CLUTCH
TRANFORMATION KIT
 LEVER
 THROTTLE CONTROL
 BRAKE CALIPER
 RACING KIT
 BUTTON PANEL
 LEVER GUARD
 CLIP-ON
 STREET RACING
REARSET
 FUEL CAPS
 STEERING NUT
 CRASH PADS
 PADDOCK STAND
 MIRROR COVERS
 REAR-VIEW MIRRORS
 FOG LIGHTS KIT
 HANDLEBARS
ACCESSORIES
 HANDLEBARS

Marca Brand	CC	Modello Model	Dal From	Al To	Codice Code	Novità New	Marca Brand	CC	Modello Model	Dal From	Al To	Codice Code	Novità New
YAMAHA	600	XJ 600 N/S	1995	1997	HB152		YAMAHA	600	XJ 600 N/S	1996	1996	HB179	NEW
YAMAHA	600	XJ 600 N/S	1996	1996	HB152		YAMAHA	600	XJ 600 N/S	1993	1996	HB179	NEW
YAMAHA	600	XJ 600 N/S	1993	1996	HB152		YAMAHA	600	XJ 600 N/S	1999	2002	HB179	NEW
YAMAHA	600	XJ 600 N/S	1999	2002	HB152		YAMAHA	600	XJ 600 N/S	1999	2002	HB179	NEW
YAMAHA	600	XJ 600 N/S	1999	2002	HB152		YAMAHA	600	FZS 600 FAZER	2001	2002	HB180	NEW
YAMAHA	600	FZS 600 FAZER	2001	2002	HB162		YAMAHA	600	FZ 6/FAZER	2004	2007	HB180	NEW
YAMAHA	600	FZ 6/FAZER	2004	2007	HB162		YAMAHA	600	FZ 6/FAZER/S2	2007	2008	HB180	NEW
YAMAHA	600	FZ 6/FAZER/S2	2007	2008	HB162		YAMAHA	600	XJ 6 / DIVERSION / SP	2009	2015	HB180	NEW
YAMAHA	600	XJ 6 / DIVERSION / SP	2009	2015	HB162		YAMAHA	600	XJ 600 N/S	1995	1997	HB180	NEW
YAMAHA	600	XJ 600 N/S	1995	1997	HB162		YAMAHA	600	XJ 600 N/S	1996	1996	HB180	NEW
YAMAHA	600	XJ 600 N/S	1996	1996	HB162		YAMAHA	600	XJ 600 N/S	1993	1996	HB180	NEW
YAMAHA	600	XJ 600 N/S	1993	1996	HB162		YAMAHA	600	XJ 600 N/S	1999	2002	HB180	NEW
YAMAHA	600	XJ 600 N/S	1999	2002	HB162		YAMAHA	600	XJ 600 N/S	1999	2002	HB180	NEW
YAMAHA	600	XJ 600 N/S	1999	2002	HB162		YAMAHA	650	XJ 650	1980	1985	HB150	
YAMAHA	600	FZS 600 FAZER	2001	2002	HB163		YAMAHA	650	XJ 650	1980	1985	HB151	
YAMAHA	600	FZ 6/FAZER	2004	2007	HB163		YAMAHA	650	XJ 650	1980	1985	HB152	
YAMAHA	600	FZ 6/FAZER/S2	2007	2008	HB163		YAMAHA	650	XJ 650	1980	1985	HB162	
YAMAHA	600	XJ 6 / DIVERSION / SP	2009	2015	HB163		YAMAHA	650	XJ 650	1980	1985	HB163	
YAMAHA	600	XJ 600 N/S	1995	1997	HB163		YAMAHA	650	XJ 650	1980	1985	HB167	
YAMAHA	600	XJ 600 N/S	1996	1996	HB163		YAMAHA	650	XJ 650	1980	1985	HB174	
YAMAHA	600	XJ 600 N/S	1993	1996	HB163		YAMAHA	650	XJ 650	1980	1985	HB175	
YAMAHA	600	XJ 600 N/S	1999	2002	HB163		YAMAHA	650	XJ 650	1980	1985	HB179	NEW
YAMAHA	600	XJ 600 N/S	1999	2002	HB163		YAMAHA	650	XJ 650	1980	1985	HB180	NEW
YAMAHA	600	FZS 600 FAZER	2001	2002	HB167		YAMAHA	650	XJ 650	1980	1985	HB180	NEW
YAMAHA	600	FZ 6/FAZER	2004	2007	HB167		YAMAHA	660	MT-03	2006	2012	HB150	
YAMAHA	600	FZ 6/FAZER/S2	2007	2008	HB167		YAMAHA	660	MT-03	2006	2012	HB151	
YAMAHA	600	XJ 6 / DIVERSION / SP	2009	2015	HB167		YAMAHA	660	MT-03	2006	2012	HB152	
YAMAHA	600	XJ 600 N/S	1995	1997	HB167		YAMAHA	660	MT-03	2006	2012	HB162	
YAMAHA	600	XJ 600 N/S	1996	1996	HB167		YAMAHA	660	MT-03	2006	2012	HB163	
YAMAHA	600	XJ 600 N/S	1993	1996	HB167		YAMAHA	660	MT-03	2006	2012	HB167	
YAMAHA	600	XJ 600 N/S	1999	2002	HB167		YAMAHA	660	MT-03	2006	2012	HB174	
YAMAHA	600	XJ 600 N/S	1999	2002	HB167		YAMAHA	660	MT-03	2006	2012	HB175	
YAMAHA	600	XJ 600 N/S	1999	2002	HB167		YAMAHA	660	MT-03	2006	2012	HB179	NEW
YAMAHA	600	FZ6	2004	2007	HB171		YAMAHA	660	MT-03	2006	2012	HB180	NEW
YAMAHA	600	FZS 600 FAZER	2001	2002	HB174		YAMAHA	660	MT-03	2006	2012	HB180	NEW
YAMAHA	600	FZ 6/FAZER	2004	2007	HB174		YAMAHA	700	MT-07	2014	2016	HB181	
YAMAHA	600	FZ 6/FAZER/S2	2007	2008	HB174		YAMAHA	700	MT-07	2014	2016	HB183	NEW
YAMAHA	600	XJ 6 / DIVERSION / SP	2009	2015	HB174		YAMAHA	800	FZ 8 / FAZER	2011	2015	HB150	
YAMAHA	600	XJ 600 N/S	1995	1997	HB174		YAMAHA	800	FZ 8 / FAZER	2011	2015	HB151	
YAMAHA	600	XJ 600 N/S	1996	1996	HB174		YAMAHA	800	FZ 8 / FAZER	2011	2015	HB152	
YAMAHA	600	XJ 600 N/S	1993	1996	HB174		YAMAHA	800	FZ 8 / FAZER	2011	2015	HB162	
YAMAHA	600	XJ 600 N/S	1999	2002	HB174		YAMAHA	800	FZ 8 / FAZER	2011	2015	HB163	
YAMAHA	600	XJ 600 N/S	1999	2002	HB174		YAMAHA	800	FZ 8 / FAZER	2011	2015	HB167	
YAMAHA	600	XJ 600 N/S	1999	2002	HB174		YAMAHA	800	FZ 8 / FAZER	2011	2015	HB174	
YAMAHA	600	FZS 600 FAZER	2001	2002	HB175		YAMAHA	800	FZ 8 / FAZER	2011	2015	HB174	
YAMAHA	600	FZ 6/FAZER	2004	2007	HB175		YAMAHA	800	FZ 8 / FAZER	2011	2015	HB175	
YAMAHA	600	FZ 6/FAZER/S2	2007	2008	HB175		YAMAHA	800	FZ 8 / FAZER	2011	2015	HB179	NEW
YAMAHA	600	XJ 6 / DIVERSION / SP	2009	2015	HB175		YAMAHA	850	TDM 850	1996	2001	HB150	
YAMAHA	600	XJ 600 N/S	1995	1997	HB175		YAMAHA	850	TDM 850	1996	1999	HB150	
YAMAHA	600	XJ 600 N/S	1996	1996	HB175		YAMAHA	850	TDM 850	1991	1993	HB150	
YAMAHA	600	XJ 600 N/S	1993	1996	HB175		YAMAHA	850	TDM 850	1991	1993	HB151	
YAMAHA	600	XJ 600 N/S	1999	2002	HB175		YAMAHA	850	TDM 850	1996	2001	HB151	
YAMAHA	600	XJ 600 N/S	1999	2002	HB175		YAMAHA	850	TDM 850	1996	1999	HB151	
YAMAHA	600	XJ 600 N/S	1999	2002	HB175		YAMAHA	850	TDM 850	1991	1993	HB152	
YAMAHA	600	FZS 600 FAZER	2001	2002	HB179	NEW	YAMAHA	850	TDM 850	1996	2001	HB152	
YAMAHA	600	FZ 6/FAZER	2004	2007	HB179	NEW	YAMAHA	850	TDM 850	1996	1999	HB152	
YAMAHA	600	FZ 6/FAZER/S2	2007	2008	HB179	NEW	YAMAHA	850	TDM 850	1991	1993	HB162	
YAMAHA	600	XJ 6 / DIVERSION / SP	2009	2015	HB179	NEW	YAMAHA	850	TDM 850	1996	2001	HB162	
YAMAHA	600	XJ 600 N/S	1995	1997	HB179	NEW	YAMAHA	850	TDM 850	1996	1999	HB162	

- BRAKE/CLUTCH MASTER CYLINDERS
- ACCESSORIES SPARE PARTS
- CNC-WORKED FLUID RESERVOIR
- FULL CLUTCH
- HYDRAULIC-CLUTCH TRANFORMATION KIT
- LEVER
- THROTTLE CONTROL
- BRAKE CALIPER
- RACING KIT
- BUTTON PANEL
- LEVER GUARD
- CLIP-ON
- STREET RACING REARSET
- FUEL CAPS
- STEERING NUT
- CRASH PADS
- PADDOCK STAND
- MIRROR COVERS
- REAR-VIEW MIRRORS
- FOG LIGHTS KIT
- HANDLEBARS ACCESSORIES
- HANDLEBARS

Marca Brand	CC	Modello Model	Dal From	Al To	Codice Code	Novità New	Marca Brand	CC	Modello Model	Dal From	Al To	Codice Code	Novità New
YAMAHA	850	TDM 850	1991	1993	HB163		YAMAHA	900	TDM 900	2006	2010	HB167	
YAMAHA	850	TDM 850	1996	2001	HB163		YAMAHA	900	TDM 900	2007	2010	HB167	
YAMAHA	850	TDM 850	1996	1999	HB163		YAMAHA	900	XJ 900	1983	1985	HB167	
YAMAHA	850	TDM 850	1991	1993	HB167		YAMAHA	900	XJ 900	1983	1985	HB167	
YAMAHA	850	TDM 850	1996	2001	HB167		YAMAHA	900	XJ 900	1983	1985	HB167	
YAMAHA	850	TDM 850	1996	1999	HB167		YAMAHA	900	XJ 900 S DIVERSION	1995	2001	HB167	
YAMAHA	850	TDM 850	1991	1993	HB174		YAMAHA	900	TDM 900	2002	2005	HB174	
YAMAHA	850	TDM 850	1996	2001	HB174		YAMAHA	900	TDM 900	2006	2010	HB174	
YAMAHA	850	TDM 850	1996	1999	HB174		YAMAHA	900	TDM 900	2007	2010	HB174	
YAMAHA	850	TDM 850	1991	1993	HB175		YAMAHA	900	XJ 900	1983	1985	HB174	
YAMAHA	850	TDM 850	1996	2001	HB175		YAMAHA	900	XJ 900	1983	1985	HB174	
YAMAHA	850	TDM 850	1996	1999	HB175		YAMAHA	900	XJ 900	1983	1985	HB174	
YAMAHA	850	TDM 850	1991	1993	HB179	NEW	YAMAHA	900	XJ 900 S DIVERSION	1995	2001	HB174	
YAMAHA	850	TDM 850	1996	2001	HB179	NEW	YAMAHA	900	TDM 900	2002	2005	HB175	
YAMAHA	850	TDM 850	1996	1999	HB179	NEW	YAMAHA	900	TDM 900	2006	2010	HB175	
YAMAHA	850	TDM 850	1991	1993	HB180	NEW	YAMAHA	900	TDM 900	2007	2010	HB175	
YAMAHA	850	TDM 850	1996	2001	HB180	NEW	YAMAHA	900	XJ 900	1983	1985	HB175	
YAMAHA	850	TDM 850	1996	1999	HB180	NEW	YAMAHA	900	XJ 900	1983	1985	HB175	
YAMAHA	850	MT-09 / SR / ST	2014	2016	HB181		YAMAHA	900	XJ 900	1983	1985	HB175	
YAMAHA	850	MT-09 / SR / ST	2014	2016	HB183	NEW	YAMAHA	900	XJ 900 S DIVERSION	1995	2001	HB175	
YAMAHA	900	TDM 900	2006	2010	HB150		YAMAHA	900	TDM 900	2002	2005	HB179	NEW
YAMAHA	900	TDM 900	2007	2010	HB150		YAMAHA	900	TDM 900	2006	2010	HB179	NEW
YAMAHA	900	TDM 900	2002	2005	HB150		YAMAHA	900	TDM 900	2007	2010	HB179	NEW
YAMAHA	900	XJ 900 S DIVERSION	1995	2001	HB150		YAMAHA	900	XJ 900	1983	1985	HB179	NEW
YAMAHA	900	XJ 900	1983	1985	HB150		YAMAHA	900	XJ 900	1983	1985	HB179	NEW
YAMAHA	900	XJ 900	1983	1985	HB150		YAMAHA	900	XJ 900	1983	1985	HB179	NEW
YAMAHA	900	XJ 900	1983	1985	HB150		YAMAHA	900	XJ 900 S DIVERSION	1995	2001	HB179	NEW
YAMAHA	900	TDM 900	2002	2005	HB151		YAMAHA	900	TDM 900	2002	2005	HB180	NEW
YAMAHA	900	TDM 900	2006	2010	HB151		YAMAHA	900	TDM 900	2006	2010	HB180	NEW
YAMAHA	900	TDM 900	2007	2010	HB151		YAMAHA	900	TDM 900	2007	2010	HB180	NEW
YAMAHA	900	XJ 900	1983	1985	HB151		YAMAHA	900	XJ 900	1983	1985	HB180	NEW
YAMAHA	900	XJ 900	1983	1985	HB151		YAMAHA	900	XJ 900	1983	1985	HB180	NEW
YAMAHA	900	XJ 900	1983	1985	HB151		YAMAHA	900	XJ 900	1983	1985	HB180	NEW
YAMAHA	900	XJ 900 S DIVERSION	1995	2001	HB151		YAMAHA	900	XJ 900 S DIVERSION	1995	2001	HB180	NEW
YAMAHA	900	TDM 900	2002	2005	HB152		YAMAHA	1000	FZ 1 / FAZER / GT	2006	2012	HB150	
YAMAHA	900	TDM 900	2006	2010	HB152		YAMAHA	1000	FZS 1000 FAZER	2001	2005	HB150	
YAMAHA	900	TDM 900	2007	2010	HB152		YAMAHA	1000	FZS 1000 FAZER	2004	2005	HB150	
YAMAHA	900	XJ 900	1983	1985	HB152		YAMAHA	1000	FZS 1000 FAZER	2001	2005	HB151	
YAMAHA	900	XJ 900	1983	1985	HB152		YAMAHA	1000	FZS 1000 FAZER	2004	2005	HB151	
YAMAHA	900	XJ 900	1983	1985	HB152		YAMAHA	1000	FZ 1 / FAZER / GT	2006	2012	HB151	
YAMAHA	900	XJ 900 S DIVERSION	1995	2001	HB152		YAMAHA	1000	FZS 1000 FAZER	2001	2005	HB152	
YAMAHA	900	TDM 900	2002	2005	HB162		YAMAHA	1000	FZS 1000 FAZER	2004	2005	HB152	
YAMAHA	900	TDM 900	2006	2010	HB162		YAMAHA	1000	FZS 1000 FAZER	2001	2005	HB152	
YAMAHA	900	TDM 900	2007	2010	HB162		YAMAHA	1000	FZ 1 / FAZER / GT	2006	2012	HB152	
YAMAHA	900	XJ 900	1983	1985	HB162		YAMAHA	1000	FZS 1000 FAZER	2001	2005	HB162	
YAMAHA	900	XJ 900	1983	1985	HB162		YAMAHA	1000	FZS 1000 FAZER	2004	2005	HB162	
YAMAHA	900	XJ 900	1983	1985	HB162		YAMAHA	1000	FZ 1 / FAZER / GT	2006	2012	HB162	
YAMAHA	900	XJ 900	1983	1985	HB162		YAMAHA	1000	FZS 1000 FAZER	2001	2005	HB163	
YAMAHA	900	XJ 900 S DIVERSION	1995	2001	HB162		YAMAHA	1000	FZS 1000 FAZER	2004	2005	HB163	
YAMAHA	900	TDM 900	2002	2005	HB163		YAMAHA	1000	FZ 1 / FAZER / GT	2006	2012	HB163	
YAMAHA	900	TDM 900	2006	2010	HB163		YAMAHA	1000	FZS 1000 FAZER	2001	2005	HB167	
YAMAHA	900	TDM 900	2007	2010	HB163		YAMAHA	1000	FZS 1000 FAZER	2004	2005	HB167	
YAMAHA	900	XJ 900	1983	1985	HB163		YAMAHA	1000	FZ 1 / FAZER / GT	2006	2012	HB167	
YAMAHA	900	XJ 900	1983	1985	HB163		YAMAHA	1000	FZS 1000 FAZER	2001	2005	HB174	
YAMAHA	900	XJ 900	1983	1985	HB163		YAMAHA	1000	FZS 1000 FAZER	2004	2005	HB174	
YAMAHA	900	XJ 900 S DIVERSION	1995	2001	HB163		YAMAHA	1000	FZ 1 / FAZER / GT	2006	2012	HB174	
YAMAHA	900	TDM 900	2002	2005	HB167		YAMAHA	1000	FZS 1000 FAZER	2001	2005	HB175	

BRAKE/CLUTCH
 MASTER CYLINDERS
 ACCESSORIES
 SPARE PARTS
 CNC-WORKED FLUID
 RESERVOIR
 FULL CLUTCH
 HYDRAULIC-CLUTCH
 TRANFORMATION KIT
 LEVER
 THROTTLE CONTROL
 BRAKE CALIPER
 RACING KIT
 BUTTON PANEL
 LEVER GUARD
 CLIP-ON
 STREET RACING
 REARSET
 FUEL CAPS
 STEERING NUT
 CRASH PADS
 PADDOCK STAND
 MIRROR COVERS
 REAR-VIEW MIRRORS
 FOG LIGHTS KIT
 HANDLEBARS
 ACCESSORIES
 HANDLEBARS

Marca Brand	CC	Modello Model	Dal From	Al To	Codice Code	Novità New	Marca Brand	CC	Modello Model	Dal From	Al To	Codice Code	Novità New
YAMAHA	1000	FZS 1000 FAZER	2004	2005	HB175		YAMAHA	1300	XJR 1300	2007	2011	HB174	
YAMAHA	1000	FZ 1 / FAZER / GT	2006	2012	HB175		YAMAHA	1300	XJR 1300	1999	2001	HB175	
YAMAHA	1000	FZS 1000 FAZER	2001	2005	HB179	NEW	YAMAHA	1300	XJR 1300	2002	2003	HB175	
YAMAHA	1000	FZS 1000 FAZER	2004	2005	HB179	NEW	YAMAHA	1300	XJR 1300	2004	2006	HB175	
YAMAHA	1000	FZ 1 / FAZER / GT	2006	2012	HB179	NEW	YAMAHA	1300	XJR 1300	2007	2011	HB175	
YAMAHA	1000	FZS 1000 FAZER	2001	2005	HB180	NEW	YAMAHA	1300	XJR 1300	1999	2001	HB179	NEW
YAMAHA	1000	FZS 1000 FAZER	2004	2005	HB180	NEW	YAMAHA	1300	XJR 1300	2002	2003	HB179	NEW
YAMAHA	1000	FZ 1 / FAZER / GT	2006	2012	HB180	NEW	YAMAHA	1300	XJR 1300	2004	2006	HB179	NEW
YAMAHA	1100	BT 1100 BULLDOG	2002	2006	HB150		YAMAHA	1300	XJR 1300	2007	2011	HB179	NEW
YAMAHA	1100	BT 1100 BULLDOG	2002	2006	HB151		YAMAHA	1300	XJR 1300	1999	2001	HB180	NEW
YAMAHA	1100	BT 1100 BULLDOG	2002	2006	HB152		YAMAHA	1300	XJR 1300	2002	2003	HB180	NEW
YAMAHA	1100	BT 1100 BULLDOG	2002	2006	HB162		YAMAHA	1300	XJR 1300	2004	2006	HB180	NEW
YAMAHA	1100	BT 1100 BULLDOG	2002	2006	HB163		YAMAHA	1300	XJR 1300	2007	2011	HB180	NEW
YAMAHA	1100	BT 1100 BULLDOG	2002	2006	HB175		YAMAHA	1700	MT-01	2007	2009	HB150	
YAMAHA	1100	BT 1100 BULLDOG	2002	2006	HB179	NEW	YAMAHA	1700	MT-01	2005	2006	HB150	
YAMAHA	1100	BT 1100 BULLDOG	2002	2006	HB180	NEW	YAMAHA	1700	MT-01	2005	2006	HB151	
YAMAHA	1200	XJR 1200	1995	1996	HB150		YAMAHA	1700	MT-01	2007	2009	HB151	
YAMAHA	1200	XJR 1200	1995	1996	HB151		YAMAHA	1700	MT-01	2005	2006	HB152	
YAMAHA	1200	XJR 1200	1995	1996	HB152		YAMAHA	1700	MT-01	2007	2009	HB152	
YAMAHA	1200	XJR 1200	1995	1996	HB162		YAMAHA	1700	MT-01	2005	2006	HB162	
YAMAHA	1200	XJR 1200	1995	1996	HB163		YAMAHA	1700	MT-01	2007	2009	HB162	
YAMAHA	1200	XJR 1200	1995	1996	HB167		YAMAHA	1700	MT-01	2005	2006	HB163	
YAMAHA	1200	XJR 1200	1995	1996	HB174		YAMAHA	1700	MT-01	2007	2009	HB163	
YAMAHA	1200	XJR 1200	1995	1996	HB175		YAMAHA	1700	MT-01	2005	2006	HB175	
YAMAHA	1200	XJR 1200	1995	1996	HB179	NEW	YAMAHA	1700	MT-01	2007	2009	HB175	
YAMAHA	1200	XJR 1200	1995	1996	HB180	NEW	YAMAHA	1700	MT-01	2005	2006	HB179	NEW
YAMAHA	1300	XJR 1300	2007	2011	HB150		YAMAHA	1700	MT-01	2007	2009	HB179	NEW
YAMAHA	1300	XJR 1300	2004	2006	HB150		YAMAHA	1700	MT-01	2005	2006	HB180	NEW
YAMAHA	1300	XJR 1300	2002	2003	HB150		YAMAHA	1700	MT-01	2007	2009	HB180	NEW
YAMAHA	1300	XJR 1300	1999	2001	HB150								
YAMAHA	1300	XJR 1300	1999	2001	HB151								
YAMAHA	1300	XJR 1300	2002	2003	HB151								
YAMAHA	1300	XJR 1300	2004	2006	HB151								
YAMAHA	1300	XJR 1300	2007	2011	HB151								
YAMAHA	1300	XJR 1300	1999	2001	HB152								
YAMAHA	1300	XJR 1300	2002	2003	HB152								
YAMAHA	1300	XJR 1300	2004	2006	HB152								
YAMAHA	1300	XJR 1300	2007	2011	HB152								
YAMAHA	1300	XJR 1300	1999	2001	HB162								
YAMAHA	1300	XJR 1300	2002	2003	HB162								
YAMAHA	1300	XJR 1300	2004	2006	HB162								
YAMAHA	1300	XJR 1300	2007	2011	HB162								
YAMAHA	1300	XJR 1300	1999	2001	HB163								
YAMAHA	1300	XJR 1300	2002	2003	HB163								
YAMAHA	1300	XJR 1300	2004	2006	HB163								
YAMAHA	1300	XJR 1300	2007	2011	HB163								
YAMAHA	1300	XJR 1300	1999	2001	HB167								
YAMAHA	1300	XJR 1300	2002	2003	HB167								
YAMAHA	1300	XJR 1300	2004	2006	HB167								
YAMAHA	1300	XJR 1300	2007	2011	HB167								
YAMAHA	1300	XJR 1300	1999	2001	HB174								
YAMAHA	1300	XJR 1300	2002	2003	HB174								
YAMAHA	1300	XJR 1300	2004	2006	HB174								

- BRAKE/CLUTCH MASTER CYLINDERS
- ACCESSORIES SPARE PARTS
- CNC-WORKED FLUID RESERVOIR
- FULL CLUTCH
- HYDRAULIC-CLUTCH TRANFORMATION KIT
- LEVER
- THROTTLE CONTROL
- BRAKE CALIPER
- RACING KIT
- BUTTON PANEL
- LEVER GUARD
- CLIP-ON
- STREET RACING REARSET
- FUEL CAPS
- STEERING NUT
- CRASH PADS
- PADDOCK STAND
- MIRROR COVERS
- REAR-VIEW MIRRORS
- FOG LIGHTS KIT
- HANDLEBARS ACCESSORIES
- HANDLEBARS



BRAKE/CLUTCH
MASTER CYLINDERS

ACCESSORIES
SPARE PARTS

CNC-WORKED FLUID
RESERVOIR

FULL CLUTCH

HYDRAULIC-CLUTCH
TRANFORMATION KIT

LEVER

THROTTLE CONTROL

BRAKE CALIPER

RACING KIT

BUTTON PANEL

LEVER GUARD

CLIP-ON

STREET RACING
REARSET

FUEL CAPS

STEERING NUT

CRASH PADS

Paddock STAND

MIRROR COVERS

REAR-VIEW MIRRORS

FOG LIGHTS KIT

HANDLEBARS
ACCESSORIES

HANDLEBARS